

O'REILLY®

Hands-on Machine Learning with Scikit-Learn, Keras & TensorFlow

Concepts, Tools, and Techniques
to Build Intelligent Systems

powered by



2nd Edition
Updated for
TensorFlow 2



**Early
Release**

**RAW &
UNEDITED**

Aurélien Géron

SECOND EDITION

Hands-on Machine Learning with Scikit-Learn, Keras, and TensorFlow

*Concepts, Tools, and Techniques to
Build Intelligent Systems*

Aurélien Géron

Beijing • Boston • Farnham • Sebastopol • Tokyo

O'REILLY[®]

Hands-on Machine Learning with Scikit-Learn, Keras, and TensorFlow

by Aurélien Géron

Copyright © 2019 Aurélien Géron. All rights reserved.

Printed in the United States of America.

Published by O'Reilly Media, Inc., 1005 Gravenstein Highway North, Sebastopol, CA 95472.

O'Reilly books may be purchased for educational, business, or sales promotional use. Online editions are also available for most titles (<http://oreilly.com>). For more information, contact our corporate/institutional sales department: 800-998-9938 or corporate@oreilly.com.

Editor: Nicole Tache

Cover Designer: Karen Montgomery

Interior Designer: David Futato

Illustrator: Rebecca Demarest

June 2019: Second Edition

Revision History for the Early Release

2018-11-05: First Release
2019-01-24: Second Release
2019-03-07: Third Release
2019-03-29: Fourth Release
2019-04-22: Fifth Release

See <http://oreilly.com/catalog/errata.csp?isbn=9781492032649> for release details.

The O'Reilly logo is a registered trademark of O'Reilly Media, Inc. *Hands-on Machine Learning with Scikit-Learn, Keras, and TensorFlow*, the cover image, and related trade dress are trademarks of O'Reilly Media, Inc.

While the publisher and the author have used good faith efforts to ensure that the information and instructions contained in this work are accurate, the publisher and the author disclaim all responsibility for errors or omissions, including without limitation responsibility for damages resulting from the use of or reliance on this work. Use of the information and instructions contained in this work is at your own risk. If any code samples or other technology this work contains or describes is subject to open source licenses or the intellectual property rights of others, it is your responsibility to ensure that your use thereof complies with such licenses and/or rights.

978-1-492-03264-9

[LSI]

Table of Contents

Preface.....	xi
--------------	----

Part I. The Fundamentals of Machine Learning

1. The Machine Learning Landscape.....	3
What Is Machine Learning?	4
Why Use Machine Learning?	4
Types of Machine Learning Systems	8
Supervised/Unsupervised Learning	8
Batch and Online Learning	15
Instance-Based Versus Model-Based Learning	18
Main Challenges of Machine Learning	24
Insufficient Quantity of Training Data	24
Nonrepresentative Training Data	26
Poor-Quality Data	27
Irrelevant Features	27
Overfitting the Training Data	28
Underfitting the Training Data	30
Stepping Back	30
Testing and Validating	31
Hyperparameter Tuning and Model Selection	32
Data Mismatch	33
Exercises	34
2. End-to-End Machine Learning Project.....	37
Working with Real Data	38
Look at the Big Picture	39

Frame the Problem	39
Select a Performance Measure	42
Check the Assumptions	45
Get the Data	45
Create the Workspace	45
Download the Data	49
Take a Quick Look at the Data Structure	50
Create a Test Set	54
Discover and Visualize the Data to Gain Insights	58
Visualizing Geographical Data	59
Looking for Correlations	62
Experimenting with Attribute Combinations	65
Prepare the Data for Machine Learning Algorithms	66
Data Cleaning	67
Handling Text and Categorical Attributes	69
Custom Transformers	71
Feature Scaling	72
Transformation Pipelines	73
Select and Train a Model	75
Training and Evaluating on the Training Set	75
Better Evaluation Using Cross-Validation	76
Fine-Tune Your Model	79
Grid Search	79
Randomized Search	81
Ensemble Methods	82
Analyze the Best Models and Their Errors	82
Evaluate Your System on the Test Set	83
Launch, Monitor, and Maintain Your System	84
Try It Out!	85
Exercises	85
3. Classification.....	87
MNIST	87
Training a Binary Classifier	90
Performance Measures	90
Measuring Accuracy Using Cross-Validation	91
Confusion Matrix	92
Precision and Recall	94
Precision/Recall Tradeoff	95
The ROC Curve	99
Multiclass Classification	102
Error Analysis	104

Multilabel Classification	108
Multioutput Classification	109
Exercises	110
4. Training Models.....	113
Linear Regression	114
The Normal Equation	116
Computational Complexity	119
Gradient Descent	119
Batch Gradient Descent	123
Stochastic Gradient Descent	126
Mini-batch Gradient Descent	129
Polynomial Regression	130
Learning Curves	132
Regularized Linear Models	136
Ridge Regression	137
Lasso Regression	139
Elastic Net	142
Early Stopping	142
Logistic Regression	144
Estimating Probabilities	144
Training and Cost Function	145
Decision Boundaries	146
Softmax Regression	149
Exercises	153
5. Support Vector Machines.....	155
Linear SVM Classification	155
Soft Margin Classification	156
Nonlinear SVM Classification	159
Polynomial Kernel	160
Adding Similarity Features	161
Gaussian RBF Kernel	162
Computational Complexity	163
SVM Regression	164
Under the Hood	166
Decision Function and Predictions	166
Training Objective	167
Quadratic Programming	169
The Dual Problem	170
Kernelized SVM	171
Online SVMs	174

Exercises	175
6. Decision Trees.....	177
Training and Visualizing a Decision Tree	177
Making Predictions	179
Estimating Class Probabilities	181
The CART Training Algorithm	182
Computational Complexity	183
Gini Impurity or Entropy?	183
Regularization Hyperparameters	184
Regression	185
Instability	188
Exercises	189
7. Ensemble Learning and Random Forests.....	191
Voting Classifiers	192
Bagging and Pasting	195
Bagging and Pasting in Scikit-Learn	196
Out-of-Bag Evaluation	197
Random Patches and Random Subspaces	198
Random Forests	199
Extra-Trees	200
Feature Importance	200
Boosting	201
AdaBoost	202
Gradient Boosting	205
Stacking	210
Exercises	213
8. Dimensionality Reduction.....	215
The Curse of Dimensionality	216
Main Approaches for Dimensionality Reduction	218
Projection	218
Manifold Learning	220
PCA	222
Preserving the Variance	222
Principal Components	223
Projecting Down to d Dimensions	224
Using Scikit-Learn	224
Explained Variance Ratio	225
Choosing the Right Number of Dimensions	225
PCA for Compression	226

Randomized PCA	227
Incremental PCA	227
Kernel PCA	228
Selecting a Kernel and Tuning Hyperparameters	229
LLE	232
Other Dimensionality Reduction Techniques	234
Exercises	235
9. Unsupervised Learning Techniques.....	237
Clustering	238
K-Means	240
Limits of K-Means	250
Using clustering for image segmentation	251
Using Clustering for Preprocessing	252
Using Clustering for Semi-Supervised Learning	254
DBSCAN	256
Other Clustering Algorithms	259
Gaussian Mixtures	260
Anomaly Detection using Gaussian Mixtures	266
Selecting the Number of Clusters	267
Bayesian Gaussian Mixture Models	270
Other Anomaly Detection and Novelty Detection Algorithms	274

Part II. Neural Networks and Deep Learning

10. Introduction to Artificial Neural Networks with Keras.....	277
From Biological to Artificial Neurons	278
Biological Neurons	279
Logical Computations with Neurons	281
The Perceptron	281
Multi-Layer Perceptron and Backpropagation	286
Regression MLPs	289
Classification MLPs	290
Implementing MLPs with Keras	292
Installing TensorFlow 2	293
Building an Image Classifier Using the Sequential API	294
Building a Regression MLP Using the Sequential API	303
Building Complex Models Using the Functional API	304
Building Dynamic Models Using the Subclassing API	309
Saving and Restoring a Model	311
Using Callbacks	311

Visualization Using TensorBoard	313
Fine-Tuning Neural Network Hyperparameters	315
Number of Hidden Layers	319
Number of Neurons per Hidden Layer	320
Learning Rate, Batch Size and Other Hyperparameters	320
Exercises	322
11. Training Deep Neural Networks.....	325
Vanishing/Exploding Gradients Problems	326
Glorot and He Initialization	327
Nonsaturating Activation Functions	329
Batch Normalization	333
Gradient Clipping	338
Reusing Pretrained Layers	339
Transfer Learning With Keras	341
Unsupervised Pretraining	343
Pretraining on an Auxiliary Task	344
Faster Optimizers	344
Momentum Optimization	345
Nesterov Accelerated Gradient	346
AdaGrad	347
RMSProp	349
Adam and Nadam Optimization	349
Learning Rate Scheduling	352
Avoiding Overfitting Through Regularization	356
ℓ_1 and ℓ_2 Regularization	356
Dropout	357
Monte-Carlo (MC) Dropout	360
Max-Norm Regularization	362
Summary and Practical Guidelines	363
Exercises	364
12. Custom Models and Training with TensorFlow.....	367
A Quick Tour of TensorFlow	368
Using TensorFlow like NumPy	371
Tensors and Operations	371
Tensors and NumPy	373
Type Conversions	374
Variables	374
Other Data Structures	375
Customizing Models and Training Algorithms	376
Custom Loss Functions	376

Saving and Loading Models That Contain Custom Components	377
Custom Activation Functions, Initializers, Regularizers, and Constraints	379
Custom Metrics	380
Custom Layers	383
Custom Models	386
Losses and Metrics Based on Model Internals	388
Computing Gradients Using Autodiff	389
Custom Training Loops	393
TensorFlow Functions and Graphs	396
Autograph and Tracing	398
TF Function Rules	400
13. Loading and Preprocessing Data with TensorFlow.....	403
The Data API	404
Chaining Transformations	405
Shuffling the Data	406
Preprocessing the Data	409
Putting Everything Together	410
Prefetching	411
Using the Dataset With tf.keras	413
The TFRecord Format	414
Compressed TFRecord Files	415
A Brief Introduction to Protocol Buffers	415
TensorFlow Protobufs	416
Loading and Parsing Examples	418
Handling Lists of Lists Using the SequenceExample Protobuf	419
The Features API	420
Categorical Features	421
Crossed Categorical Features	421
Encoding Categorical Features Using One-Hot Vectors	422
Encoding Categorical Features Using Embeddings	423
Using Feature Columns for Parsing	426
Using Feature Columns in Your Models	426
TF Transform	428
The TensorFlow Datasets (TFDS) Project	429
14. Deep Computer Vision Using Convolutional Neural Networks.....	431
The Architecture of the Visual Cortex	432
Convolutional Layer	434
Filters	436
Stacking Multiple Feature Maps	437
TensorFlow Implementation	439

Memory Requirements	441
Pooling Layer	442
TensorFlow Implementation	444
CNN Architectures	446
LeNet-5	449
AlexNet	450
GoogLeNet	452
VGGNet	456
ResNet	457
Xception	459
SENet	461
Implementing a ResNet-34 CNN Using Keras	464
Using Pretrained Models From Keras	465
Pretrained Models for Transfer Learning	467
Classification and Localization	469
Object Detection	471
Fully Convolutional Networks (FCNs)	473
You Only Look Once (YOLO)	475
Semantic Segmentation	478
Exercises	482

The Machine Learning Tsunami

In 2006, Geoffrey Hinton et al. published a paper¹ showing how to train a deep neural network capable of recognizing handwritten digits with state-of-the-art precision (>98%). They branded this technique “Deep Learning.” Training a deep neural net was widely considered impossible at the time,² and most researchers had abandoned the idea since the 1990s. This paper revived the interest of the scientific community and before long many new papers demonstrated that Deep Learning was not only possible, but capable of mind-blowing achievements that no other Machine Learning (ML) technique could hope to match (with the help of tremendous computing power and great amounts of data). This enthusiasm soon extended to many other areas of Machine Learning.

Fast-forward 10 years and Machine Learning has conquered the industry: it is now at the heart of much of the magic in today’s high-tech products, ranking your web search results, powering your smartphone’s speech recognition, recommending videos, and beating the world champion at the game of Go. Before you know it, it will be driving your car.

Machine Learning in Your Projects

So naturally you are excited about Machine Learning and you would love to join the party!

Perhaps you would like to give your homemade robot a brain of its own? Make it recognize faces? Or learn to walk around?

1 Available on Hinton’s home page at <http://www.cs.toronto.edu/~hinton/>.

2 Despite the fact that Yann Lecun’s deep convolutional neural networks had worked well for image recognition since the 1990s, although they were not as general purpose.

Or maybe your company has tons of data (user logs, financial data, production data, machine sensor data, hotline stats, HR reports, etc.), and more than likely you could unearth some hidden gems if you just knew where to look; for example:

- Segment customers and find the best marketing strategy for each group
- Recommend products for each client based on what similar clients bought
- Detect which transactions are likely to be fraudulent
- Forecast next year's revenue
- **And more**

Whatever the reason, you have decided to learn Machine Learning and implement it in your projects. Great idea!

Objective and Approach

This book assumes that you know close to nothing about Machine Learning. Its goal is to give you the concepts, the intuitions, and the tools you need to actually implement programs capable of *learning from data*.

We will cover a large number of techniques, from the simplest and most commonly used (such as linear regression) to some of the Deep Learning techniques that regularly win competitions.

Rather than implementing our own toy versions of each algorithm, we will be using actual production-ready Python frameworks:

- **Scikit-Learn** is very easy to use, yet it implements many Machine Learning algorithms efficiently, so it makes for a great entry point to learn Machine Learning.
- **TensorFlow** is a more complex library for distributed numerical computation. It makes it possible to train and run very large neural networks efficiently by distributing the computations across potentially hundreds of multi-GPU servers. TensorFlow was created at Google and supports many of their large-scale Machine Learning applications. It was open sourced in November 2015.
- **Keras** is a high level Deep Learning API that makes it very simple to train and run neural networks. It can run on top of either TensorFlow, Theano or Microsoft Cognitive Toolkit (formerly known as CNTK). TensorFlow comes with its own implementation of this API, called *tf.keras*, which provides support for some advanced TensorFlow features (e.g., to efficiently load data).

The book favors a hands-on approach, growing an intuitive understanding of Machine Learning through concrete working examples and just a little bit of theory. While you can read this book without picking up your laptop, we highly recommend

you experiment with the code examples available online as Jupyter notebooks at <https://github.com/ageron/handson-ml2>.

Prerequisites

This book assumes that you have some Python programming experience and that you are familiar with Python's main scientific libraries, in particular **NumPy**, **Pandas**, and **Matplotlib**.

Also, if you care about what's under the hood you should have a reasonable understanding of college-level math as well (calculus, linear algebra, probabilities, and statistics).

If you don't know Python yet, <http://learnpython.org/> is a great place to start. The official tutorial on python.org is also quite good.

If you have never used Jupyter, **Chapter 2** will guide you through installation and the basics: it is a great tool to have in your toolbox.

If you are not familiar with Python's scientific libraries, the provided Jupyter notebooks include a few tutorials. There is also a quick math tutorial for linear algebra.

Roadmap

This book is organized in two parts. **Part I, *The Fundamentals of Machine Learning***, covers the following topics:

- What is Machine Learning? What problems does it try to solve? What are the main categories and fundamental concepts of Machine Learning systems?
- The main steps in a typical Machine Learning project.
- Learning by fitting a model to data.
- Optimizing a cost function.
- Handling, cleaning, and preparing data.
- Selecting and engineering features.
- Selecting a model and tuning hyperparameters using cross-validation.
- The main challenges of Machine Learning, in particular underfitting and overfitting (the bias/variance tradeoff).
- Reducing the dimensionality of the training data to fight the curse of dimensionality.
- Other unsupervised learning techniques, including clustering, density estimation and anomaly detection.

- The most common learning algorithms: Linear and Polynomial Regression, Logistic Regression, k-Nearest Neighbors, Support Vector Machines, Decision Trees, Random Forests, and Ensemble methods.

Part II, *Neural Networks and Deep Learning*, covers the following topics:

- What are neural nets? What are they good for?
- Building and training neural nets using TensorFlow and Keras.
- The most important neural net architectures: feedforward neural nets, convolutional nets, recurrent nets, long short-term memory (LSTM) nets, autoencoders and generative adversarial networks (GANs).
- Techniques for training deep neural nets.
- Scaling neural networks for large datasets.
- Learning strategies with Reinforcement Learning.
- Handling uncertainty with Bayesian Deep Learning.

The first part is based mostly on Scikit-Learn while the second part uses TensorFlow and Keras.



Don't jump into deep waters too hastily: while Deep Learning is no doubt one of the most exciting areas in Machine Learning, you should master the fundamentals first. Moreover, most problems can be solved quite well using simpler techniques such as Random Forests and Ensemble methods (discussed in [Part I](#)). Deep Learning is best suited for complex problems such as image recognition, speech recognition, or natural language processing, provided you have enough data, computing power, and patience.

Other Resources

Many resources are available to learn about Machine Learning. Andrew Ng's [ML course on Coursera](#) and Geoffrey Hinton's [course on neural networks and Deep Learning](#) are amazing, although they both require a significant time investment (think months).

There are also many interesting websites about Machine Learning, including of course Scikit-Learn's exceptional [User Guide](#). You may also enjoy [Dataquest](#), which provides very nice interactive tutorials, and ML blogs such as those listed on [Quora](#). Finally, the [Deep Learning website](#) has a good list of resources to learn more.

Of course there are also many other introductory books about Machine Learning, in particular:

- Joel Grus, *Data Science from Scratch* (O'Reilly). This book presents the fundamentals of Machine Learning, and implements some of the main algorithms in pure Python (from scratch, as the name suggests).

- Stephen Marsland, *Machine Learning: An Algorithmic Perspective* (Chapman and Hall). This book is a great introduction to Machine Learning, covering a wide range of topics in depth, with code examples in Python (also from scratch, but using NumPy).
- Sebastian Raschka, *Python Machine Learning* (Packt Publishing). Also a great introduction to Machine Learning, this book leverages Python open source libraries (Pylearn 2 and Theano).
- François Chollet, *Deep Learning with Python* (Manning). A very practical book that covers a large range of topics in a clear and concise way, as you might expect from the author of the excellent Keras library. It favors code examples over mathematical theory.
- Yaser S. Abu-Mostafa, Malik Magdon-Ismael, and Hsuan-Tien Lin, *Learning from Data* (AMLBook). A rather theoretical approach to ML, this book provides deep insights, in particular on the bias/variance tradeoff (see [Chapter 4](#)).
- Stuart Russell and Peter Norvig, *Artificial Intelligence: A Modern Approach, 3rd Edition* (Pearson). This is a great (and huge) book covering an incredible amount of topics, including Machine Learning. It helps put ML into perspective.

Finally, a great way to learn is to join ML competition websites such as [Kaggle.com](#) this will allow you to practice your skills on real-world problems, with help and insights from some of the best ML professionals out there.

Conventions Used in This Book

The following typographical conventions are used in this book:

Italic

Indicates new terms, URLs, email addresses, filenames, and file extensions.

Constant width

Used for program listings, as well as within paragraphs to refer to program elements such as variable or function names, databases, data types, environment variables, statements and keywords.

Constant width bold

Shows commands or other text that should be typed literally by the user.

Constant width italic

Shows text that should be replaced with user-supplied values or by values determined by context.



This element signifies a tip or suggestion.



This element signifies a general note.



This element indicates a warning or caution.

Code Examples

Supplemental material (code examples, exercises, etc.) is available for download at <https://github.com/ageron/handson-ml2>. It is mostly composed of Jupyter notebooks.

Some of the code examples in the book leave out some repetitive sections, or details that are obvious or unrelated to Machine Learning. This keeps the focus on the important parts of the code, and it saves space to cover more topics. However, if you want the full code examples, they are all available in the Jupyter notebooks.

Note that when the code examples display some outputs, then these code examples are shown with Python prompts (`>>>` and `...`), as in a Python shell, to clearly distinguish the code from the outputs. For example, this code defines the `square()` function then it computes and displays the square of 3:

```
>>> def square(x):
...     return x ** 2
...
>>> result = square(3)
>>> result
9
```

When code does not display anything, prompts are not used. However, the result may sometimes be shown as a comment like this:

```
def square(x):
    return x ** 2

result = square(3) # result is 9
```

Using Code Examples

This book is here to help you get your job done. In general, if example code is offered with this book, you may use it in your programs and documentation. You do not need to contact us for permission unless you're reproducing a significant portion of the code. For example, writing a program that uses several chunks of code from this book does not require permission. Selling or distributing a CD-ROM of examples from O'Reilly books does require permission. Answering a question by citing this book and quoting example code does not require permission. Incorporating a significant amount of example code from this book into your product's documentation does require permission.

We appreciate, but do not require, attribution. An attribution usually includes the title, author, publisher, and ISBN. For example: "*Hands-On Machine Learning with Scikit-Learn, Keras and TensorFlow* by Aurélien Géron (O'Reilly). Copyright 2019 Aurélien Géron, 978-1-492-03264-9." If you feel your use of code examples falls outside fair use or the permission given above, feel free to contact us at permissions@oreilly.com.

O'Reilly Safari

 **Safari**[®] *Safari* (formerly Safari Books Online) is a membership-based training and reference platform for enterprise, government, educators, and individuals.

Members have access to thousands of books, training videos, Learning Paths, interactive tutorials, and curated playlists from over 250 publishers, including O'Reilly Media, Harvard Business Review, Prentice Hall Professional, Addison-Wesley Professional, Microsoft Press, Sams, Que, Peachpit Press, Adobe, Focal Press, Cisco Press, John Wiley & Sons, Syngress, Morgan Kaufmann, IBM Redbooks, Packt, Adobe Press, FT Press, Apress, Manning, New Riders, McGraw-Hill, Jones & Bartlett, and Course Technology, among others.

For more information, please visit <http://oreilly.com/safari>.

How to Contact Us

Please address comments and questions concerning this book to the publisher:

O'Reilly Media, Inc.
1005 Gravenstein Highway North
Sebastopol, CA 95472
800-998-9938 (in the United States or Canada)

707-829-0515 (international or local)
707-829-0104 (fax)

We have a web page for this book, where we list errata, examples, and any additional information. You can access this page at <http://bit.ly/hands-on-machine-learning-with-scikit-learn-and-tensorflow> or <https://homl.info/oreilly>.

To comment or ask technical questions about this book, send email to bookquestions@oreilly.com.

For more information about our books, courses, conferences, and news, see our website at <http://www.oreilly.com>.

Find us on Facebook: <http://facebook.com/oreilly>

Follow us on Twitter: <http://twitter.com/oreillymedia>

Watch us on YouTube: <http://www.youtube.com/oreillymedia>

Changes in the Second Edition

This second edition has five main objectives:

1. Cover additional topics: additional unsupervised learning techniques (including clustering, anomaly detection, density estimation and mixture models), additional techniques for training deep nets (including self-normalized networks), additional computer vision techniques (including the Xception, SENet, object detection with YOLO, and semantic segmentation using R-CNN), handling sequences using CNNs (including WaveNet), natural language processing using RNNs, CNNs and Transformers, generative adversarial networks, deploying TensorFlow models, and more.
2. Update the book to mention some of the latest results from Deep Learning research.
3. Migrate all TensorFlow chapters to TensorFlow 2, and use TensorFlow's implementation of the Keras API (called `tf.keras`) whenever possible, to simplify the code examples.
4. Update the code examples to use the latest version of Scikit-Learn, NumPy, Pandas, Matplotlib and other libraries.
5. Clarify some sections and fix some errors, thanks to plenty of great feedback from readers.

Some chapters were added, others were rewritten and a few were reordered. [Table P-1](#) shows the mapping between the 1st edition chapters and the 2nd edition chapters:

Table P-1. Chapter mapping between 1st and 2nd edition

1 st Ed. chapter	2 nd Ed. Chapter	% Changes	2 nd Ed. Title
1	1	<10%	The Machine Learning Landscape
2	2	<10%	End-to-End Machine Learning Project
3	3	<10%	Classification
4	4	<10%	Training Models
5	5	<10%	Support Vector Machines
6	6	<10%	Decision Trees
7	7	<10%	Ensemble Learning and Random Forests
8	8	<10%	Dimensionality Reduction
N/A	9	100% new	Unsupervised Learning Techniques
10	10	~75%	Introduction to Artificial Neural Networks with Keras
11	11	~50%	Training Deep Neural Networks
9	12	100% rewritten	Custom Models and Training with TensorFlow
Part of 12	13	100% rewritten	Loading and Preprocessing Data with TensorFlow
13	14	~50%	Deep Computer Vision Using Convolutional Neural Networks
Part of 14	15	~75%	Processing Sequences Using RNNs and CNNs
Part of 14	16	~90%	Natural Language Processing with RNNs and Attention
15	17	~75%	Autoencoders and GANs
16	18	~75%	Reinforcement Learning
Part of 12	19	100% rewritten	Deploying your TensorFlow Models

More specifically, here are the main changes for each 2nd edition chapter (other than clarifications, corrections and code updates):

- Chapter 1
 - Added a section on handling mismatch between the training set and the validation & test sets.
- Chapter 2
 - Added how to compute a confidence interval.
 - Improved the installation instructions (e.g., for Windows).
 - Introduced the upgraded OneHotEncoder and the new ColumnTransformer.
- Chapter 4
 - Explained the need for training instances to be Independent and Identically Distributed (IID).
- Chapter 7
 - Added a short section about XGBoost.

- Chapter 9 – new chapter including:
 - Clustering with K-Means, how to choose the number of clusters, how to use it for dimensionality reduction, semi-supervised learning, image segmentation, and more.
 - The DBSCAN clustering algorithm and an overview of other clustering algorithms available in Scikit-Learn.
 - Gaussian mixture models, the Expectation-Maximization (EM) algorithm, Bayesian variational inference, and how mixture models can be used for clustering, density estimation, anomaly detection and novelty detection.
 - Overview of other anomaly detection and novelty detection algorithms.
- Chapter 10 (mostly new)
 - Added an introduction to the Keras API, including all its APIs (Sequential, Functional and Subclassing), persistence and callbacks (including the Tensor Board callback).
- Chapter 11 (many changes)
 - Introduced self-normalizing nets, the SELU activation function and Alpha Dropout.
 - Introduced self-supervised learning.
 - Added Nadam optimization.
 - Added Monte-Carlo Dropout.
 - Added a note about the risks of adaptive optimization methods.
 - Updated the practical guidelines.
- Chapter 12 – completely rewritten chapter, including:
 - A tour of TensorFlow 2
 - TensorFlow’s lower-level Python API
 - Writing custom loss functions, metrics, layers, models
 - Using auto-differentiation and creating custom training algorithms.
 - TensorFlow Functions and graphs (including tracing and autograph).
- Chapter 13 – new chapter, including:
 - The Data API
 - Loading/Storing data efficiently using TFRecords
 - The Features API (including an introduction to embeddings).
 - An overview of TF Transform and TF Datasets
 - Moved the low-level implementation of the neural network to the exercises.

- Removed details about queues and readers that are now superseded by the Data API.
- Chapter 14
 - Added Xception and SENet architectures.
 - Added a Keras implementation of ResNet-34.
 - Showed how to use pretrained models using Keras.
 - Added an end-to-end transfer learning example.
 - Added classification and localization.
 - Introduced Fully Convolutional Networks (FCNs).
 - Introduced object detection using the YOLO architecture.
 - Introduced semantic segmentation using R-CNN.
- Chapter 15
 - Added an introduction to Wavenet.
 - Moved the Encoder–Decoder architecture and Bidirectional RNNs to Chapter 16.
- Chapter 16
 - Explained how to use the Data API to handle sequential data.
 - Showed an end-to-end example of text generation using a Character RNN, using both a stateless and a stateful RNN.
 - Showed an end-to-end example of sentiment analysis using an LSTM.
 - Explained masking in Keras.
 - Showed how to reuse pretrained embeddings using TF Hub.
 - Showed how to build an Encoder–Decoder for Neural Machine Translation using TensorFlow Addons/seq2seq.
 - Introduced beam search.
 - Explained attention mechanisms.
 - Added a short overview of visual attention and a note on explainability.
 - Introduced the fully attention-based Transformer architecture, including positional embeddings and multi-head attention.
 - Added an overview of recent language models (2018).
- Chapters 17, 18 and 19: coming soon.

Acknowledgments

Never in my wildest dreams did I imagine that the first edition of this book would get such a large audience. I received so many messages from readers, many asking questions, some kindly pointing out errata, and most sending me encouraging words. I cannot express how grateful I am to all these readers for their tremendous support. Thank you all so very much! Please do not hesitate to [file issues on github](#) if you find errors in the code examples (or just to ask questions), or to submit [errata](#) if you find errors in the text. Some readers also shared how this book helped them get their first job, or how it helped them solve a concrete problem they were working on: I find such feedback incredibly motivating. If you find this book helpful, I would love it if you could share your story with me, either privately (e.g., via [LinkedIn](#)) or publicly (e.g., in an [Amazon review](#)).

I am also incredibly thankful to all the amazing people who took time out of their busy lives to review my book with such care. In particular, I would like to thank François Chollet for reviewing all the chapters based on Keras & TensorFlow, and giving me some great, in-depth feedback. Since Keras is one of the main additions to this 2nd edition, having its author review the book was invaluable. I highly recommend François's excellent book [Deep Learning with Python](#)³: it has the conciseness, clarity and depth of the Keras library itself. Big thanks as well to Ankur Patel, who reviewed every chapter of this 2nd edition and gave me excellent feedback.

This book also benefited from plenty of help from members of the TensorFlow team, in particular Martin Wicke, who tirelessly answered dozens of my questions and dispatched the rest to the right people, including Alexandre Passos, Allen Lavoie, André Susano Pinto, Anna Revinskaya, Anthony Platanios, Clemens Mewald, Dan Moldovan, Daniel Dobson, Dustin Tran, Edd Wilder-James, Goldie Gadde, Jiri Simsa, Karmel Allison, Nick Felt, Paige Bailey, Pete Warden (who also reviewed the 1st edition), Ryan Sepassi, Sandeep Gupta, Sean Morgan, Todd Wang, Tom O'Malley, William Chargin, and Yuefeng Zhou, all of whom were tremendously helpful. A huge thank you to all of you, and to all other members of the TensorFlow team. Not just for your help, but also for making such a great library.

Big thanks to Haesun Park, who gave me plenty of excellent feedback and caught several errors while he was writing the Korean translation of the 1st edition of this book. He also translated the Jupyter notebooks to Korean, not to mention TensorFlow's documentation. I do not speak Korean, but judging by the quality of his feedback, all his translations must be truly excellent! Moreover, he kindly contributed some of the solutions to the exercises in this book.

³ "Deep Learning with Python," François Chollet (2017).

Many thanks as well to O'Reilly's fantastic staff, in particular Nicole Tache, who gave me insightful feedback, always cheerful, encouraging, and helpful: I could not dream of a better editor. Big thanks to Michele Cronin as well, who was very helpful (and patient) at the start of this 2nd edition. Thanks to Marie Beaugureau, Ben Loric, Mike Loukides, and Laurel Ruma for believing in this project and helping me define its scope. Thanks to Matt Hacker and all of the Atlas team for answering all my technical questions regarding formatting, asciidoc, and LaTeX, and thanks to Rachel Monaghan, Nick Adams, and all of the production team for their final review and their hundreds of corrections.

I would also like to thank my former Google colleagues, in particular the YouTube video classification team, for teaching me so much about Machine Learning. I could never have started the first edition without them. Special thanks to my personal ML gurus: Clément Courbet, Julien Dubois, Mathias Kende, Daniel Kitachewsky, James Pack, Alexander Pak, Anosh Raj, Vitor Sessak, Wiktor Tomczak, Ingrid von Glehn, Rich Washington, and everyone I worked with at YouTube and in the amazing Google research teams in Mountain View. All these people are just as nice and helpful as they are bright, and that's saying a lot.

I will never forget the kind people who reviewed the 1st edition of this book, including David Andrzejewski, Eddy Hung, Grégoire Mesnil, Iain Smears, Ingrid von Glehn, Justin Francis, Karim Matrah, Lukas Biewald, Michel Tessier, Salim Sémaoune, Vincent Guilbeau and of course my dear brother Sylvain.

Last but not least, I am infinitely grateful to my beloved wife, Emmanuelle, and to our three wonderful children, Alexandre, Rémi, and Gabrielle, for encouraging me to work hard on this book, as well as for their insatiable curiosity: explaining some of the most difficult concepts in this book to my wife and children helped me clarify my thoughts and directly improved many parts of this book. Plus, they keep bringing me cookies and coffee! What more can one dream of?

PART I

The Fundamentals of Machine Learning

The Machine Learning Landscape



With Early Release ebooks, you get books in their earliest form—the author’s raw and unedited content as he or she writes—so you can take advantage of these technologies long before the official release of these titles. The following will be Chapter 1 in the final release of the book.

When most people hear “Machine Learning,” they picture a robot: a dependable butler or a deadly Terminator depending on who you ask. But Machine Learning is not just a futuristic fantasy, it’s already here. In fact, it has been around for decades in some specialized applications, such as *Optical Character Recognition* (OCR). But the first ML application that really became mainstream, improving the lives of hundreds of millions of people, took over the world back in the 1990s: it was the *spam filter*. Not exactly a self-aware Skynet, but it does technically qualify as Machine Learning (it has actually learned so well that you seldom need to flag an email as spam anymore). It was followed by hundreds of ML applications that now quietly power hundreds of products and features that you use regularly, from better recommendations to voice search.

Where does Machine Learning start and where does it end? What exactly does it mean for a machine to *learn* something? If I download a copy of Wikipedia, has my computer really “learned” something? Is it suddenly smarter? In this chapter we will start by clarifying what Machine Learning is and why you may want to use it.

Then, before we set out to explore the Machine Learning continent, we will take a look at the map and learn about the main regions and the most notable landmarks: supervised versus unsupervised learning, online versus batch learning, instance-based versus model-based learning. Then we will look at the workflow of a typical ML project, discuss the main challenges you may face, and cover how to evaluate and fine-tune a Machine Learning system.

This chapter introduces a lot of fundamental concepts (and jargon) that every data scientist should know by heart. It will be a high-level overview (the only chapter without much code), all rather simple, but you should make sure everything is crystal-clear to you before continuing to the rest of the book. So grab a coffee and let's get started!



If you already know all the Machine Learning basics, you may want to skip directly to [Chapter 2](#). If you are not sure, try to answer all the questions listed at the end of the chapter before moving on.

What Is Machine Learning?

Machine Learning is the science (and art) of programming computers so they can *learn from data*.

Here is a slightly more general definition:

[Machine Learning is the] field of study that gives computers the ability to learn without being explicitly programmed.

—Arthur Samuel, 1959

And a more engineering-oriented one:

A computer program is said to learn from experience E with respect to some task T and some performance measure P , if its performance on T , as measured by P , improves with experience E .

—Tom Mitchell, 1997

For example, your spam filter is a Machine Learning program that can learn to flag spam given examples of spam emails (e.g., flagged by users) and examples of regular (nonspam, also called “ham”) emails. The examples that the system uses to learn are called the *training set*. Each training example is called a *training instance* (or *sample*). In this case, the task T is to flag spam for new emails, the experience E is the *training data*, and the performance measure P needs to be defined; for example, you can use the ratio of correctly classified emails. This particular performance measure is called *accuracy* and it is often used in classification tasks.

If you just download a copy of Wikipedia, your computer has a lot more data, but it is not suddenly better at any task. Thus, it is not Machine Learning.

Why Use Machine Learning?

Consider how you would write a spam filter using traditional programming techniques ([Figure 1-1](#)):

1. First you would look at what spam typically looks like. You might notice that some words or phrases (such as “4U,” “credit card,” “free,” and “amazing”) tend to come up a lot in the subject. Perhaps you would also notice a few other patterns in the sender’s name, the email’s body, and so on.
2. You would write a detection algorithm for each of the patterns that you noticed, and your program would flag emails as spam if a number of these patterns are detected.
3. You would test your program, and repeat steps 1 and 2 until it is good enough.

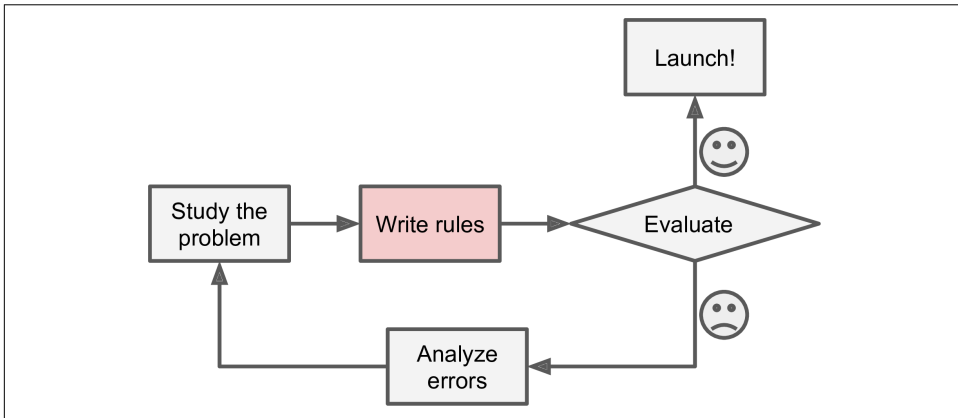

Figure 1-1. The traditional approach

Since the problem is not trivial, your program will likely become a long list of complex rules—pretty hard to maintain.

In contrast, a spam filter based on Machine Learning techniques automatically learns which words and phrases are good predictors of spam by detecting unusually frequent patterns of words in the spam examples compared to the ham examples (Figure 1-2). The program is much shorter, easier to maintain, and most likely more accurate.

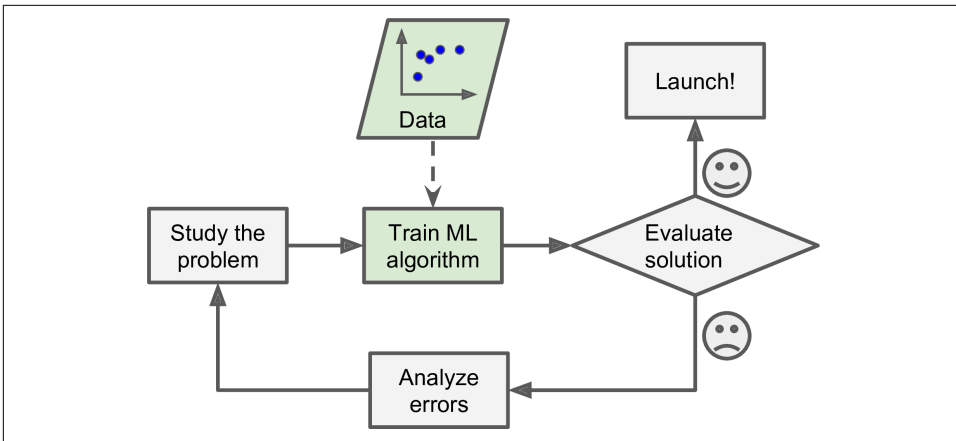

Figure 1-2. Machine Learning approach

Moreover, if spammers notice that all their emails containing “4U” are blocked, they might start writing “For U” instead. A spam filter using traditional programming techniques would need to be updated to flag “For U” emails. If spammers keep working around your spam filter, you will need to keep writing new rules forever.

In contrast, a spam filter based on Machine Learning techniques automatically notices that “For U” has become unusually frequent in spam flagged by users, and it starts flagging them without your intervention (Figure 1-3).

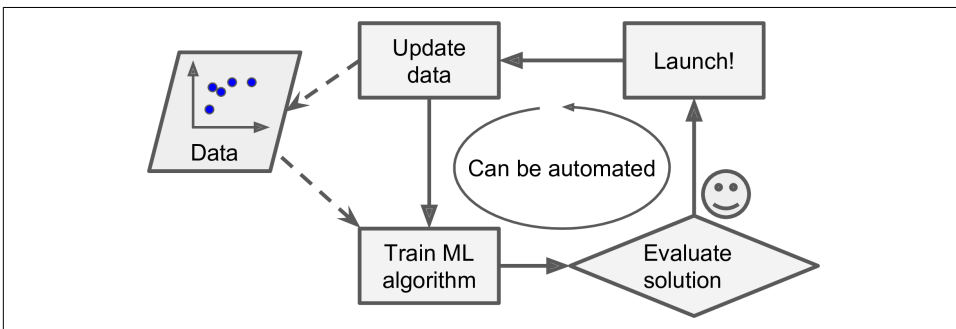

Figure 1-3. Automatically adapting to change

Another area where Machine Learning shines is for problems that either are too complex for traditional approaches or have no known algorithm. For example, consider speech recognition: say you want to start simple and write a program capable of distinguishing the words “one” and “two.” You might notice that the word “two” starts with a high-pitch sound (“T”), so you could hardcode an algorithm that measures high-pitch sound intensity and use that to distinguish ones and twos. Obviously this technique will not scale to thousands of words spoken by millions of very different

people in noisy environments and in dozens of languages. The best solution (at least today) is to write an algorithm that learns by itself, given many example recordings for each word.

Finally, Machine Learning can help humans learn (Figure 1-4): ML algorithms can be inspected to see what they have learned (although for some algorithms this can be tricky). For instance, once the spam filter has been trained on enough spam, it can easily be inspected to reveal the list of words and combinations of words that it believes are the best predictors of spam. Sometimes this will reveal unsuspected correlations or new trends, and thereby lead to a better understanding of the problem.

Applying ML techniques to dig into large amounts of data can help discover patterns that were not immediately apparent. This is called *data mining*.

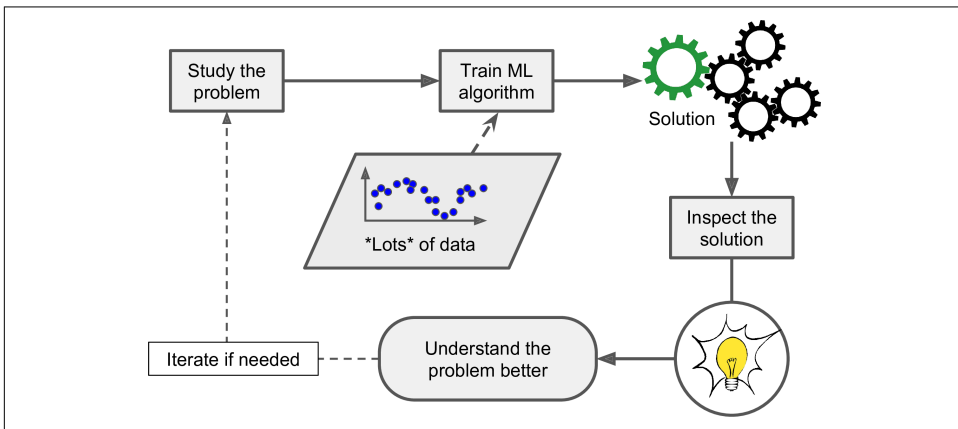

Figure 1-4. Machine Learning can help humans learn

To summarize, Machine Learning is great for:

- Problems for which existing solutions require a lot of hand-tuning or long lists of rules: one Machine Learning algorithm can often simplify code and perform better.
- Complex problems for which there is no good solution at all using a traditional approach: the best Machine Learning techniques can find a solution.
- Fluctuating environments: a Machine Learning system can adapt to new data.
- Getting insights about complex problems and large amounts of data.

Types of Machine Learning Systems

There are so many different types of Machine Learning systems that it is useful to classify them in broad categories based on:

- Whether or not they are trained with human supervision (supervised, unsupervised, semisupervised, and Reinforcement Learning)
- Whether or not they can learn incrementally on the fly (online versus batch learning)
- Whether they work by simply comparing new data points to known data points, or instead detect patterns in the training data and build a predictive model, much like scientists do (instance-based versus model-based learning)

These criteria are not exclusive; you can combine them in any way you like. For example, a state-of-the-art spam filter may learn on the fly using a deep neural network model trained using examples of spam and ham; this makes it an online, model-based, supervised learning system.

Let's look at each of these criteria a bit more closely.

Supervised/Unsupervised Learning

Machine Learning systems can be classified according to the amount and type of supervision they get during training. There are four major categories: supervised learning, unsupervised learning, semisupervised learning, and Reinforcement Learning.

Supervised learning

In *supervised learning*, the training data you feed to the algorithm includes the desired solutions, called *labels* (Figure 1-5).

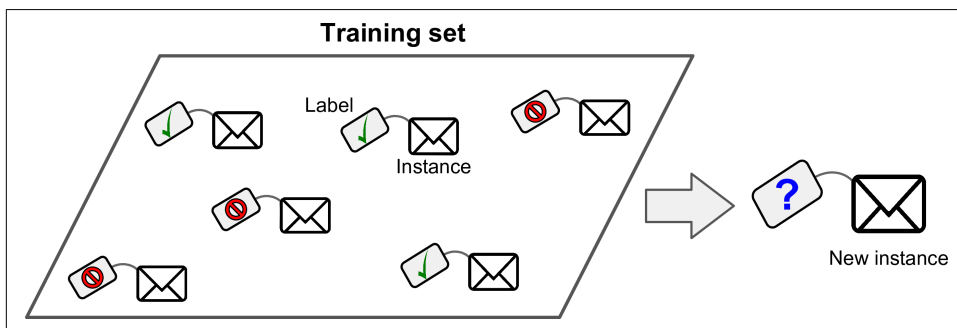

Figure 1-5. A labeled training set for supervised learning (e.g., spam classification)

A typical supervised learning task is *classification*. The spam filter is a good example of this: it is trained with many example emails along with their *class* (spam or ham), and it must learn how to classify new emails.

Another typical task is to predict a *target* numeric value, such as the price of a car, given a set of *features* (mileage, age, brand, etc.) called *predictors*. This sort of task is called *regression* (Figure 1-6).¹ To train the system, you need to give it many examples of cars, including both their predictors and their labels (i.e., their prices).



In Machine Learning an *attribute* is a data type (e.g., “Mileage”), while a *feature* has several meanings depending on the context, but generally means an attribute plus its value (e.g., “Mileage = 15,000”). Many people use the words *attribute* and *feature* interchangeably, though.

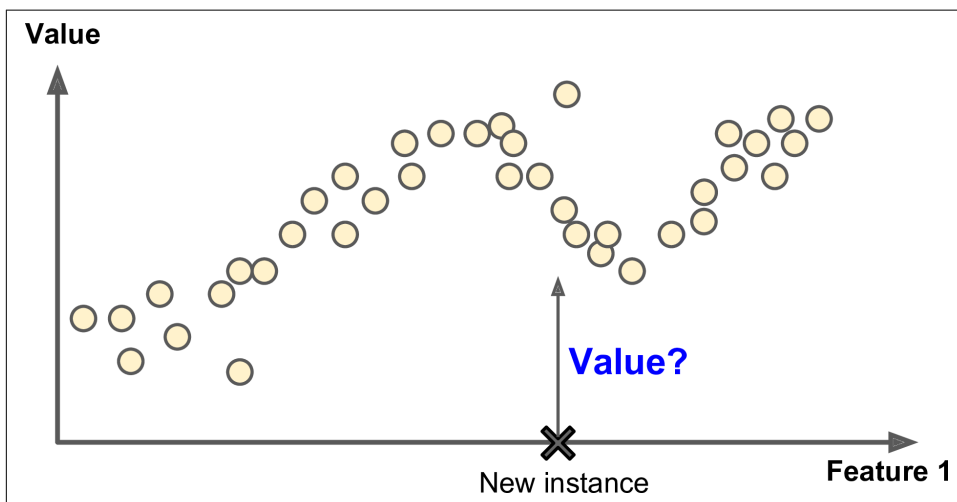

Figure 1-6. Regression

Note that some regression algorithms can be used for classification as well, and vice versa. For example, *Logistic Regression* is commonly used for classification, as it can output a value that corresponds to the probability of belonging to a given class (e.g., 20% chance of being spam).

¹ Fun fact: this odd-sounding name is a statistics term introduced by Francis Galton while he was studying the fact that the children of tall people tend to be shorter than their parents. Since children were shorter, he called this *regression to the mean*. This name was then applied to the methods he used to analyze correlations between variables.

Here are some of the most important supervised learning algorithms (covered in this book):

- k-Nearest Neighbors
- Linear Regression
- Logistic Regression
- Support Vector Machines (SVMs)
- Decision Trees and Random Forests
- Neural networks²

Unsupervised learning

In *unsupervised learning*, as you might guess, the training data is unlabeled (Figure 1-7). The system tries to learn without a teacher.

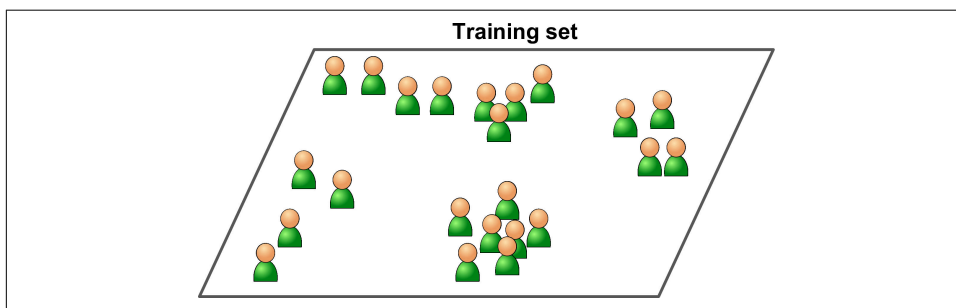

Figure 1-7. An unlabeled training set for unsupervised learning

Here are some of the most important unsupervised learning algorithms (most of these are covered in Chapter 8 and Chapter 9):

- Clustering
 - K-Means
 - DBSCAN
 - Hierarchical Cluster Analysis (HCA)
- Anomaly detection and novelty detection
 - One-class SVM
 - Isolation Forest

² Some neural network architectures can be unsupervised, such as autoencoders and restricted Boltzmann machines. They can also be semisupervised, such as in deep belief networks and unsupervised pretraining.

- Visualization and dimensionality reduction
 - Principal Component Analysis (PCA)
 - Kernel PCA
 - Locally-Linear Embedding (LLE)
 - t-distributed Stochastic Neighbor Embedding (t-SNE)
- Association rule learning
 - Apriori
 - Eclat

For example, say you have a lot of data about your blog’s visitors. You may want to run a *clustering* algorithm to try to detect groups of similar visitors (Figure 1-8). At no point do you tell the algorithm which group a visitor belongs to: it finds those connections without your help. For example, it might notice that 40% of your visitors are males who love comic books and generally read your blog in the evening, while 20% are young sci-fi lovers who visit during the weekends, and so on. If you use a *hierarchical clustering* algorithm, it may also subdivide each group into smaller groups. This may help you target your posts for each group.

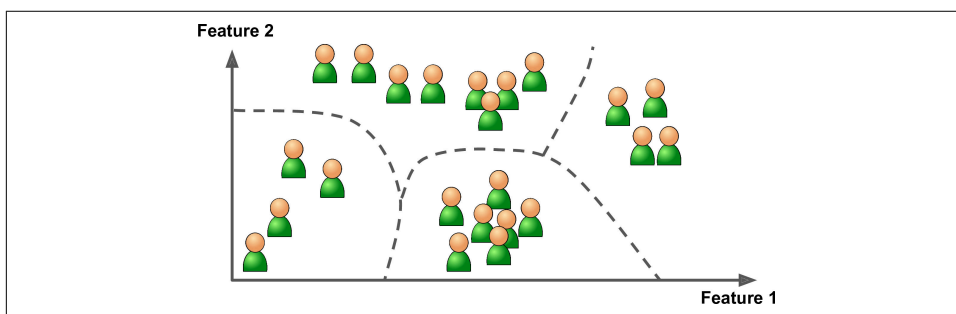

Figure 1-8. Clustering

Visualization algorithms are also good examples of unsupervised learning algorithms: you feed them a lot of complex and unlabeled data, and they output a 2D or 3D representation of your data that can easily be plotted (Figure 1-9). These algorithms try to preserve as much structure as they can (e.g., trying to keep separate clusters in the input space from overlapping in the visualization), so you can understand how the data is organized and perhaps identify unsuspected patterns.

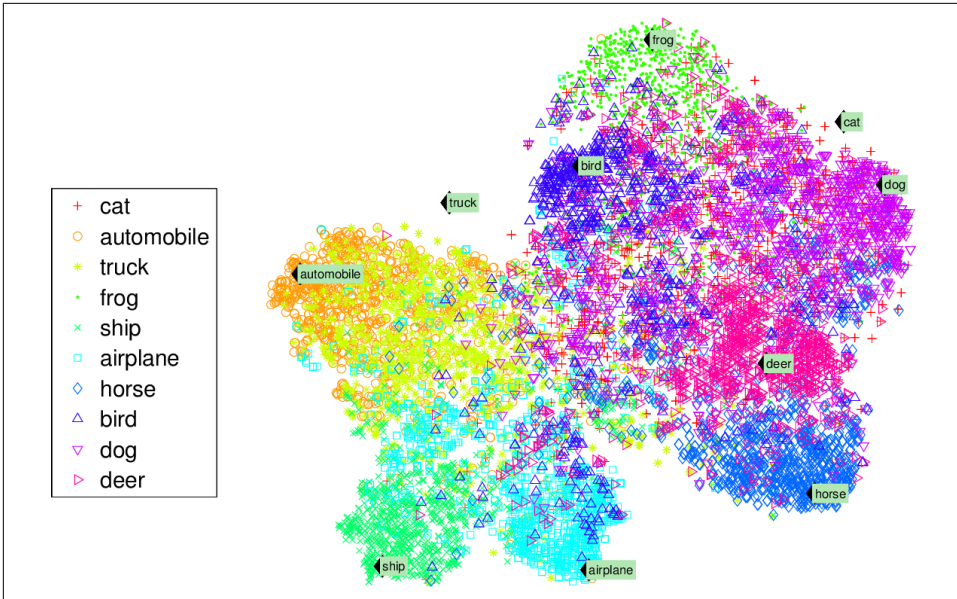

Figure 1-9. Example of a t-SNE visualization highlighting semantic clusters³

A related task is *dimensionality reduction*, in which the goal is to simplify the data without losing too much information. One way to do this is to merge several correlated features into one. For example, a car’s mileage may be very correlated with its age, so the dimensionality reduction algorithm will merge them into one feature that represents the car’s wear and tear. This is called *feature extraction*.



It is often a good idea to try to reduce the dimension of your training data using a dimensionality reduction algorithm before you feed it to another Machine Learning algorithm (such as a supervised learning algorithm). It will run much faster, the data will take up less disk and memory space, and in some cases it may also perform better.

Yet another important unsupervised task is *anomaly detection*—for example, detecting unusual credit card transactions to prevent fraud, catching manufacturing defects, or automatically removing outliers from a dataset before feeding it to another learning algorithm. The system is shown mostly normal instances during training, so it learns to recognize them and when it sees a new instance it can tell whether it looks

³ Notice how animals are rather well separated from vehicles, how horses are close to deer but far from birds, and so on. Figure reproduced with permission from Socher, Ganjoo, Manning, and Ng (2013), “T-SNE visualization of the semantic word space.”

like a normal one or whether it is likely an anomaly (see [Figure 1-10](#)). A very similar task is *novelty detection*: the difference is that novelty detection algorithms expect to see only normal data during training, while anomaly detection algorithms are usually more tolerant, they can often perform well even with a small percentage of outliers in the training set.

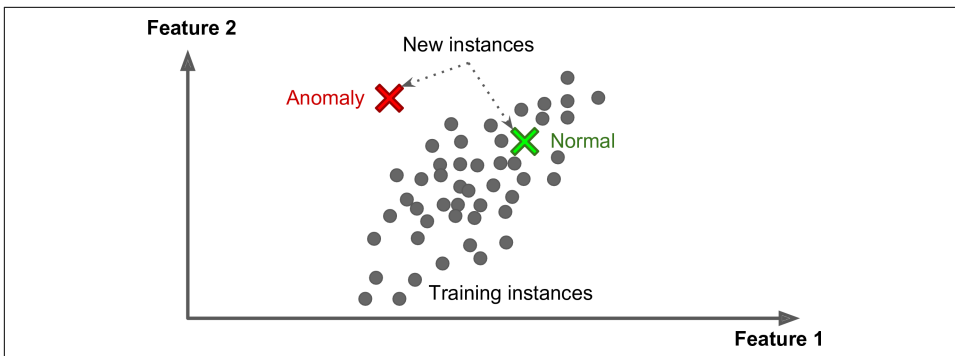

Figure 1-10. Anomaly detection

Finally, another common unsupervised task is *association rule learning*, in which the goal is to dig into large amounts of data and discover interesting relations between attributes. For example, suppose you own a supermarket. Running an association rule on your sales logs may reveal that people who purchase barbecue sauce and potato chips also tend to buy steak. Thus, you may want to place these items close to each other.

Semisupervised learning

Some algorithms can deal with partially labeled training data, usually a lot of unlabeled data and a little bit of labeled data. This is called *semisupervised learning* ([Figure 1-11](#)).

Some photo-hosting services, such as Google Photos, are good examples of this. Once you upload all your family photos to the service, it automatically recognizes that the same person A shows up in photos 1, 5, and 11, while another person B shows up in photos 2, 5, and 7. This is the unsupervised part of the algorithm (clustering). Now all the system needs is for you to tell it who these people are. Just one label per person,⁴ and it is able to name everyone in every photo, which is useful for searching photos.

⁴ That's when the system works perfectly. In practice it often creates a few clusters per person, and sometimes mixes up two people who look alike, so you need to provide a few labels per person and manually clean up some clusters.

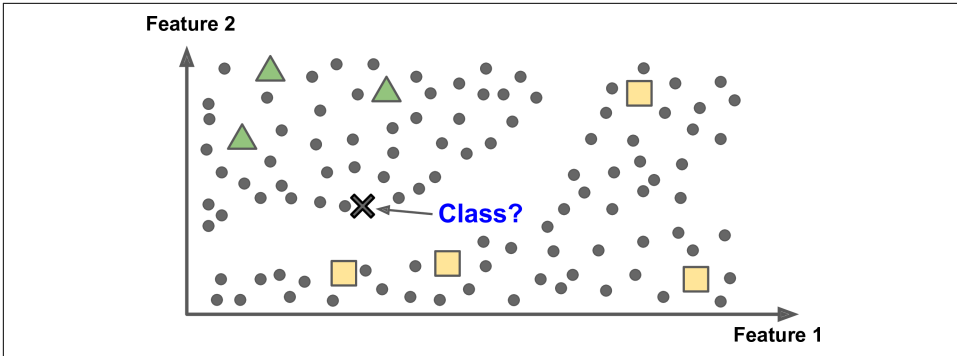

Figure 1-11. Semisupervised learning

Most semisupervised learning algorithms are combinations of unsupervised and supervised algorithms. For example, *deep belief networks* (DBNs) are based on unsupervised components called *restricted Boltzmann machines* (RBMs) stacked on top of one another. RBMs are trained sequentially in an unsupervised manner, and then the whole system is fine-tuned using supervised learning techniques.

Reinforcement Learning

Reinforcement Learning is a very different beast. The learning system, called an *agent* in this context, can observe the environment, select and perform actions, and get *rewards* in return (or *penalties* in the form of negative rewards, as in [Figure 1-12](#)). It must then learn by itself what is the best strategy, called a *policy*, to get the most reward over time. A policy defines what action the agent should choose when it is in a given situation.

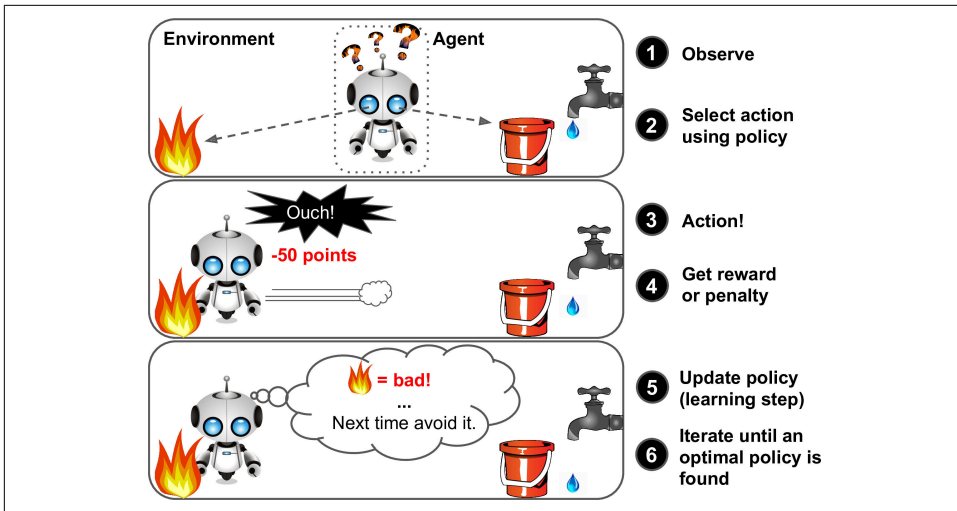

Figure 1-12. Reinforcement Learning

For example, many robots implement Reinforcement Learning algorithms to learn how to walk. DeepMind's AlphaGo program is also a good example of Reinforcement Learning: it made the headlines in May 2017 when it beat the world champion Ke Jie at the game of Go. It learned its winning policy by analyzing millions of games, and then playing many games against itself. Note that learning was turned off during the games against the champion; AlphaGo was just applying the policy it had learned.

Batch and Online Learning

Another criterion used to classify Machine Learning systems is whether or not the system can learn incrementally from a stream of incoming data.

Batch learning

In *batch learning*, the system is incapable of learning incrementally: it must be trained using all the available data. This will generally take a lot of time and computing resources, so it is typically done offline. First the system is trained, and then it is launched into production and runs without learning anymore; it just applies what it has learned. This is called *offline learning*.

If you want a batch learning system to know about new data (such as a new type of spam), you need to train a new version of the system from scratch on the full dataset (not just the new data, but also the old data), then stop the old system and replace it with the new one.

Fortunately, the whole process of training, evaluating, and launching a Machine Learning system can be automated fairly easily (as shown in [Figure 1-3](#)), so even a

batch learning system can adapt to change. Simply update the data and train a new version of the system from scratch as often as needed.

This solution is simple and often works fine, but training using the full set of data can take many hours, so you would typically train a new system only every 24 hours or even just weekly. If your system needs to adapt to rapidly changing data (e.g., to predict stock prices), then you need a more reactive solution.

Also, training on the full set of data requires a lot of computing resources (CPU, memory space, disk space, disk I/O, network I/O, etc.). If you have a lot of data and you automate your system to train from scratch every day, it will end up costing you a lot of money. If the amount of data is huge, it may even be impossible to use a batch learning algorithm.

Finally, if your system needs to be able to learn autonomously and it has limited resources (e.g., a smartphone application or a rover on Mars), then carrying around large amounts of training data and taking up a lot of resources to train for hours every day is a showstopper.

Fortunately, a better option in all these cases is to use algorithms that are capable of learning incrementally.

Online learning

In *online learning*, you train the system incrementally by feeding it data instances sequentially, either individually or by small groups called *mini-batches*. Each learning step is fast and cheap, so the system can learn about new data on the fly, as it arrives (see [Figure 1-13](#)).

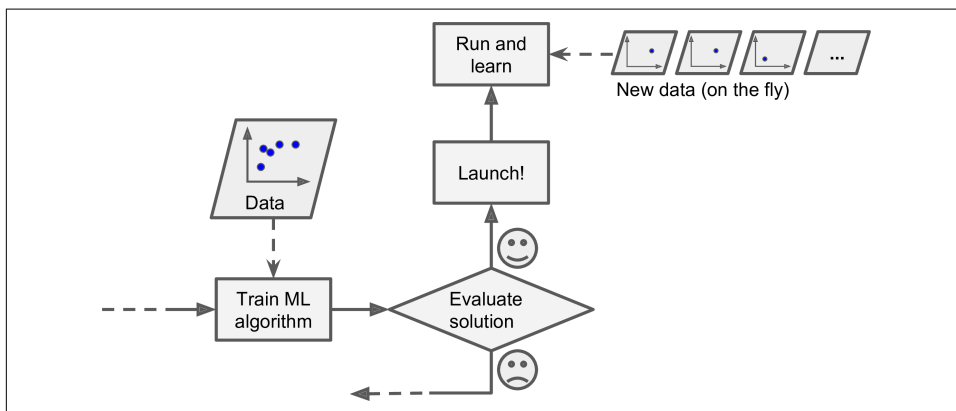

Figure 1-13. Online learning

Online learning is great for systems that receive data as a continuous flow (e.g., stock prices) and need to adapt to change rapidly or autonomously. It is also a good option

if you have limited computing resources: once an online learning system has learned about new data instances, it does not need them anymore, so you can discard them (unless you want to be able to roll back to a previous state and “replay” the data). This can save a huge amount of space.

Online learning algorithms can also be used to train systems on huge datasets that cannot fit in one machine’s main memory (this is called *out-of-core* learning). The algorithm loads part of the data, runs a training step on that data, and repeats the process until it has run on all of the data (see [Figure 1-14](#)).



Out-of-core learning is usually done offline (i.e., not on the live system), so *online learning* can be a confusing name. Think of it as *incremental learning*.

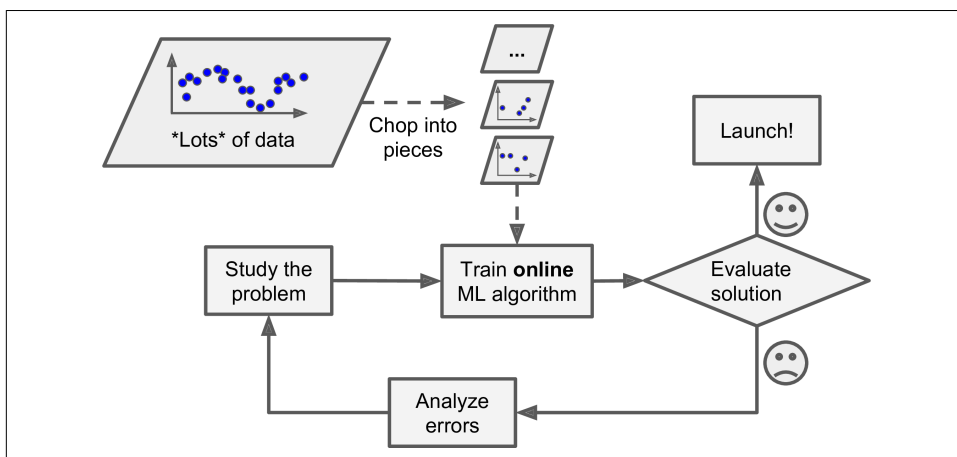

Figure 1-14. Using online learning to handle huge datasets

One important parameter of online learning systems is how fast they should adapt to changing data: this is called the *learning rate*. If you set a high learning rate, then your system will rapidly adapt to new data, but it will also tend to quickly forget the old data (you don’t want a spam filter to flag only the latest kinds of spam it was shown). Conversely, if you set a low learning rate, the system will have more inertia; that is, it will learn more slowly, but it will also be less sensitive to noise in the new data or to sequences of nonrepresentative data points (outliers).

A big challenge with online learning is that if bad data is fed to the system, the system’s performance will gradually decline. If we are talking about a live system, your clients will notice. For example, bad data could come from a malfunctioning sensor on a robot, or from someone spamming a search engine to try to rank high in search

results. To reduce this risk, you need to monitor your system closely and promptly switch learning off (and possibly revert to a previously working state) if you detect a drop in performance. You may also want to monitor the input data and react to abnormal data (e.g., using an anomaly detection algorithm).

Instance-Based Versus Model-Based Learning

One more way to categorize Machine Learning systems is by how they *generalize*. Most Machine Learning tasks are about making predictions. This means that given a number of training examples, the system needs to be able to generalize to examples it has never seen before. Having a good performance measure on the training data is good, but insufficient; the true goal is to perform well on new instances.

There are two main approaches to generalization: instance-based learning and model-based learning.

Instance-based learning

Possibly the most trivial form of learning is simply to learn by heart. If you were to create a spam filter this way, it would just flag all emails that are identical to emails that have already been flagged by users—not the worst solution, but certainly not the best.

Instead of just flagging emails that are identical to known spam emails, your spam filter could be programmed to also flag emails that are very similar to known spam emails. This requires a *measure of similarity* between two emails. A (very basic) similarity measure between two emails could be to count the number of words they have in common. The system would flag an email as spam if it has many words in common with a known spam email.

This is called *instance-based learning*: the system learns the examples by heart, then generalizes to new cases by comparing them to the learned examples (or a subset of them), using a similarity measure. For example, in [Figure 1-15](#) the new instance would be classified as a triangle because the majority of the most similar instances belong to that class.

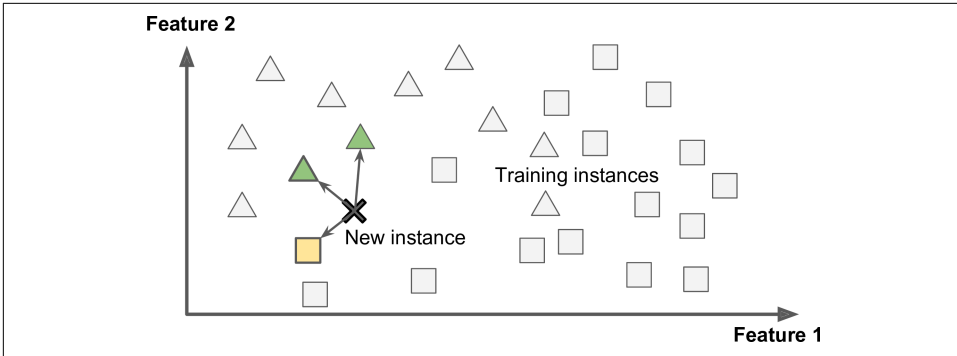

Figure 1-15. Instance-based learning

Model-based learning

Another way to generalize from a set of examples is to build a model of these examples, then use that model to make *predictions*. This is called *model-based learning* (Figure 1-16).

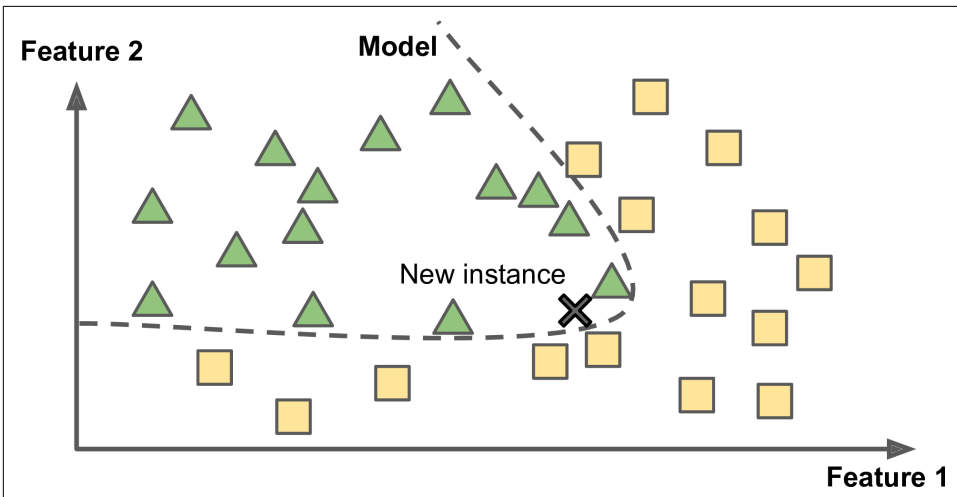

Figure 1-16. Model-based learning

For example, suppose you want to know if money makes people happy, so you download the *Better Life Index* data from the [OECD's website](#) as well as stats about GDP per capita from the [IMF's website](#). Then you join the tables and sort by GDP per capita. [Table 1-1](#) shows an excerpt of what you get.

Table 1-1. Does money make people happier?

Country	GDP per capita (USD)	Life satisfaction
Hungary	12,240	4.9
Korea	27,195	5.8
France	37,675	6.5
Australia	50,962	7.3
United States	55,805	7.2

Let's plot the data for a few random countries (Figure 1-17).

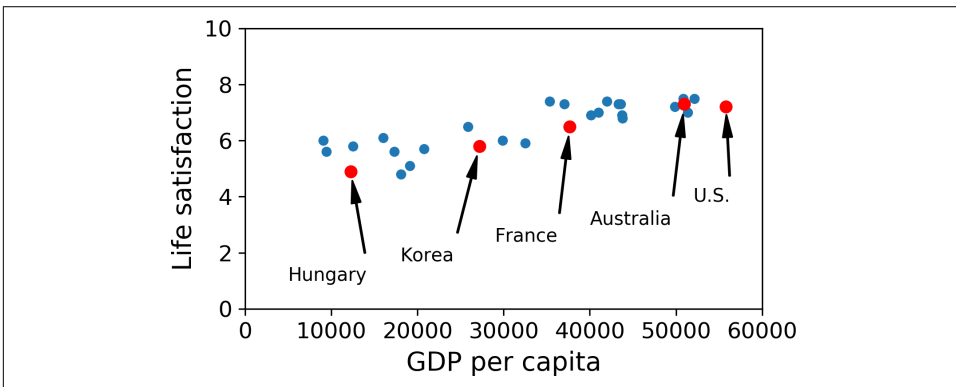

Figure 1-17. Do you see a trend here?

There does seem to be a trend here! Although the data is *noisy* (i.e., partly random), it looks like life satisfaction goes up more or less linearly as the country's GDP per capita increases. So you decide to model life satisfaction as a linear function of GDP per capita. This step is called *model selection*: you selected a *linear model* of life satisfaction with just one attribute, GDP per capita (Equation 1-1).

Equation 1-1. A simple linear model

$$\text{life_satisfaction} = \theta_0 + \theta_1 \times \text{GDP_per_capita}$$

This model has two *model parameters*, θ_0 and θ_1 .⁵ By tweaking these parameters, you can make your model represent any linear function, as shown in Figure 1-18.

⁵ By convention, the Greek letter θ (theta) is frequently used to represent model parameters.

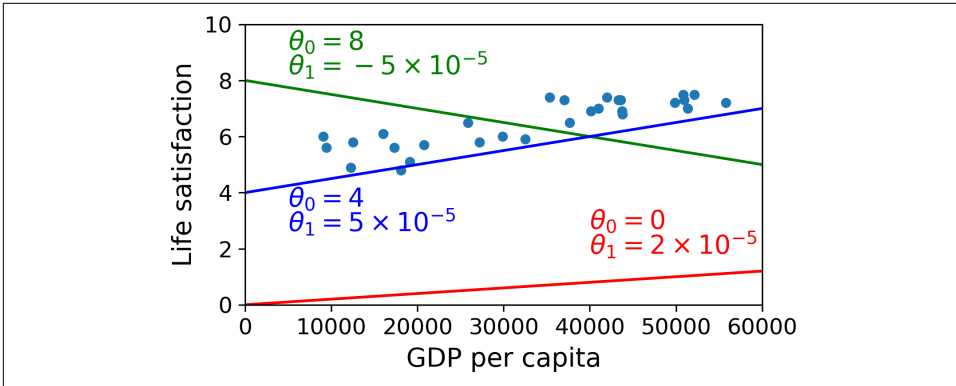

Figure 1-18. A few possible linear models

Before you can use your model, you need to define the parameter values θ_0 and θ_1 . How can you know which values will make your model perform best? To answer this question, you need to specify a performance measure. You can either define a *utility function* (or *fitness function*) that measures how *good* your model is, or you can define a *cost function* that measures how *bad* it is. For linear regression problems, people typically use a cost function that measures the distance between the linear model's predictions and the training examples; the objective is to minimize this distance.

This is where the Linear Regression algorithm comes in: you feed it your training examples and it finds the parameters that make the linear model fit best to your data. This is called *training* the model. In our case the algorithm finds that the optimal parameter values are $\theta_0 = 4.85$ and $\theta_1 = 4.91 \times 10^{-5}$.

Now the model fits the training data as closely as possible (for a linear model), as you can see in [Figure 1-19](#).

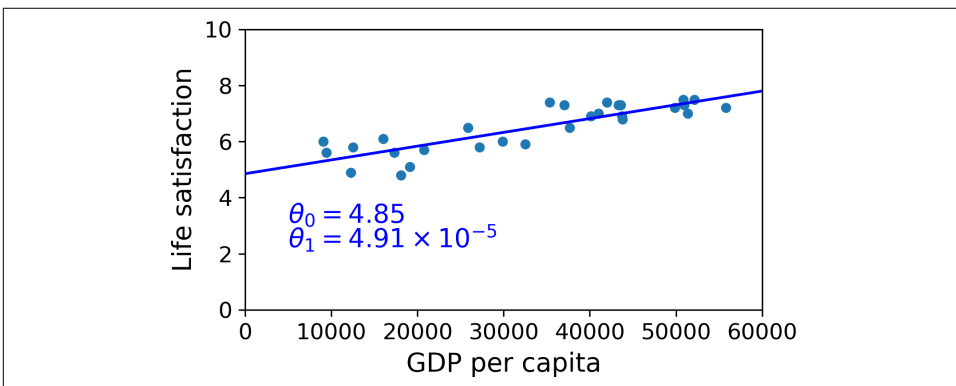

Figure 1-19. The linear model that fits the training data best

You are finally ready to run the model to make predictions. For example, say you want to know how happy Cypriots are, and the OECD data does not have the answer. Fortunately, you can use your model to make a good prediction: you look up Cyprus's GDP per capita, find \$22,587, and then apply your model and find that life satisfaction is likely to be somewhere around $4.85 + 22,587 \times 4.91 \times 10^{-5} = 5.96$.

To whet your appetite, [Example 1-1](#) shows the Python code that loads the data, prepares it,⁶ creates a scatterplot for visualization, and then trains a linear model and makes a prediction.⁷

Example 1-1. Training and running a linear model using Scikit-Learn

```
import matplotlib.pyplot as plt
import numpy as np
import pandas as pd
import sklearn.linear_model

# Load the data
oecd_bli = pd.read_csv("oecd_bli_2015.csv", thousands=',')
gdp_per_capita = pd.read_csv("gdp_per_capita.csv",thousands=',',delimiter='\t',
                             encoding='latin1', na_values="n/a")

# Prepare the data
country_stats = prepare_country_stats(oecd_bli, gdp_per_capita)
X = np.c_[country_stats["GDP per capita"]]
y = np.c_[country_stats["Life satisfaction"]]

# Visualize the data
country_stats.plot(kind='scatter', x="GDP per capita", y='Life satisfaction')
plt.show()

# Select a linear model
model = sklearn.linear_model.LinearRegression()

# Train the model
model.fit(X, y)

# Make a prediction for Cyprus
X_new = [[22587]] # Cyprus' GDP per capita
print(model.predict(X_new)) # outputs [[ 5.96242338]]
```

6 The `prepare_country_stats()` function's definition is not shown here (see this chapter's Jupyter notebook if you want all the gory details). It's just boring Pandas code that joins the life satisfaction data from the OECD with the GDP per capita data from the IMF.

7 It's okay if you don't understand all the code yet; we will present Scikit-Learn in the following chapters.



If you had used an instance-based learning algorithm instead, you would have found that Slovenia has the closest GDP per capita to that of Cyprus (\$20,732), and since the OECD data tells us that Slovenians' life satisfaction is 5.7, you would have predicted a life satisfaction of 5.7 for Cyprus. If you zoom out a bit and look at the two next closest countries, you will find Portugal and Spain with life satisfactions of 5.1 and 6.5, respectively. Averaging these three values, you get 5.77, which is pretty close to your model-based prediction. This simple algorithm is called *k-Nearest Neighbors* regression (in this example, $k = 3$).

Replacing the Linear Regression model with k-Nearest Neighbors regression in the previous code is as simple as replacing these two lines:

```
import sklearn.linear_model
model = sklearn.linear_model.LinearRegression()
```

with these two:

```
import sklearn.neighbors
model = sklearn.neighbors.KNeighborsRegressor(n_neighbors=3)
```

If all went well, your model will make good predictions. If not, you may need to use more attributes (employment rate, health, air pollution, etc.), get more or better quality training data, or perhaps select a more powerful model (e.g., a Polynomial Regression model).

In summary:

- You studied the data.
- You selected a model.
- You trained it on the training data (i.e., the learning algorithm searched for the model parameter values that minimize a cost function).
- Finally, you applied the model to make predictions on new cases (this is called *inference*), hoping that this model will generalize well.

This is what a typical Machine Learning project looks like. In [Chapter 2](#) you will experience this first-hand by going through an end-to-end project.

We have covered a lot of ground so far: you now know what Machine Learning is really about, why it is useful, what some of the most common categories of ML systems are, and what a typical project workflow looks like. Now let's look at what can go wrong in learning and prevent you from making accurate predictions.

Main Challenges of Machine Learning

In short, since your main task is to select a learning algorithm and train it on some data, the two things that can go wrong are “bad algorithm” and “bad data.” Let’s start with examples of bad data.

Insufficient Quantity of Training Data

For a toddler to learn what an apple is, all it takes is for you to point to an apple and say “apple” (possibly repeating this procedure a few times). Now the child is able to recognize apples in all sorts of colors and shapes. Genius.

Machine Learning is not quite there yet; it takes a lot of data for most Machine Learning algorithms to work properly. Even for very simple problems you typically need thousands of examples, and for complex problems such as image or speech recognition you may need millions of examples (unless you can reuse parts of an existing model).

The Unreasonable Effectiveness of Data

In a famous paper published in 2001, Microsoft researchers Michele Banko and Eric Brill showed that very different Machine Learning algorithms, including fairly simple ones, performed almost identically well on a complex problem of natural language disambiguation⁸ once they were given enough data (as you can see in Figure 1-20).

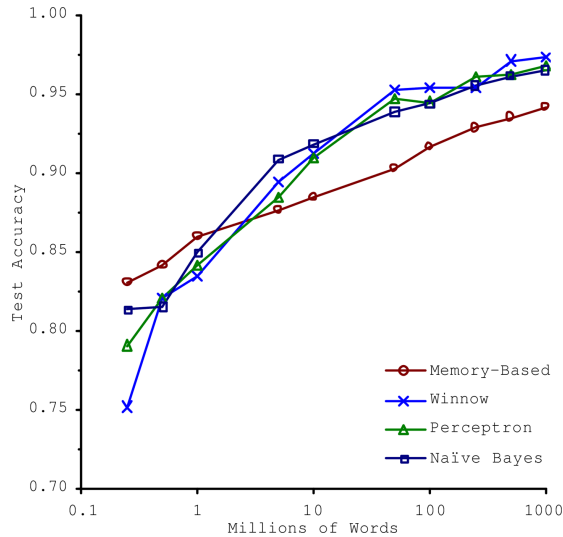

Figure 1-20. The importance of data versus algorithms⁹

As the authors put it: “these results suggest that we may want to reconsider the trade-off between spending time and money on algorithm development versus spending it on corpus development.”

The idea that data matters more than algorithms for complex problems was further popularized by Peter Norvig et al. in a paper titled “The Unreasonable Effectiveness of Data” published in 2009.¹⁰ It should be noted, however, that small- and medium-sized datasets are still very common, and it is not always easy or cheap to get extra training data, so don’t abandon algorithms just yet.

⁸ For example, knowing whether to write “to,” “two,” or “too” depending on the context.

⁹ Figure reproduced with permission from Banko and Brill (2001), “Learning Curves for Confusion Set Disambiguation.”

¹⁰ “The Unreasonable Effectiveness of Data,” Peter Norvig et al. (2009).

Nonrepresentative Training Data

In order to generalize well, it is crucial that your training data be representative of the new cases you want to generalize to. This is true whether you use instance-based learning or model-based learning.

For example, the set of countries we used earlier for training the linear model was not perfectly representative; a few countries were missing. Figure 1-21 shows what the data looks like when you add the missing countries.

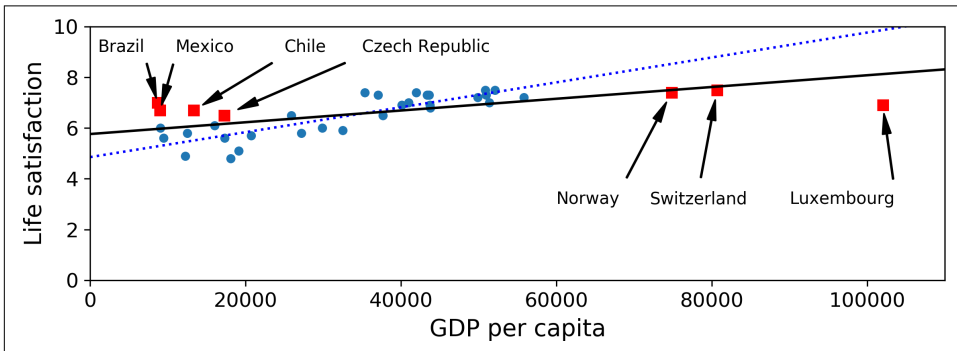

Figure 1-21. A more representative training sample

If you train a linear model on this data, you get the solid line, while the old model is represented by the dotted line. As you can see, not only does adding a few missing countries significantly alter the model, but it makes it clear that such a simple linear model is probably never going to work well. It seems that very rich countries are not happier than moderately rich countries (in fact they seem unhappier), and conversely some poor countries seem happier than many rich countries.

By using a nonrepresentative training set, we trained a model that is unlikely to make accurate predictions, especially for very poor and very rich countries.

It is crucial to use a training set that is representative of the cases you want to generalize to. This is often harder than it sounds: if the sample is too small, you will have *sampling noise* (i.e., nonrepresentative data as a result of chance), but even very large samples can be nonrepresentative if the sampling method is flawed. This is called *sampling bias*.

A Famous Example of Sampling Bias

Perhaps the most famous example of sampling bias happened during the US presidential election in 1936, which pitted Landon against Roosevelt: the *Literary Digest* conducted a very large poll, sending mail to about 10 million people. It got 2.4 million answers, and predicted with high confidence that Landon would get 57% of the votes.

Instead, Roosevelt won with 62% of the votes. The flaw was in the *Literary Digest's* sampling method:

- First, to obtain the addresses to send the polls to, the *Literary Digest* used telephone directories, lists of magazine subscribers, club membership lists, and the like. All of these lists tend to favor wealthier people, who are more likely to vote Republican (hence Landon).
- Second, less than 25% of the people who received the poll answered. Again, this introduces a sampling bias, by ruling out people who don't care much about politics, people who don't like the *Literary Digest*, and other key groups. This is a special type of sampling bias called *nonresponse bias*.

Here is another example: say you want to build a system to recognize funk music videos. One way to build your training set is to search “funk music” on YouTube and use the resulting videos. But this assumes that YouTube's search engine returns a set of videos that are representative of all the funk music videos on YouTube. In reality, the search results are likely to be biased toward popular artists (and if you live in Brazil you will get a lot of “funk carioca” videos, which sound nothing like James Brown). On the other hand, how else can you get a large training set?

Poor-Quality Data

Obviously, if your training data is full of errors, outliers, and noise (e.g., due to poor-quality measurements), it will make it harder for the system to detect the underlying patterns, so your system is less likely to perform well. It is often well worth the effort to spend time cleaning up your training data. The truth is, most data scientists spend a significant part of their time doing just that. For example:

- If some instances are clearly outliers, it may help to simply discard them or try to fix the errors manually.
- If some instances are missing a few features (e.g., 5% of your customers did not specify their age), you must decide whether you want to ignore this attribute altogether, ignore these instances, fill in the missing values (e.g., with the median age), or train one model with the feature and one model without it, and so on.

Irrelevant Features

As the saying goes: garbage in, garbage out. Your system will only be capable of learning if the training data contains enough relevant features and not too many irrelevant ones. A critical part of the success of a Machine Learning project is coming up with a good set of features to train on. This process, called *feature engineering*, involves:

- *Feature selection*: selecting the most useful features to train on among existing features.
- *Feature extraction*: combining existing features to produce a more useful one (as we saw earlier, dimensionality reduction algorithms can help).
- Creating new features by gathering new data.

Now that we have looked at many examples of bad data, let's look at a couple of examples of bad algorithms.

Overfitting the Training Data

Say you are visiting a foreign country and the taxi driver rips you off. You might be tempted to say that *all* taxi drivers in that country are thieves. Overgeneralizing is something that we humans do all too often, and unfortunately machines can fall into the same trap if we are not careful. In Machine Learning this is called *overfitting*: it means that the model performs well on the training data, but it does not generalize well.

Figure 1-22 shows an example of a high-degree polynomial life satisfaction model that strongly overfits the training data. Even though it performs much better on the training data than the simple linear model, would you really trust its predictions?

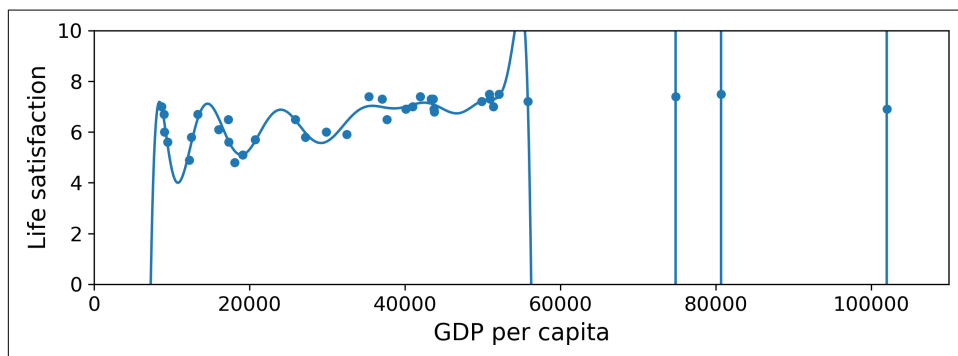

Figure 1-22. Overfitting the training data

Complex models such as deep neural networks can detect subtle patterns in the data, but if the training set is noisy, or if it is too small (which introduces sampling noise), then the model is likely to detect patterns in the noise itself. Obviously these patterns will not generalize to new instances. For example, say you feed your life satisfaction model many more attributes, including uninformative ones such as the country's name. In that case, a complex model may detect patterns like the fact that all countries in the training data with a *w* in their name have a life satisfaction greater than 7: New Zealand (7.3), Norway (7.4), Sweden (7.2), and Switzerland (7.5). How confident

are you that the W -satisfaction rule generalizes to Rwanda or Zimbabwe? Obviously this pattern occurred in the training data by pure chance, but the model has no way to tell whether a pattern is real or simply the result of noise in the data.



Overfitting happens when the model is too complex relative to the amount and noisiness of the training data. The possible solutions are:

- To simplify the model by selecting one with fewer parameters (e.g., a linear model rather than a high-degree polynomial model), by reducing the number of attributes in the training data or by constraining the model
- To gather more training data
- To reduce the noise in the training data (e.g., fix data errors and remove outliers)

Constraining a model to make it simpler and reduce the risk of overfitting is called *regularization*. For example, the linear model we defined earlier has two parameters, θ_0 and θ_1 . This gives the learning algorithm two *degrees of freedom* to adapt the model to the training data: it can tweak both the height (θ_0) and the slope (θ_1) of the line. If we forced $\theta_1 = 0$, the algorithm would have only one degree of freedom and would have a much harder time fitting the data properly: all it could do is move the line up or down to get as close as possible to the training instances, so it would end up around the mean. A very simple model indeed! If we allow the algorithm to modify θ_1 but we force it to keep it small, then the learning algorithm will effectively have somewhere in between one and two degrees of freedom. It will produce a simpler model than with two degrees of freedom, but more complex than with just one. You want to find the right balance between fitting the training data perfectly and keeping the model simple enough to ensure that it will generalize well.

Figure 1-23 shows three models: the dotted line represents the original model that was trained with a few countries missing, the dashed line is our second model trained with all countries, and the solid line is a linear model trained with the same data as the first model but with a regularization constraint. You can see that regularization forced the model to have a smaller slope, which fits a bit less the training data that the model was trained on, but actually allows it to generalize better to new examples.

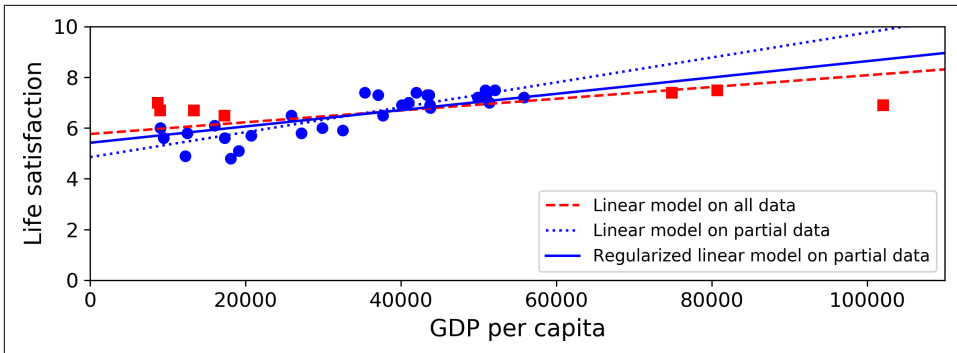

Figure 1-23. Regularization reduces the risk of overfitting

The amount of regularization to apply during learning can be controlled by a *hyperparameter*. A hyperparameter is a parameter of a learning algorithm (not of the model). As such, it is not affected by the learning algorithm itself; it must be set prior to training and remains constant during training. If you set the regularization hyperparameter to a very large value, you will get an almost flat model (a slope close to zero); the learning algorithm will almost certainly not overfit the training data, but it will be less likely to find a good solution. Tuning hyperparameters is an important part of building a Machine Learning system (you will see a detailed example in the next chapter).

Underfitting the Training Data

As you might guess, *underfitting* is the opposite of overfitting: it occurs when your model is too simple to learn the underlying structure of the data. For example, a linear model of life satisfaction is prone to underfit; reality is just more complex than the model, so its predictions are bound to be inaccurate, even on the training examples.

The main options to fix this problem are:

- Selecting a more powerful model, with more parameters
- Feeding better features to the learning algorithm (feature engineering)
- Reducing the constraints on the model (e.g., reducing the regularization hyperparameter)

Stepping Back

By now you already know a lot about Machine Learning. However, we went through so many concepts that you may be feeling a little lost, so let's step back and look at the big picture:

- Machine Learning is about making machines get better at some task by learning from data, instead of having to explicitly code rules.
- There are many different types of ML systems: supervised or not, batch or online, instance-based or model-based, and so on.
- In a ML project you gather data in a training set, and you feed the training set to a learning algorithm. If the algorithm is model-based it tunes some parameters to fit the model to the training set (i.e., to make good predictions on the training set itself), and then hopefully it will be able to make good predictions on new cases as well. If the algorithm is instance-based, it just learns the examples by heart and generalizes to new instances by comparing them to the learned instances using a similarity measure.
- The system will not perform well if your training set is too small, or if the data is not representative, noisy, or polluted with irrelevant features (garbage in, garbage out). Lastly, your model needs to be neither too simple (in which case it will underfit) nor too complex (in which case it will overfit).

There's just one last important topic to cover: once you have trained a model, you don't want to just "hope" it generalizes to new cases. You want to evaluate it, and fine-tune it if necessary. Let's see how.

Testing and Validating

The only way to know how well a model will generalize to new cases is to actually try it out on new cases. One way to do that is to put your model in production and monitor how well it performs. This works well, but if your model is horribly bad, your users will complain—not the best idea.

A better option is to split your data into two sets: the *training set* and the *test set*. As these names imply, you train your model using the training set, and you test it using the test set. The error rate on new cases is called the *generalization error* (or *out-of-sample error*), and by evaluating your model on the test set, you get an estimate of this error. This value tells you how well your model will perform on instances it has never seen before.

If the training error is low (i.e., your model makes few mistakes on the training set) but the generalization error is high, it means that your model is overfitting the training data.



It is common to use 80% of the data for training and *hold out* 20% for testing. However, this depends on the size of the dataset: if it contains 10 million instances, then holding out 1% means your test set will contain 100,000 instances: that's probably more than enough to get a good estimate of the generalization error.

Hyperparameter Tuning and Model Selection

So evaluating a model is simple enough: just use a test set. Now suppose you are hesitating between two models (say a linear model and a polynomial model): how can you decide? One option is to train both and compare how well they generalize using the test set.

Now suppose that the linear model generalizes better, but you want to apply some regularization to avoid overfitting. The question is: how do you choose the value of the regularization hyperparameter? One option is to train 100 different models using 100 different values for this hyperparameter. Suppose you find the best hyperparameter value that produces a model with the lowest generalization error, say just 5% error.

So you launch this model into production, but unfortunately it does not perform as well as expected and produces 15% errors. What just happened?

The problem is that you measured the generalization error multiple times on the test set, and you adapted the model and hyperparameters to produce the best model *for that particular set*. This means that the model is unlikely to perform as well on new data.

A common solution to this problem is called *holdout validation*: you simply hold out part of the training set to evaluate several candidate models and select the best one. The new heldout set is called the *validation set* (or sometimes the *development set*, or *dev set*). More specifically, you train multiple models with various hyperparameters on the reduced training set (i.e., the full training set minus the validation set), and you select the model that performs best on the validation set. After this holdout validation process, you train the best model on the full training set (including the validation set), and this gives you the final model. Lastly, you evaluate this final model on the test set to get an estimate of the generalization error.

This solution usually works quite well. However, if the validation set is too small, then model evaluations will be imprecise: you may end up selecting a suboptimal model by mistake. Conversely, if the validation set is too large, then the remaining training set will be much smaller than the full training set. Why is this bad? Well, since the final model will be trained on the full training set, it is not ideal to compare candidate models trained on a much smaller training set. It would be like selecting the fastest sprinter to participate in a marathon. One way to solve this problem is to perform repeated *cross-validation*, using many small validation sets. Each model is evaluated once per validation set, after it is trained on the rest of the data. By averaging out all the evaluations of a model, we get a much more accurate measure of its performance. However, there is a drawback: the training time is multiplied by the number of validation sets.

Data Mismatch

In some cases, it is easy to get a large amount of data for training, but it is not perfectly representative of the data that will be used in production. For example, suppose you want to create a mobile app to take pictures of flowers and automatically determine their species. You can easily download millions of pictures of flowers on the web, but they won't be perfectly representative of the pictures that will actually be taken using the app on a mobile device. Perhaps you only have 10,000 representative pictures (i.e., actually taken with the app). In this case, the most important rule to remember is that the validation set and the test must be as representative as possible of the data you expect to use in production, so they should be composed exclusively of representative pictures: you can shuffle them and put half in the validation set, and half in the test set (making sure that no duplicates or near-duplicates end up in both sets). After training your model on the web pictures, if you observe that the performance of your model on the validation set is disappointing, you will not know whether this is because your model has overfit the training set, or whether this is just due to the mismatch between the web pictures and the mobile app pictures. One solution is to hold out part of the training pictures (from the web) in yet another set that Andrew Ng calls the *train-dev set*. After the model is trained (on the training set, *not* on the train-dev set), you can evaluate it on the train-dev set: if it performs well, then the model is not overfitting the training set, so if performs poorly on the validation set, the problem must come from the data mismatch. You can try to tackle this problem by preprocessing the web images to make them look more like the pictures that will be taken by the mobile app, and then retraining the model. Conversely, if the model performs poorly on the train-dev set, then the model must have overfit the training set, so you should try to simplify or regularize the model, get more training data and clean up the training data, as discussed earlier.

No Free Lunch Theorem

A model is a simplified version of the observations. The simplifications are meant to discard the superfluous details that are unlikely to generalize to new instances. However, to decide what data to discard and what data to keep, you must make *assumptions*. For example, a linear model makes the assumption that the data is fundamentally linear and that the distance between the instances and the straight line is just noise, which can safely be ignored.

In a [famous 1996 paper](#),¹¹ David Wolpert demonstrated that if you make absolutely no assumption about the data, then there is no reason to prefer one model over any other. This is called the *No Free Lunch* (NFL) theorem. For some datasets the best

¹¹ "The Lack of A Priori Distinctions Between Learning Algorithms," D. Wolpert (1996).

model is a linear model, while for other datasets it is a neural network. There is no model that is *a priori* guaranteed to work better (hence the name of the theorem). The only way to know for sure which model is best is to evaluate them all. Since this is not possible, in practice you make some reasonable assumptions about the data and you evaluate only a few reasonable models. For example, for simple tasks you may evaluate linear models with various levels of regularization, and for a complex problem you may evaluate various neural networks.

Exercises

In this chapter we have covered some of the most important concepts in Machine Learning. In the next chapters we will dive deeper and write more code, but before we do, make sure you know how to answer the following questions:

1. How would you define Machine Learning?
2. Can you name four types of problems where it shines?
3. What is a labeled training set?
4. What are the two most common supervised tasks?
5. Can you name four common unsupervised tasks?
6. What type of Machine Learning algorithm would you use to allow a robot to walk in various unknown terrains?
7. What type of algorithm would you use to segment your customers into multiple groups?
8. Would you frame the problem of spam detection as a supervised learning problem or an unsupervised learning problem?
9. What is an online learning system?
10. What is out-of-core learning?
11. What type of learning algorithm relies on a similarity measure to make predictions?
12. What is the difference between a model parameter and a learning algorithm's hyperparameter?
13. What do model-based learning algorithms search for? What is the most common strategy they use to succeed? How do they make predictions?
14. Can you name four of the main challenges in Machine Learning?
15. If your model performs great on the training data but generalizes poorly to new instances, what is happening? Can you name three possible solutions?
16. What is a test set and why would you want to use it?

17. What is the purpose of a validation set?
18. What can go wrong if you tune hyperparameters using the test set?
19. What is repeated cross-validation and why would you prefer it to using a single validation set?

Solutions to these exercises are available in [???](#).

End-to-End Machine Learning Project



With Early Release ebooks, you get books in their earliest form—the author’s raw and unedited content as he or she writes—so you can take advantage of these technologies long before the official release of these titles. The following will be Chapter 2 in the final release of the book.

In this chapter, you will go through an example project end to end, pretending to be a recently hired data scientist in a real estate company.¹ Here are the main steps you will go through:

1. Look at the big picture.
2. Get the data.
3. Discover and visualize the data to gain insights.
4. Prepare the data for Machine Learning algorithms.
5. Select a model and train it.
6. Fine-tune your model.
7. Present your solution.
8. Launch, monitor, and maintain your system.

¹ The example project is completely fictitious; the goal is just to illustrate the main steps of a Machine Learning project, not to learn anything about the real estate business.

Working with Real Data

When you are learning about Machine Learning it is best to actually experiment with real-world data, not just artificial datasets. Fortunately, there are thousands of open datasets to choose from, ranging across all sorts of domains. Here are a few places you can look to get data:

- Popular open data repositories:
 - [UC Irvine Machine Learning Repository](#)
 - [Kaggle datasets](#)
 - [Amazon's AWS datasets](#)
- Meta portals (they list open data repositories):
 - <http://dataportals.org/>
 - <http://opendatamonitor.eu/>
 - <http://quandl.com/>
- Other pages listing many popular open data repositories:
 - [Wikipedia's list of Machine Learning datasets](#)
 - [Quora.com question](#)
 - [Datasets subreddit](#)

In this chapter we chose the California Housing Prices dataset from the StatLib repository² (see [Figure 2-1](#)). This dataset was based on data from the 1990 California census. It is not exactly recent (you could still afford a nice house in the Bay Area at the time), but it has many qualities for learning, so we will pretend it is recent data. We also added a categorical attribute and removed a few features for teaching purposes.

² The original dataset appeared in R. Kelley Pace and Ronald Barry, "Sparse Spatial Autoregressions," *Statistics & Probability Letters* 33, no. 3 (1997): 291–297.

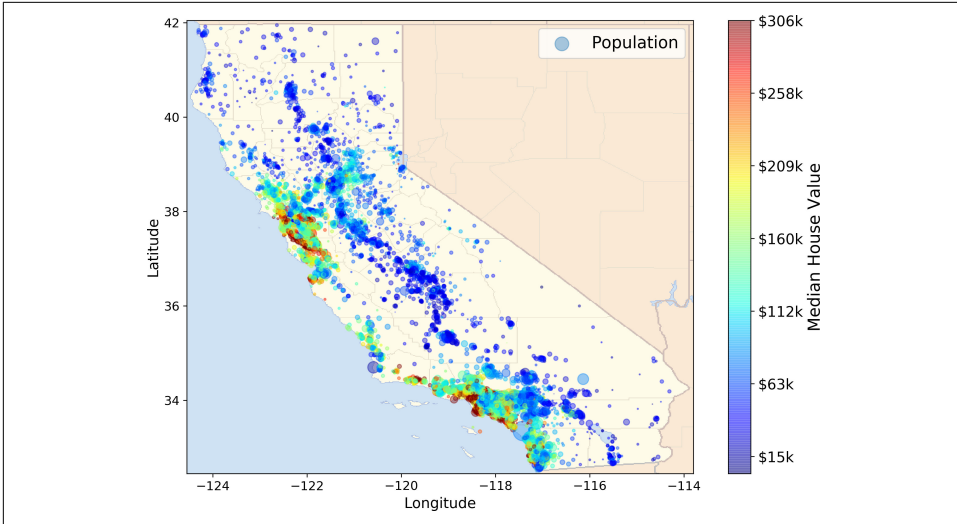

Figure 2-1. California housing prices

Look at the Big Picture

Welcome to Machine Learning Housing Corporation! The first task you are asked to perform is to build a model of housing prices in California using the California census data. This data has metrics such as the population, median income, median housing price, and so on for each block group in California. Block groups are the smallest geographical unit for which the US Census Bureau publishes sample data (a block group typically has a population of 600 to 3,000 people). We will just call them “districts” for short.

Your model should learn from this data and be able to predict the median housing price in any district, given all the other metrics.



Since you are a well-organized data scientist, the first thing you do is to pull out your Machine Learning project checklist. You can start with the one in ???; it should work reasonably well for most Machine Learning projects but make sure to adapt it to your needs. In this chapter we will go through many checklist items, but we will also skip a few, either because they are self-explanatory or because they will be discussed in later chapters.

Frame the Problem

The first question to ask your boss is what exactly is the business objective; building a model is probably not the end goal. How does the company expect to use and benefit

from this model? This is important because it will determine how you frame the problem, what algorithms you will select, what performance measure you will use to evaluate your model, and how much effort you should spend tweaking it.

Your boss answers that your model's output (a prediction of a district's median housing price) will be fed to another Machine Learning system (see [Figure 2-2](#)), along with many other *signals*.³ This downstream system will determine whether it is worth investing in a given area or not. Getting this right is critical, as it directly affects revenue.

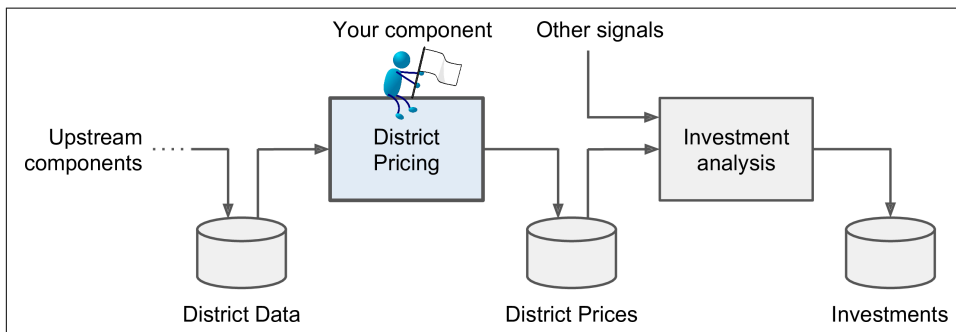

Figure 2-2. A Machine Learning pipeline for real estate investments

Pipelines

A sequence of data processing *components* is called a data *pipeline*. Pipelines are very common in Machine Learning systems, since there is a lot of data to manipulate and many data transformations to apply.

Components typically run asynchronously. Each component pulls in a large amount of data, processes it, and spits out the result in another data store, and then some time later the next component in the pipeline pulls this data and spits out its own output, and so on. Each component is fairly self-contained: the interface between components is simply the data store. This makes the system quite simple to grasp (with the help of a data flow graph), and different teams can focus on different components. Moreover, if a component breaks down, the downstream components can often continue to run normally (at least for a while) by just using the last output from the broken component. This makes the architecture quite robust.

³ A piece of information fed to a Machine Learning system is often called a *signal* in reference to Shannon's information theory: you want a high signal/noise ratio.

On the other hand, a broken component can go unnoticed for some time if proper monitoring is not implemented. The data gets stale and the overall system's performance drops.

The next question to ask is what the current solution looks like (if any). It will often give you a reference performance, as well as insights on how to solve the problem. Your boss answers that the district housing prices are currently estimated manually by experts: a team gathers up-to-date information about a district, and when they cannot get the median housing price, they estimate it using complex rules.

This is costly and time-consuming, and their estimates are not great; in cases where they manage to find out the actual median housing price, they often realize that their estimates were off by more than 20%. This is why the company thinks that it would be useful to train a model to predict a district's median housing price given other data about that district. The census data looks like a great dataset to exploit for this purpose, since it includes the median housing prices of thousands of districts, as well as other data.

Okay, with all this information you are now ready to start designing your system. First, you need to frame the problem: is it supervised, unsupervised, or Reinforcement Learning? Is it a classification task, a regression task, or something else? Should you use batch learning or online learning techniques? Before you read on, pause and try to answer these questions for yourself.

Have you found the answers? Let's see: it is clearly a typical supervised learning task since you are given *labeled* training examples (each instance comes with the expected output, i.e., the district's median housing price). Moreover, it is also a typical regression task, since you are asked to predict a value. More specifically, this is a *multiple regression* problem since the system will use multiple features to make a prediction (it will use the district's population, the median income, etc.). It is also a *univariate regression* problem since we are only trying to predict a single value for each district. If we were trying to predict multiple values per district, it would be a *multivariate regression* problem. Finally, there is no continuous flow of data coming in the system, there is no particular need to adjust to changing data rapidly, and the data is small enough to fit in memory, so plain batch learning should do just fine.



If the data was huge, you could either split your batch learning work across multiple servers (using the *MapReduce* technique), or you could use an online learning technique instead.

Select a Performance Measure

Your next step is to select a performance measure. A typical performance measure for regression problems is the Root Mean Square Error (RMSE). It gives an idea of how much error the system typically makes in its predictions, with a higher weight for large errors. [Equation 2-1](#) shows the mathematical formula to compute the RMSE.

Equation 2-1. Root Mean Square Error (RMSE)

$$\text{RMSE}(\mathbf{X}, h) = \sqrt{\frac{1}{m} \sum_{i=1}^m (h(\mathbf{x}^{(i)}) - y^{(i)})^2}$$

Notations

This equation introduces several very common Machine Learning notations that we will use throughout this book:

- m is the number of instances in the dataset you are measuring the RMSE on.
 - For example, if you are evaluating the RMSE on a validation set of 2,000 districts, then $m = 2,000$.
- $\mathbf{x}^{(i)}$ is a vector of all the feature values (excluding the label) of the i^{th} instance in the dataset, and $y^{(i)}$ is its label (the desired output value for that instance).
 - For example, if the first district in the dataset is located at longitude -118.29° , latitude 33.91° , and it has 1,416 inhabitants with a median income of \$38,372, and the median house value is \$156,400 (ignoring the other features for now), then:

$$\mathbf{x}^{(1)} = \begin{pmatrix} -118.29 \\ 33.91 \\ 1,416 \\ 38,372 \end{pmatrix}$$

and:

$$y^{(1)} = 156,400$$

- \mathbf{X} is a matrix containing all the feature values (excluding labels) of all instances in the dataset. There is one row per instance and the i^{th} row is equal to the transpose of $\mathbf{x}^{(i)}$, noted $(\mathbf{x}^{(i)})^T$.
 - For example, if the first district is as just described, then the matrix \mathbf{X} looks like this:

$$\mathbf{X} = \begin{pmatrix} (\mathbf{x}^{(1)})^T \\ (\mathbf{x}^{(2)})^T \\ \vdots \\ (\mathbf{x}^{(1999)})^T \\ (\mathbf{x}^{(2000)})^T \end{pmatrix} = \begin{pmatrix} -118.29 & 33.91 & 1,416 & 38,372 \\ \vdots & \vdots & \vdots & \vdots \end{pmatrix}$$

4 Recall that the transpose operator flips a column vector into a row vector (and vice versa).

- h is your system's prediction function, also called a *hypothesis*. When your system is given an instance's feature vector $\mathbf{x}^{(i)}$, it outputs a predicted value $\hat{y}^{(i)} = h(\mathbf{x}^{(i)})$ for that instance (\hat{y} is pronounced "y-hat").
 - For example, if your system predicts that the median housing price in the first district is \$158,400, then $\hat{y}^{(1)} = h(\mathbf{x}^{(1)}) = 158,400$. The prediction error for this district is $\hat{y}^{(1)} - y^{(1)} = 2,000$.
- $\text{RMSE}(\mathbf{X}, h)$ is the cost function measured on the set of examples using your hypothesis h .

We use lowercase italic font for scalar values (such as m or $y^{(i)}$) and function names (such as h), lowercase bold font for vectors (such as $\mathbf{x}^{(i)}$), and uppercase bold font for matrices (such as \mathbf{X}).

Even though the RMSE is generally the preferred performance measure for regression tasks, in some contexts you may prefer to use another function. For example, suppose that there are many outlier districts. In that case, you may consider using the *Mean Absolute Error* (also called the Average Absolute Deviation; see [Equation 2-2](#)):

Equation 2-2. Mean Absolute Error

$$\text{MAE}(\mathbf{X}, h) = \frac{1}{m} \sum_{i=1}^m |h(\mathbf{x}^{(i)}) - y^{(i)}|$$

Both the RMSE and the MAE are ways to measure the distance between two vectors: the vector of predictions and the vector of target values. Various distance measures, or *norms*, are possible:

- Computing the root of a sum of squares (RMSE) corresponds to the *Euclidean norm*: it is the notion of distance you are familiar with. It is also called the ℓ_2 norm, noted $\|\cdot\|_2$ (or just $\|\cdot\|$).
- Computing the sum of absolutes (MAE) corresponds to the ℓ_1 norm, noted $\|\cdot\|_1$. It is sometimes called the *Manhattan norm* because it measures the distance between two points in a city if you can only travel along orthogonal city blocks.
- More generally, the ℓ_k norm of a vector \mathbf{v} containing n elements is defined as $\|\mathbf{v}\|_k = \left(|v_0|^k + |v_1|^k + \dots + |v_n|^k\right)^{\frac{1}{k}}$. ℓ_0 just gives the number of non-zero elements in the vector, and ℓ_∞ gives the maximum absolute value in the vector.
- The higher the norm index, the more it focuses on large values and neglects small ones. This is why the RMSE is more sensitive to outliers than the MAE. But when

outliers are exponentially rare (like in a bell-shaped curve), the RMSE performs very well and is generally preferred.

Check the Assumptions

Lastly, it is good practice to list and verify the assumptions that were made so far (by you or others); this can catch serious issues early on. For example, the district prices that your system outputs are going to be fed into a downstream Machine Learning system, and we assume that these prices are going to be used as such. But what if the downstream system actually converts the prices into categories (e.g., “cheap,” “medium,” or “expensive”) and then uses those categories instead of the prices themselves? In this case, getting the price perfectly right is not important at all; your system just needs to get the category right. If that’s so, then the problem should have been framed as a classification task, not a regression task. You don’t want to find this out after working on a regression system for months.

Fortunately, after talking with the team in charge of the downstream system, you are confident that they do indeed need the actual prices, not just categories. Great! You’re all set, the lights are green, and you can start coding now!

Get the Data

It’s time to get your hands dirty. Don’t hesitate to pick up your laptop and walk through the following code examples in a Jupyter notebook. The full Jupyter notebook is available at <https://github.com/ageron/handson-ml2>.

Create the Workspace

First you will need to have Python installed. It is probably already installed on your system. If not, you can get it at <https://www.python.org/>.⁵

Next you need to create a workspace directory for your Machine Learning code and datasets. Open a terminal and type the following commands (after the \$ prompts):

```
$ export ML_PATH="$HOME/ml"      # You can change the path if you prefer
$ mkdir -p $ML_PATH
```

You will need a number of Python modules: Jupyter, NumPy, Pandas, Matplotlib, and Scikit-Learn. If you already have Jupyter running with all these modules installed, you can safely skip to “[Download the Data](#)” on [page 49](#). If you don’t have them yet, there are many ways to install them (and their dependencies). You can use your sys-

⁵ The latest version of Python 3 is recommended. Python 2.7+ may work too, but it is now deprecated, all major scientific libraries are dropping support for it, so you should migrate to Python 3 as soon as possible.

tem's packaging system (e.g., apt-get on Ubuntu, or MacPorts or HomeBrew on MacOS), install a Scientific Python distribution such as Anaconda and use its packaging system, or just use Python's own packaging system, pip, which is included by default with the Python binary installers (since Python 2.7.9).⁶ You can check to see if pip is installed by typing the following command:

```
$ python3 -m pip --version
pip 19.0.2 from [...] /lib/python3.6/site-packages (python 3.6)
```

You should make sure you have a recent version of pip installed. To upgrade the pip module, type:⁷

```
$ python3 -m pip install --user -U pip
Collecting pip
[...]
Successfully installed pip-19.0.2
```

Creating an Isolated Environment

If you would like to work in an isolated environment (which is strongly recommended so you can work on different projects without having conflicting library versions), install virtualenv⁸ by running the following pip command (again, if you want virtualenv to be installed for all users on your machine, remove --user and run this command with administrator rights):

```
$ python3 -m pip install --user -U virtualenv
Collecting virtualenv
[...]
Successfully installed virtualenv
```

Now you can create an isolated Python environment by typing:

```
$ cd $ML_PATH
$ virtualenv env
Using base prefix '['...']'
New python executable in [...] /ml/env/bin/python3.6
Also creating executable in [...] /ml/env/bin/python
Installing setuptools, pip, wheel...done.
```

6 We will show the installation steps using pip in a bash shell on a Linux or MacOS system. You may need to adapt these commands to your own system. On Windows, we recommend installing Anaconda instead.

7 If you want to upgrade pip for all users on your machine rather than just your own user, you should remove the --user option and make sure you have administrator rights (e.g., by adding sudo before the whole command on Linux or MacOSX).

8 Alternative tools include venv (very similar to virtualenv and included in the standard library), virtualenv-wrapper (provides extra functionalities on top of virtualenv), pyenv (allows easy switching between Python versions), and pipenv (a great packaging tool by the same author as the popular requests library, built on top of pip, virtualenv and more).

Now every time you want to activate this environment, just open a terminal and type:

```
$ cd $ML_PATH
$ source env/bin/activate # on Linux or MacOSX
$ .\env\Scripts\activate # on Windows
```

To deactivate this environment, just type `deactivate`. While the environment is active, any package you install using `pip` will be installed in this isolated environment, and Python will only have access to these packages (if you also want access to the system's packages, you should create the environment using `virtualenv's --system-site-packages` option). Check out `virtualenv's` documentation for more information.

Now you can install all the required modules and their dependencies using this simple `pip` command (if you are not using a `virtualenv`, you will need the `--user` option or administrator rights):

```
$ python3 -m pip install -U jupyter matplotlib numpy pandas scipy scikit-learn
Collecting jupyter
  Downloading jupyter-1.0.0-py2.py3-none-any.whl
Collecting matplotlib
[...]
```

To check your installation, try to import every module like this:

```
$ python3 -c "import jupyter, matplotlib, numpy, pandas, scipy, sklearn"
```

There should be no output and no error. Now you can fire up Jupyter by typing:

```
$ jupyter notebook
[I 15:24 NotebookApp] Serving notebooks from local directory: [...]ml
[I 15:24 NotebookApp] 0 active kernels
[I 15:24 NotebookApp] The Jupyter Notebook is running at: http://localhost:8888/
[I 15:24 NotebookApp] Use Control-C to stop this server and shut down all
kernels (twice to skip confirmation).
```

A Jupyter server is now running in your terminal, listening to port 8888. You can visit this server by opening your web browser to <http://localhost:8888/> (this usually happens automatically when the server starts). You should see your empty workspace directory (containing only the `env` directory if you followed the preceding `virtualenv` instructions).

Now create a new Python notebook by clicking on the New button and selecting the appropriate Python version⁹ (see [Figure 2-3](#)).

This does three things: first, it creates a new notebook file called `Untitled.ipynb` in your workspace; second, it starts a Jupyter Python kernel to run this notebook; and

⁹ Note that Jupyter can handle multiple versions of Python, and even many other languages such as R or Octave.

third, it opens this notebook in a new tab. You should start by renaming this notebook to “Housing” (this will automatically rename the file to *Housing.ipynb*) by clicking Untitled and typing the new name.

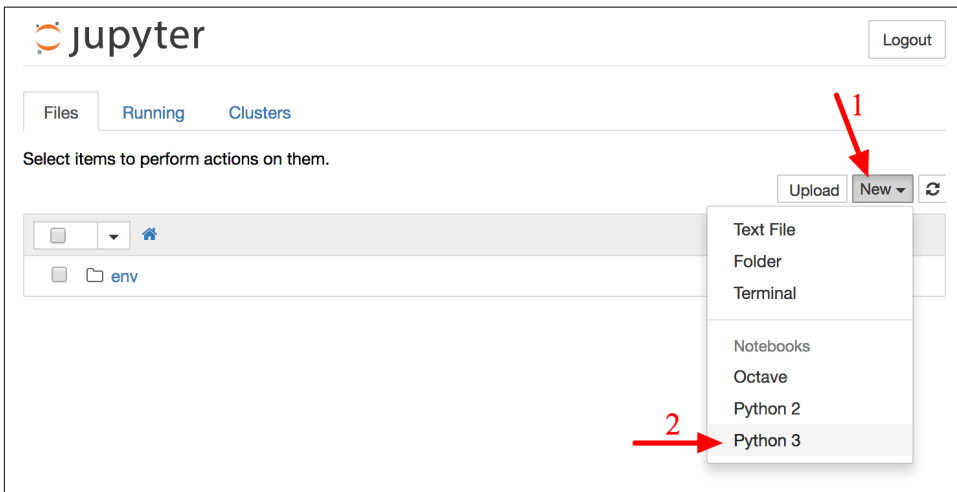

Figure 2-3. Your workspace in Jupyter

A notebook contains a list of cells. Each cell can contain executable code or formatted text. Right now the notebook contains only one empty code cell, labeled “In [1]:”. Try typing `print("Hello world!")` in the cell, and click on the play button (see Figure 2-4) or press Shift-Enter. This sends the current cell to this notebook’s Python kernel, which runs it and returns the output. The result is displayed below the cell, and since we reached the end of the notebook, a new cell is automatically created. Go through the User Interface Tour from Jupyter’s Help menu to learn the basics.

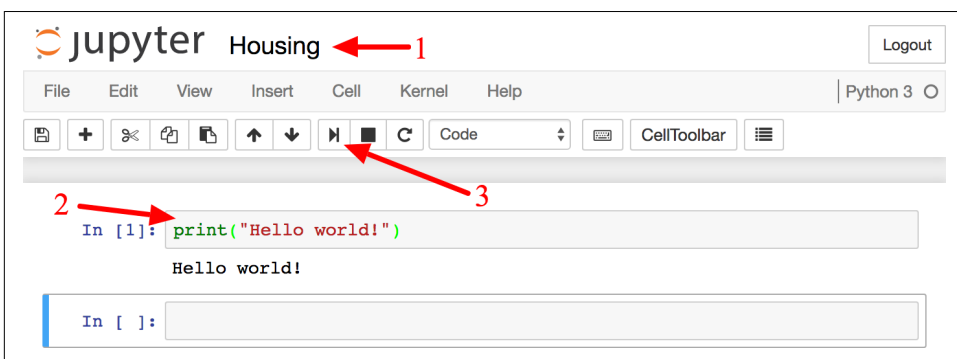

Figure 2-4. Hello world Python notebook

Download the Data

In typical environments your data would be available in a relational database (or some other common datastore) and spread across multiple tables/documents/files. To access it, you would first need to get your credentials and access authorizations,¹⁰ and familiarize yourself with the data schema. In this project, however, things are much simpler: you will just download a single compressed file, *housing.tgz*, which contains a comma-separated value (CSV) file called *housing.csv* with all the data.

You could use your web browser to download it, and run `tar xzf housing.tgz` to decompress the file and extract the CSV file, but it is preferable to create a small function to do that. It is useful in particular if data changes regularly, as it allows you to write a small script that you can run whenever you need to fetch the latest data (or you can set up a scheduled job to do that automatically at regular intervals). Automating the process of fetching the data is also useful if you need to install the dataset on multiple machines.

Here is the function to fetch the data:¹¹

```
import os
import tarfile
from six.moves import urllib

DOWNLOAD_ROOT = "https://raw.githubusercontent.com/ageron/handson-ml2/master/"
HOUSING_PATH = os.path.join("datasets", "housing")
HOUSING_URL = DOWNLOAD_ROOT + "datasets/housing/housing.tgz"

def fetch_housing_data(housing_url=HOUSING_URL, housing_path=HOUSING_PATH):
    if not os.path.isdir(housing_path):
        os.makedirs(housing_path)
    tgz_path = os.path.join(housing_path, "housing.tgz")
    urllib.request.urlretrieve(housing_url, tgz_path)
    housing_tgz = tarfile.open(tgz_path)
    housing_tgz.extractall(path=housing_path)
    housing_tgz.close()
```

Now when you call `fetch_housing_data()`, it creates a *datasets/housing* directory in your workspace, downloads the *housing.tgz* file, and extracts the *housing.csv* from it in this directory.

Now let's load the data using Pandas. Once again you should write a small function to load the data:

10 You might also need to check legal constraints, such as private fields that should never be copied to unsafe datastores.

11 In a real project you would save this code in a Python file, but for now you can just write it in your Jupyter notebook.

```
import pandas as pd

def load_housing_data(housing_path=HOUSING_PATH):
    csv_path = os.path.join(housing_path, "housing.csv")
    return pd.read_csv(csv_path)
```

This function returns a Pandas DataFrame object containing all the data.

Take a Quick Look at the Data Structure

Let's take a look at the top five rows using the DataFrame's `head()` method (see [Figure 2-5](#)).

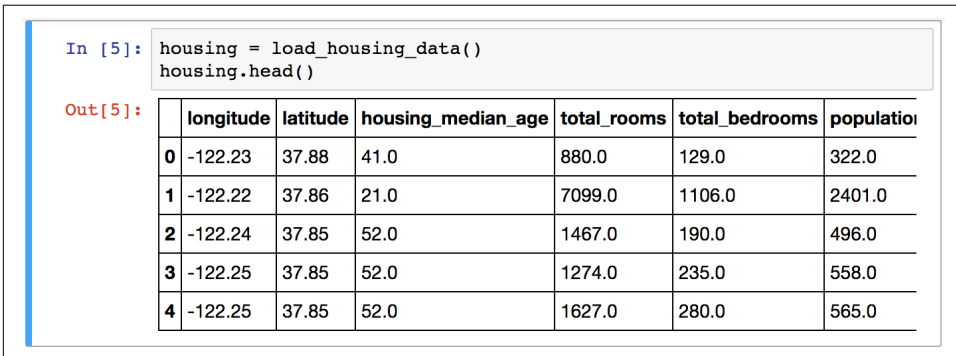

The screenshot shows a Jupyter Notebook cell with the following code and output:

```
In [5]: housing = load_housing_data()
housing.head()
```

Out[5]:

	longitude	latitude	housing_median_age	total_rooms	total_bedrooms	population
0	-122.23	37.88	41.0	880.0	129.0	322.0
1	-122.22	37.86	21.0	7099.0	1106.0	2401.0
2	-122.24	37.85	52.0	1467.0	190.0	496.0
3	-122.25	37.85	52.0	1274.0	235.0	558.0
4	-122.25	37.85	52.0	1627.0	280.0	565.0

Figure 2-5. Top five rows in the dataset

Each row represents one district. There are 10 attributes (you can see the first 6 in the screenshot): `longitude`, `latitude`, `housing_median_age`, `total_rooms`, `total_bedrooms`, `population`, `households`, `median_income`, `median_house_value`, and `ocean_proximity`.

The `info()` method is useful to get a quick description of the data, in particular the total number of rows, and each attribute's type and number of non-null values (see [Figure 2-6](#)).

```
In [6]: housing.info()

<class 'pandas.core.frame.DataFrame'>
RangeIndex: 20640 entries, 0 to 20639
Data columns (total 10 columns):
longitude                20640 non-null float64
latitude                 20640 non-null float64
housing_median_age       20640 non-null float64
total_rooms              20640 non-null float64
total_bedrooms           20433 non-null float64
population               20640 non-null float64
households               20640 non-null float64
median_income            20640 non-null float64
median_house_value       20640 non-null float64
ocean_proximity          20640 non-null object
dtypes: float64(9), object(1)
memory usage: 1.6+ MB
```

Figure 2-6. Housing info

There are 20,640 instances in the dataset, which means that it is fairly small by Machine Learning standards, but it's perfect to get started. Notice that the `total_rooms` attribute has only 20,433 non-null values, meaning that 207 districts are missing this feature. We will need to take care of this later.

All attributes are numerical, except the `ocean_proximity` field. Its type is `object`, so it could hold any kind of Python object, but since you loaded this data from a CSV file you know that it must be a text attribute. When you looked at the top five rows, you probably noticed that the values in the `ocean_proximity` column were repetitive, which means that it is probably a categorical attribute. You can find out what categories exist and how many districts belong to each category by using the `value_counts()` method:

```
>>> housing["ocean_proximity"].value_counts()
<1H OCEAN      9136
INLAND         6551
NEAR OCEAN     2658
NEAR BAY       2290
ISLAND          5
Name: ocean_proximity, dtype: int64
```

Let's look at the other fields. The `describe()` method shows a summary of the numerical attributes (Figure 2-7).

```
In [8]: housing.describe()
```

	longitude	latitude	housing_median_age	total_rooms	total_bedrooms
count	20640.000000	20640.000000	20640.000000	20640.000000	20433.000000
mean	-119.569704	35.631861	28.639486	2635.763081	537.870553
std	2.003532	2.135952	12.585558	2181.615252	421.385070
min	-124.350000	32.540000	1.000000	2.000000	1.000000
25%	-121.800000	33.930000	18.000000	1447.750000	296.000000
50%	-118.490000	34.260000	29.000000	2127.000000	435.000000
75%	-118.010000	37.710000	37.000000	3148.000000	647.000000
max	-114.310000	41.950000	52.000000	39320.000000	6445.000000

Figure 2-7. Summary of each numerical attribute

The count, mean, min, and max rows are self-explanatory. Note that the null values are ignored (so, for example, count of total_bedrooms is 20,433, not 20,640). The std row shows the *standard deviation*, which measures how dispersed the values are.¹² The 25%, 50%, and 75% rows show the corresponding *percentiles*: a percentile indicates the value below which a given percentage of observations in a group of observations falls. For example, 25% of the districts have a housing_median_age lower than 18, while 50% are lower than 29 and 75% are lower than 37. These are often called the 25th percentile (or 1st *quartile*), the median, and the 75th percentile (or 3rd *quartile*).

Another quick way to get a feel of the type of data you are dealing with is to plot a histogram for each numerical attribute. A histogram shows the number of instances (on the vertical axis) that have a given value range (on the horizontal axis). You can either plot this one attribute at a time, or you can call the hist() method on the whole dataset, and it will plot a histogram for each numerical attribute (see Figure 2-8). For example, you can see that slightly over 800 districts have a median_house_value equal to about \$100,000.

```
%matplotlib inline # only in a Jupyter notebook
import matplotlib.pyplot as plt
housing.hist(bins=50, figsize=(20,15))
plt.show()
```

¹² The standard deviation is generally denoted σ (the Greek letter sigma), and it is the square root of the *variance*, which is the average of the squared deviation from the mean. When a feature has a bell-shaped *normal distribution* (also called a *Gaussian distribution*), which is very common, the “68-95-99.7” rule applies: about 68% of the values fall within 1σ of the mean, 95% within 2σ , and 99.7% within 3σ .



The `hist()` method relies on Matplotlib, which in turn relies on a user-specified graphical backend to draw on your screen. So before you can plot anything, you need to specify which backend Matplotlib should use. The simplest option is to use Jupyter's magic command `%matplotlib inline`. This tells Jupyter to set up Matplotlib so it uses Jupyter's own backend. Plots are then rendered within the notebook itself. Note that calling `show()` is optional in a Jupyter notebook, as Jupyter will automatically display plots when a cell is executed.

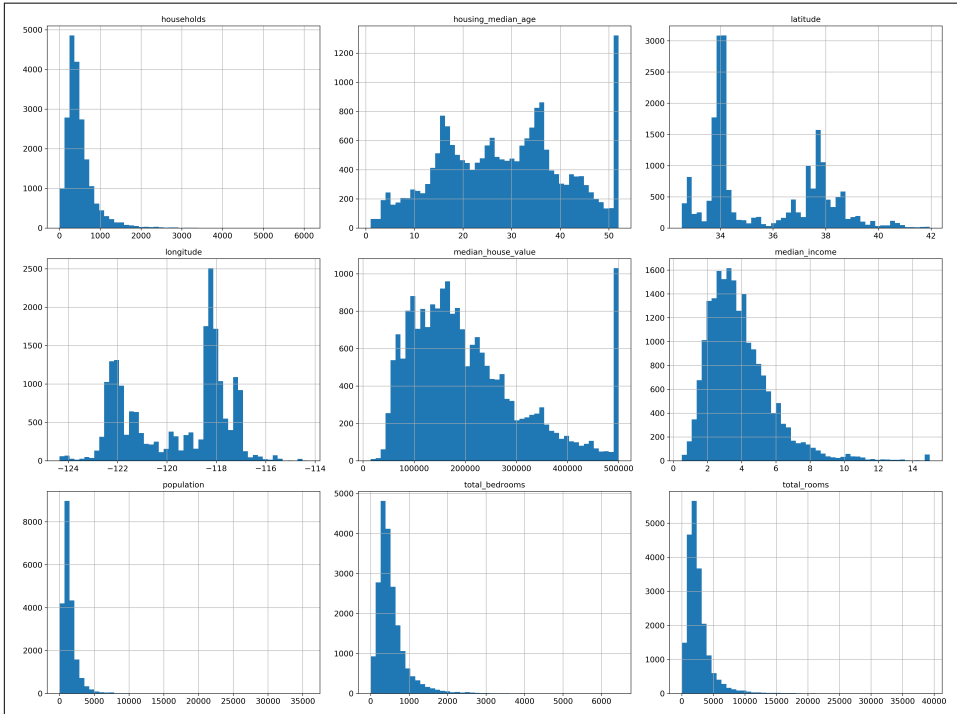

Figure 2-8. A histogram for each numerical attribute

Notice a few things in these histograms:

1. First, the median income attribute does not look like it is expressed in US dollars (USD). After checking with the team that collected the data, you are told that the data has been scaled and capped at 15 (actually 15.0001) for higher median incomes, and at 0.5 (actually 0.4999) for lower median incomes. The numbers represent roughly tens of thousands of dollars (e.g., 3 actually means about \$30,000). Working with preprocessed attributes is common in Machine Learning,

and it is not necessarily a problem, but you should try to understand how the data was computed.

2. The housing median age and the median house value were also capped. The latter may be a serious problem since it is your target attribute (your labels). Your Machine Learning algorithms may learn that prices never go beyond that limit. You need to check with your client team (the team that will use your system's output) to see if this is a problem or not. If they tell you that they need precise predictions even beyond \$500,000, then you have mainly two options:
 - a. Collect proper labels for the districts whose labels were capped.
 - b. Remove those districts from the training set (and also from the test set, since your system should not be evaluated poorly if it predicts values beyond \$500,000).
3. These attributes have very different scales. We will discuss this later in this chapter when we explore feature scaling.
4. Finally, many histograms are *tail heavy*: they extend much farther to the right of the median than to the left. This may make it a bit harder for some Machine Learning algorithms to detect patterns. We will try transforming these attributes later on to have more bell-shaped distributions.

Hopefully you now have a better understanding of the kind of data you are dealing with.



Wait! Before you look at the data any further, you need to create a test set, put it aside, and never look at it.

Create a Test Set

It may sound strange to voluntarily set aside part of the data at this stage. After all, you have only taken a quick glance at the data, and surely you should learn a whole lot more about it before you decide what algorithms to use, right? This is true, but your brain is an amazing pattern detection system, which means that it is highly prone to overfitting: if you look at the test set, you may stumble upon some seemingly interesting pattern in the test data that leads you to select a particular kind of Machine Learning model. When you estimate the generalization error using the test set, your estimate will be too optimistic and you will launch a system that will not perform as well as expected. This is called *data snooping* bias.

Creating a test set is theoretically quite simple: just pick some instances randomly, typically 20% of the dataset (or less if your dataset is very large), and set them aside:

```
import numpy as np

def split_train_test(data, test_ratio):
    shuffled_indices = np.random.permutation(len(data))
    test_set_size = int(len(data) * test_ratio)
    test_indices = shuffled_indices[:test_set_size]
    train_indices = shuffled_indices[test_set_size:]
    return data.iloc[train_indices], data.iloc[test_indices]
```

You can then use this function like this:¹³

```
>>> train_set, test_set = split_train_test(housing, 0.2)
>>> len(train_set)
16512
>>> len(test_set)
4128
```

Well, this works, but it is not perfect: if you run the program again, it will generate a different test set! Over time, you (or your Machine Learning algorithms) will get to see the whole dataset, which is what you want to avoid.

One solution is to save the test set on the first run and then load it in subsequent runs. Another option is to set the random number generator's seed (e.g., `np.random.seed(42)`)¹⁴ before calling `np.random.permutation()`, so that it always generates the same shuffled indices.

But both these solutions will break next time you fetch an updated dataset. A common solution is to use each instance's identifier to decide whether or not it should go in the test set (assuming instances have a unique and immutable identifier). For example, you could compute a hash of each instance's identifier and put that instance in the test set if the hash is lower or equal to 20% of the maximum hash value. This ensures that the test set will remain consistent across multiple runs, even if you refresh the dataset. The new test set will contain 20% of the new instances, but it will not contain any instance that was previously in the training set. Here is a possible implementation:

```
from zlib import crc32

def test_set_check(identifier, test_ratio):
    return crc32(np.int64(identifier)) & 0xffffffff < test_ratio * 2**32

def split_train_test_by_id(data, test_ratio, id_column):
    ids = data[id_column]
```

¹³ In this book, when a code example contains a mix of code and outputs, as is the case here, it is formatted like in the Python interpreter, for better readability: the code lines are prefixed with `>>>` (or `...` for indented blocks), and the outputs have no prefix.

¹⁴ You will often see people set the random seed to 42. This number has no special property, other than to be *The Answer to the Ultimate Question of Life, the Universe, and Everything*.

```
in_test_set = ids.apply(lambda id_: test_set_check(id_, test_ratio))
return data.loc[~in_test_set], data.loc[in_test_set]
```

Unfortunately, the housing dataset does not have an identifier column. The simplest solution is to use the row index as the ID:

```
housing_with_id = housing.reset_index() # adds an `index` column
train_set, test_set = split_train_test_by_id(housing_with_id, 0.2, "index")
```

If you use the row index as a unique identifier, you need to make sure that new data gets appended to the end of the dataset, and no row ever gets deleted. If this is not possible, then you can try to use the most stable features to build a unique identifier. For example, a district's latitude and longitude are guaranteed to be stable for a few million years, so you could combine them into an ID like so:¹⁵

```
housing_with_id["id"] = housing["longitude"] * 1000 + housing["latitude"]
train_set, test_set = split_train_test_by_id(housing_with_id, 0.2, "id")
```

Scikit-Learn provides a few functions to split datasets into multiple subsets in various ways. The simplest function is `train_test_split`, which does pretty much the same thing as the function `split_train_test` defined earlier, with a couple of additional features. First there is a `random_state` parameter that allows you to set the random generator seed as explained previously, and second you can pass it multiple datasets with an identical number of rows, and it will split them on the same indices (this is very useful, for example, if you have a separate DataFrame for labels):

```
from sklearn.model_selection import train_test_split

train_set, test_set = train_test_split(housing, test_size=0.2, random_state=42)
```

So far we have considered purely random sampling methods. This is generally fine if your dataset is large enough (especially relative to the number of attributes), but if it is not, you run the risk of introducing a significant sampling bias. When a survey company decides to call 1,000 people to ask them a few questions, they don't just pick 1,000 people randomly in a phone book. They try to ensure that these 1,000 people are representative of the whole population. For example, the US population is composed of 51.3% female and 48.7% male, so a well-conducted survey in the US would try to maintain this ratio in the sample: 513 female and 487 male. This is called *stratified sampling*: the population is divided into homogeneous subgroups called *strata*, and the right number of instances is sampled from each stratum to guarantee that the test set is representative of the overall population. If they used purely random sampling, there would be about 12% chance of sampling a skewed test set with either less than 49% female or more than 54% female. Either way, the survey results would be significantly biased.

¹⁵ The location information is actually quite coarse, and as a result many districts will have the exact same ID, so they will end up in the same set (test or train). This introduces some unfortunate sampling bias.

Suppose you chatted with experts who told you that the median income is a very important attribute to predict median housing prices. You may want to ensure that the test set is representative of the various categories of incomes in the whole dataset. Since the median income is a continuous numerical attribute, you first need to create an income category attribute. Let's look at the median income histogram more closely (back in [Figure 2-8](#)): most median income values are clustered around 1.5 to 6 (i.e., \$15,000–\$60,000), but some median incomes go far beyond 6. It is important to have a sufficient number of instances in your dataset for each stratum, or else the estimate of the stratum's importance may be biased. This means that you should not have too many strata, and each stratum should be large enough. The following code uses the `pd.cut()` function to create an income category attribute with 5 categories (labeled from 1 to 5): category 1 ranges from 0 to 1.5 (i.e., less than \$15,000), category 2 from 1.5 to 3, and so on:

```
housing["income_cat"] = pd.cut(housing["median_income"],
                               bins=[0., 1.5, 3.0, 4.5, 6., np.inf],
                               labels=[1, 2, 3, 4, 5])
```

These income categories are represented in [Figure 2-9](#):

```
housing["income_cat"].hist()
```

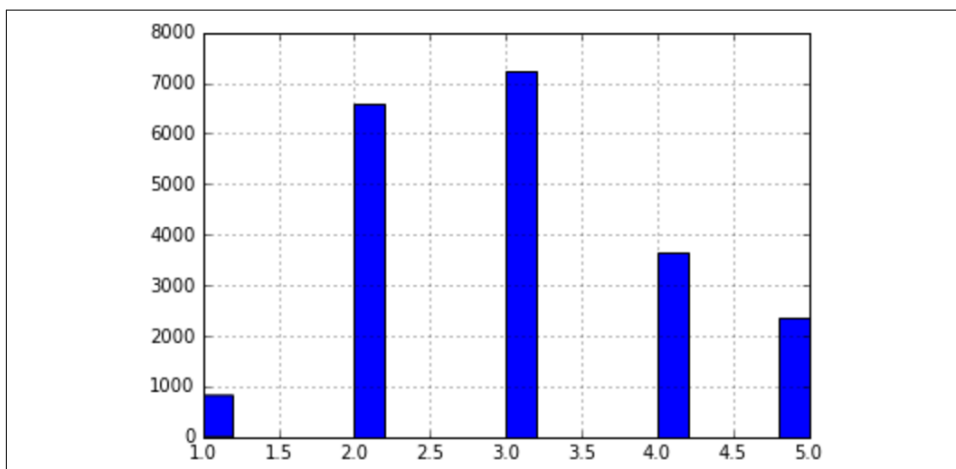

Figure 2-9. Histogram of income categories

Now you are ready to do stratified sampling based on the income category. For this you can use Scikit-Learn's `StratifiedShuffleSplit` class:

```
from sklearn.model_selection import StratifiedShuffleSplit

split = StratifiedShuffleSplit(n_splits=1, test_size=0.2, random_state=42)
for train_index, test_index in split.split(housing, housing["income_cat"]):
    strat_train_set = housing.loc[train_index]
    strat_test_set = housing.loc[test_index]
```

Let's see if this worked as expected. You can start by looking at the income category proportions in the test set:

```
>>> strat_test_set["income_cat"].value_counts() / len(strat_test_set)
3    0.350533
2    0.318798
4    0.176357
5    0.114583
1    0.039729
Name: income_cat, dtype: float64
```

With similar code you can measure the income category proportions in the full dataset. [Figure 2-10](#) compares the income category proportions in the overall dataset, in the test set generated with stratified sampling, and in a test set generated using purely random sampling. As you can see, the test set generated using stratified sampling has income category proportions almost identical to those in the full dataset, whereas the test set generated using purely random sampling is quite skewed.

	Overall	Random	Stratified	Rand. %error	Strat. %error
1.0	0.039826	0.040213	0.039738	0.973236	-0.219137
2.0	0.318847	0.324370	0.318876	1.732260	0.009032
3.0	0.350581	0.358527	0.350618	2.266446	0.010408
4.0	0.176308	0.167393	0.176399	-5.056334	0.051717
5.0	0.114438	0.109496	0.114369	-4.318374	-0.060464

Figure 2-10. Sampling bias comparison of stratified versus purely random sampling

Now you should remove the `income_cat` attribute so the data is back to its original state:

```
for set_ in (strat_train_set, strat_test_set):
    set_.drop("income_cat", axis=1, inplace=True)
```

We spent quite a bit of time on test set generation for a good reason: this is an often neglected but critical part of a Machine Learning project. Moreover, many of these ideas will be useful later when we discuss cross-validation. Now it's time to move on to the next stage: exploring the data.

Discover and Visualize the Data to Gain Insights

So far you have only taken a quick glance at the data to get a general understanding of the kind of data you are manipulating. Now the goal is to go a little bit more in depth.

First, make sure you have put the test set aside and you are only exploring the training set. Also, if the training set is very large, you may want to sample an exploration

set, to make manipulations easy and fast. In our case, the set is quite small so you can just work directly on the full set. Let's create a copy so you can play with it without harming the training set:

```
housing = strat_train_set.copy()
```

Visualizing Geographical Data

Since there is geographical information (latitude and longitude), it is a good idea to create a scatterplot of all districts to visualize the data (Figure 2-11):

```
housing.plot(kind="scatter", x="longitude", y="latitude")
```

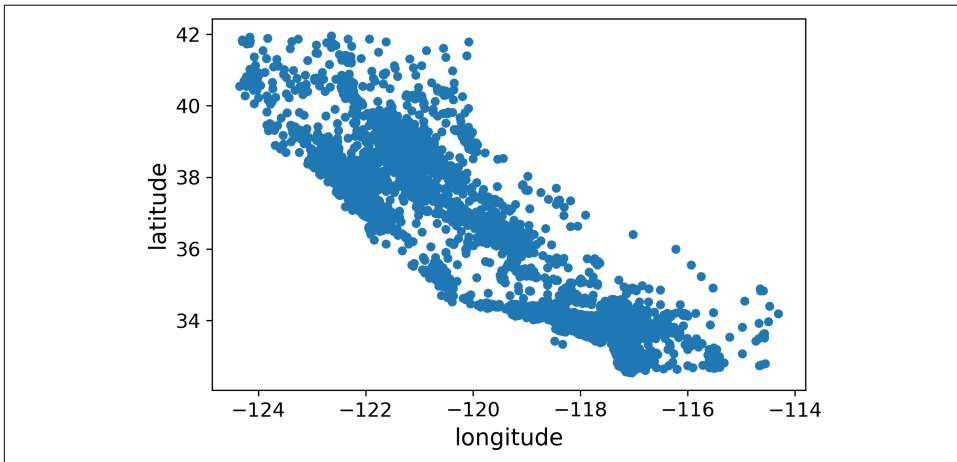

Figure 2-11. A geographical scatterplot of the data

This looks like California all right, but other than that it is hard to see any particular pattern. Setting the `alpha` option to `0.1` makes it much easier to visualize the places where there is a high density of data points (Figure 2-12):

```
housing.plot(kind="scatter", x="longitude", y="latitude", alpha=0.1)
```

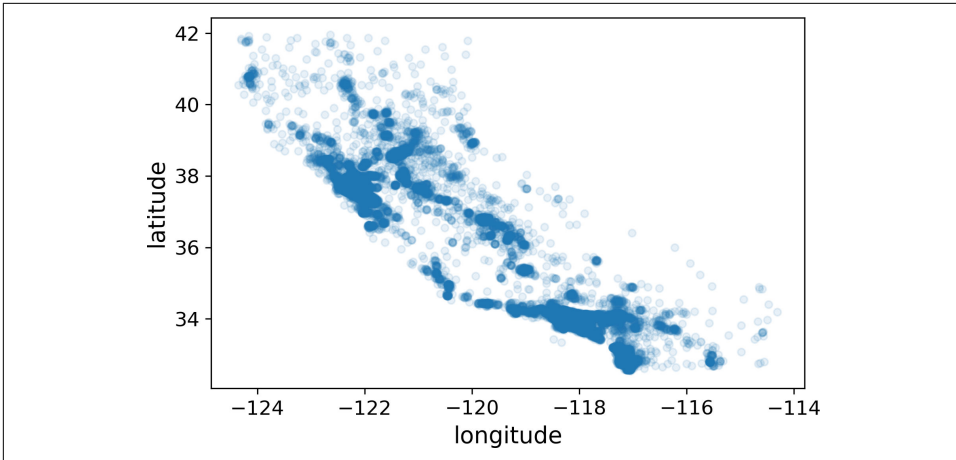

Figure 2-12. A better visualization highlighting high-density areas

Now that's much better: you can clearly see the high-density areas, namely the Bay Area and around Los Angeles and San Diego, plus a long line of fairly high density in the Central Valley, in particular around Sacramento and Fresno.

More generally, our brains are very good at spotting patterns on pictures, but you may need to play around with visualization parameters to make the patterns stand out.

Now let's look at the housing prices (Figure 2-13). The radius of each circle represents the district's population (option `s`), and the color represents the price (option `c`). We will use a predefined color map (option `cmap`) called `jet`, which ranges from blue (low values) to red (high prices):¹⁶

```
housing.plot(kind="scatter", x="longitude", y="latitude", alpha=0.4,
             s=housing["population"]/100, label="population", figsize=(10,7),
             c="median_house_value", cmap=plt.get_cmap("jet"), colorbar=True,
             )
plt.legend()
```

¹⁶ If you are reading this in grayscale, grab a red pen and scribble over most of the coastline from the Bay Area down to San Diego (as you might expect). You can add a patch of yellow around Sacramento as well.

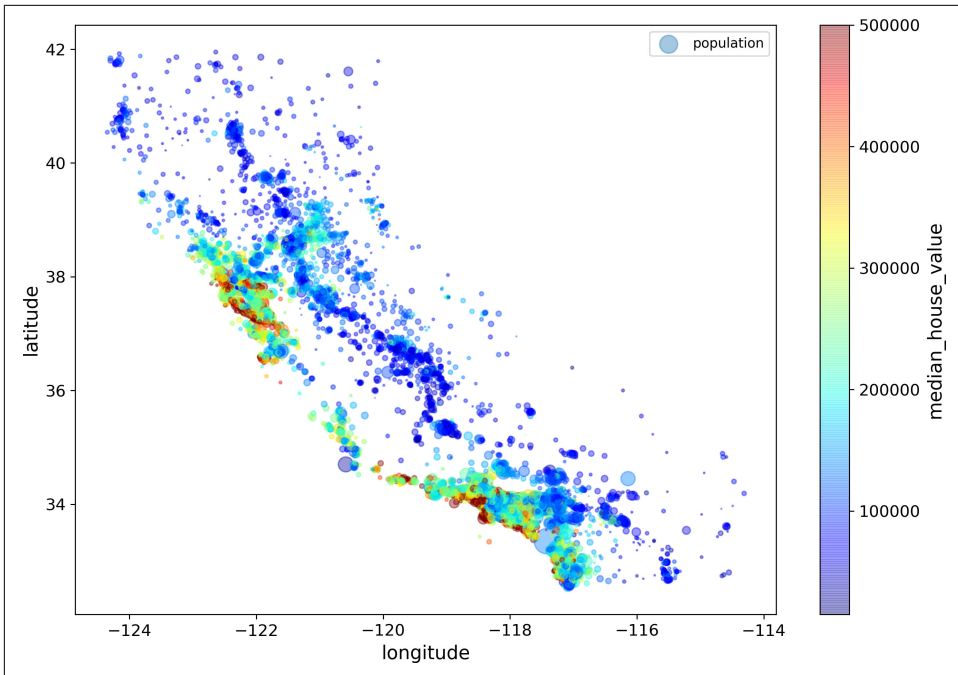

Figure 2-13. California housing prices

This image tells you that the housing prices are very much related to the location (e.g., close to the ocean) and to the population density, as you probably knew already. It will probably be useful to use a clustering algorithm to detect the main clusters, and add new features that measure the proximity to the cluster centers. The ocean proximity attribute may be useful as well, although in Northern California the housing prices in coastal districts are not too high, so it is not a simple rule.

Looking for Correlations

Since the dataset is not too large, you can easily compute the *standard correlation coefficient* (also called *Pearson's r*) between every pair of attributes using the `corr()` method:

```
corr_matrix = housing.corr()
```

Now let's look at how much each attribute correlates with the median house value:

```
>>> corr_matrix["median_house_value"].sort_values(ascending=False)
median_house_value    1.000000
median_income         0.687170
total_rooms           0.135231
housing_median_age    0.114220
households            0.064702
total_bedrooms        0.047865
population            -0.026699
longitude             -0.047279
latitude              -0.142826
Name: median_house_value, dtype: float64
```

The correlation coefficient ranges from -1 to 1 . When it is close to 1 , it means that there is a strong positive correlation; for example, the median house value tends to go up when the median income goes up. When the coefficient is close to -1 , it means that there is a strong negative correlation; you can see a small negative correlation between the latitude and the median house value (i.e., prices have a slight tendency to go down when you go north). Finally, coefficients close to zero mean that there is no linear correlation. [Figure 2-14](#) shows various plots along with the correlation coefficient between their horizontal and vertical axes.

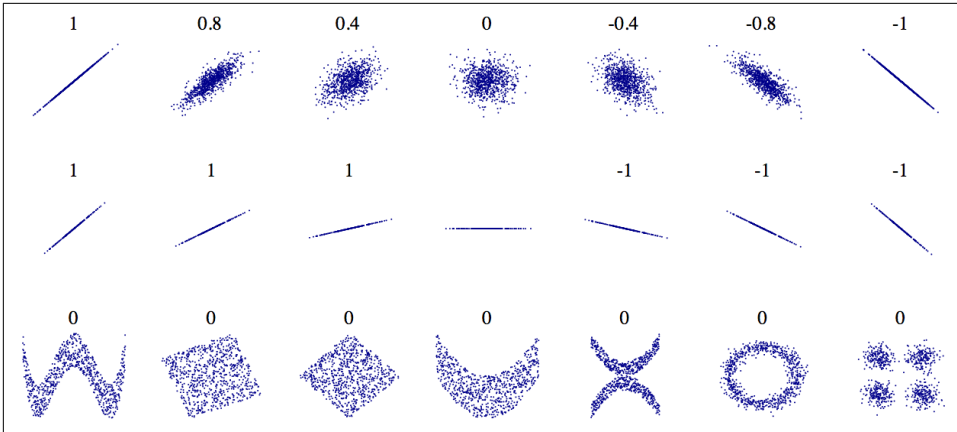

Figure 2-14. Standard correlation coefficient of various datasets (source: Wikipedia; public domain image)



The correlation coefficient only measures linear correlations (“if x goes up, then y generally goes up/down”). It may completely miss out on nonlinear relationships (e.g., “if x is close to zero then y generally goes up”). Note how all the plots of the bottom row have a correlation coefficient equal to zero despite the fact that their axes are clearly not independent: these are examples of nonlinear relationships. Also, the second row shows examples where the correlation coefficient is equal to 1 or -1 ; notice that this has nothing to do with the slope. For example, your height in inches has a correlation coefficient of 1 with your height in feet or in nanometers.

Another way to check for correlation between attributes is to use Pandas’ `scatter_matrix` function, which plots every numerical attribute against every other numerical attribute. Since there are now 11 numerical attributes, you would get $11^2 = 121$ plots, which would not fit on a page, so let’s just focus on a few promising attributes that seem most correlated with the median housing value (Figure 2-15):

```
from pandas.plotting import scatter_matrix

attributes = ["median_house_value", "median_income", "total_rooms",
             "housing_median_age"]
scatter_matrix(housing[attributes], figsize=(12, 8))
```

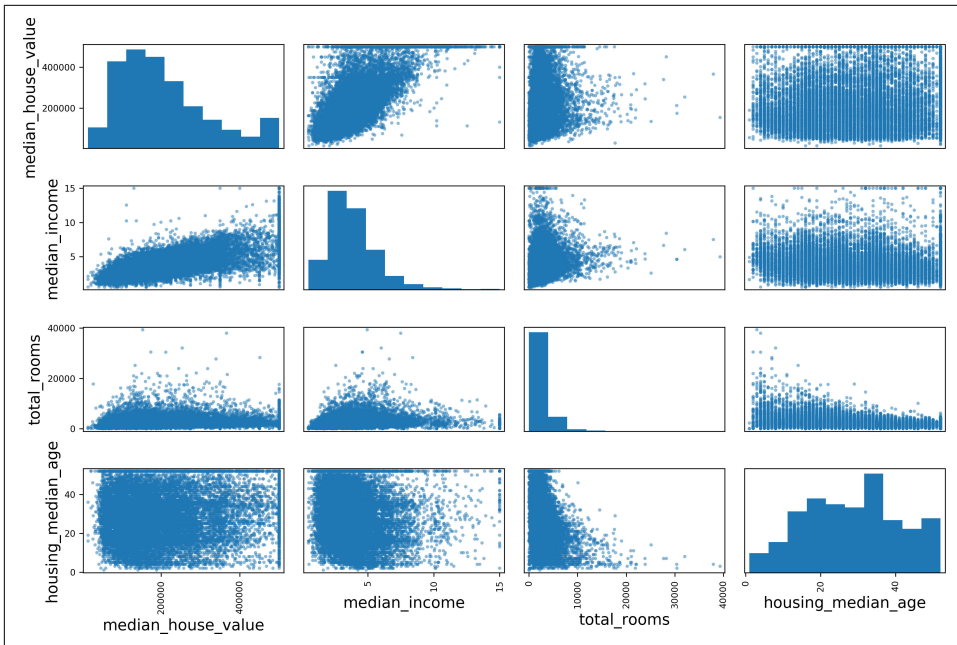

Figure 2-15. Scatter matrix

The main diagonal (top left to bottom right) would be full of straight lines if Pandas plotted each variable against itself, which would not be very useful. So instead Pandas displays a histogram of each attribute (other options are available; see Pandas' documentation for more details).

The most promising attribute to predict the median house value is the median income, so let's zoom in on their correlation scatterplot (Figure 2-16):

```
housing.plot(kind="scatter", x="median_income", y="median_house_value",
             alpha=0.1)
```

This plot reveals a few things. First, the correlation is indeed very strong; you can clearly see the upward trend and the points are not too dispersed. Second, the price cap that we noticed earlier is clearly visible as a horizontal line at \$500,000. But this plot reveals other less obvious straight lines: a horizontal line around \$450,000, another around \$350,000, perhaps one around \$280,000, and a few more below that. You may want to try removing the corresponding districts to prevent your algorithms from learning to reproduce these data quirks.

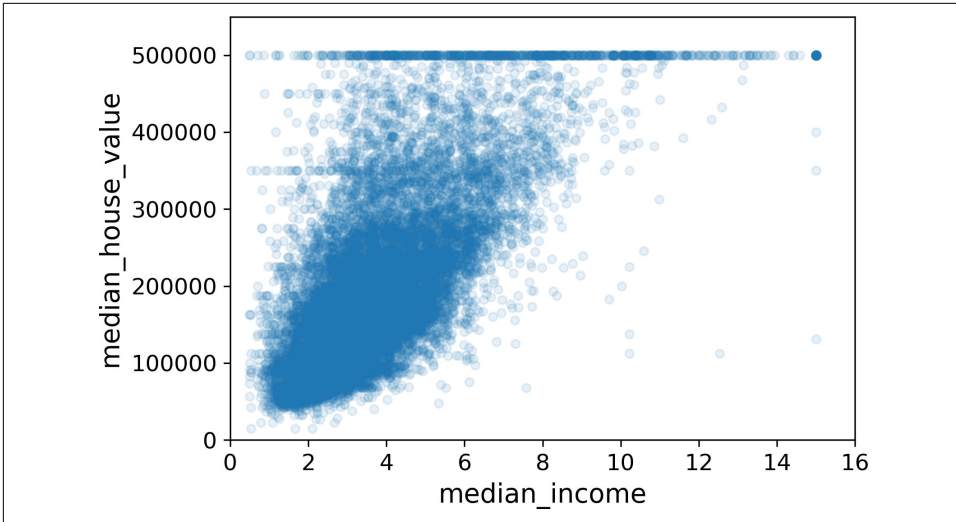

Figure 2-16. Median income versus median house value

Experimenting with Attribute Combinations

Hopefully the previous sections gave you an idea of a few ways you can explore the data and gain insights. You identified a few data quirks that you may want to clean up before feeding the data to a Machine Learning algorithm, and you found interesting correlations between attributes, in particular with the target attribute. You also noticed that some attributes have a tail-heavy distribution, so you may want to transform them (e.g., by computing their logarithm). Of course, your mileage will vary considerably with each project, but the general ideas are similar.

One last thing you may want to do before actually preparing the data for Machine Learning algorithms is to try out various attribute combinations. For example, the total number of rooms in a district is not very useful if you don't know how many households there are. What you really want is the number of rooms per household. Similarly, the total number of bedrooms by itself is not very useful: you probably want to compare it to the number of rooms. And the population per household also seems like an interesting attribute combination to look at. Let's create these new attributes:

```
housing["rooms_per_household"] = housing["total_rooms"]/housing["households"]
housing["bedrooms_per_room"] = housing["total_bedrooms"]/housing["total_rooms"]
housing["population_per_household"]=housing["population"]/housing["households"]
```

And now let's look at the correlation matrix again:

```
>>> corr_matrix = housing.corr()
>>> corr_matrix["median_house_value"].sort_values(ascending=False)
median_house_value      1.000000
```

```
median_income          0.687160
rooms_per_household    0.146285
total_rooms            0.135097
housing_median_age     0.114110
households             0.064506
total_bedrooms         0.047689
population_per_household -0.021985
population             -0.026920
longitude              -0.047432
latitude               -0.142724
bedrooms_per_room      -0.259984
Name: median_house_value, dtype: float64
```

Hey, not bad! The new `bedrooms_per_room` attribute is much more correlated with the median house value than the total number of rooms or bedrooms. Apparently houses with a lower bedroom/room ratio tend to be more expensive. The number of rooms per household is also more informative than the total number of rooms in a district—obviously the larger the houses, the more expensive they are.

This round of exploration does not have to be absolutely thorough; the point is to start off on the right foot and quickly gain insights that will help you get a first reasonably good prototype. But this is an iterative process: once you get a prototype up and running, you can analyze its output to gain more insights and come back to this exploration step.

Prepare the Data for Machine Learning Algorithms

It's time to prepare the data for your Machine Learning algorithms. Instead of just doing this manually, you should write functions to do that, for several good reasons:

- This will allow you to reproduce these transformations easily on any dataset (e.g., the next time you get a fresh dataset).
- You will gradually build a library of transformation functions that you can reuse in future projects.
- You can use these functions in your live system to transform the new data before feeding it to your algorithms.
- This will make it possible for you to easily try various transformations and see which combination of transformations works best.

But first let's revert to a clean training set (by copying `strat_train_set` once again), and let's separate the predictors and the labels since we don't necessarily want to apply the same transformations to the predictors and the target values (note that `drop()` creates a copy of the data and does not affect `strat_train_set`):

```
housing = strat_train_set.drop("median_house_value", axis=1)
housing_labels = strat_train_set["median_house_value"].copy()
```

Data Cleaning

Most Machine Learning algorithms cannot work with missing features, so let's create a few functions to take care of them. You noticed earlier that the `total_bedrooms` attribute has some missing values, so let's fix this. You have three options:

- Get rid of the corresponding districts.
- Get rid of the whole attribute.
- Set the values to some value (zero, the mean, the median, etc.).

You can accomplish these easily using `DataFrame`'s `dropna()`, `drop()`, and `fillna()` methods:

```
housing.dropna(subset=["total_bedrooms"]) # option 1
housing.drop("total_bedrooms", axis=1)    # option 2
median = housing["total_bedrooms"].median() # option 3
housing["total_bedrooms"].fillna(median, inplace=True)
```

If you choose option 3, you should compute the median value on the training set, and use it to fill the missing values in the training set, but also don't forget to save the median value that you have computed. You will need it later to replace missing values in the test set when you want to evaluate your system, and also once the system goes live to replace missing values in new data.

Scikit-Learn provides a handy class to take care of missing values: `SimpleImputer`. Here is how to use it. First, you need to create a `SimpleImputer` instance, specifying that you want to replace each attribute's missing values with the median of that attribute:

```
from sklearn.impute import SimpleImputer

imputer = SimpleImputer(strategy="median")
```

Since the median can only be computed on numerical attributes, we need to create a copy of the data without the text attribute `ocean_proximity`:

```
housing_num = housing.drop("ocean_proximity", axis=1)
```

Now you can fit the `imputer` instance to the training data using the `fit()` method:

```
imputer.fit(housing_num)
```

The `imputer` has simply computed the median of each attribute and stored the result in its `statistics_` instance variable. Only the `total_bedrooms` attribute had missing values, but we cannot be sure that there won't be any missing values in new data after the system goes live, so it is safer to apply the `imputer` to all the numerical attributes:

```
>>> imputer.statistics_
array([-118.51 , 34.26 , 29. , 2119.5 , 433. , 1164. , 408. , 3.5409])
```

```
>>> housing_num.median().values
array([ -118.51 ,  34.26 ,  29. , 2119.5 ,  433. , 1164. ,  408. ,  3.5409])
```

Now you can use this “trained” imputer to transform the training set by replacing missing values by the learned medians:

```
X = imputer.transform(housing_num)
```

The result is a plain NumPy array containing the transformed features. If you want to put it back into a Pandas DataFrame, it’s simple:

```
housing_tr = pd.DataFrame(X, columns=housing_num.columns)
```

Scikit-Learn Design

Scikit-Learn’s API is remarkably well designed. The **main design principles** are:¹⁷

- **Consistency.** All objects share a consistent and simple interface:
 - *Estimators.* Any object that can estimate some parameters based on a dataset is called an *estimator* (e.g., an `imputer` is an estimator). The estimation itself is performed by the `fit()` method, and it takes only a dataset as a parameter (or two for supervised learning algorithms; the second dataset contains the labels). Any other parameter needed to guide the estimation process is considered a hyperparameter (such as an `imputer`’s `strategy`), and it must be set as an instance variable (generally via a constructor parameter).
 - *Transformers.* Some estimators (such as an `imputer`) can also transform a dataset; these are called *transformers*. Once again, the API is quite simple: the transformation is performed by the `transform()` method with the dataset to transform as a parameter. It returns the transformed dataset. This transformation generally relies on the learned parameters, as is the case for an `imputer`. All transformers also have a convenience method called `fit_transform()` that is equivalent to calling `fit()` and then `transform()` (but sometimes `fit_transform()` is optimized and runs much faster).
 - *Predictors.* Finally, some estimators are capable of making predictions given a dataset; they are called *predictors*. For example, the `LinearRegression` model in the previous chapter was a predictor: it predicted life satisfaction given a country’s GDP per capita. A predictor has a `predict()` method that takes a dataset of new instances and returns a dataset of corresponding predictions. It also has a `score()` method that measures the quality of the predictions given

¹⁷ For more details on the design principles, see “API design for machine learning software: experiences from the scikit-learn project,” L. Buitinck, G. Louppe, M. Blondel, F. Pedregosa, A. Müller, et al. (2013).

a test set (and the corresponding labels in the case of supervised learning algorithms).¹⁸

- **Inspection.** All the estimator's hyperparameters are accessible directly via public instance variables (e.g., `imputer.strategy`), and all the estimator's learned parameters are also accessible via public instance variables with an underscore suffix (e.g., `imputer.statistics_`).
- **Nonproliferation of classes.** Datasets are represented as NumPy arrays or SciPy sparse matrices, instead of homemade classes. Hyperparameters are just regular Python strings or numbers.
- **Composition.** Existing building blocks are reused as much as possible. For example, it is easy to create a `Pipeline` estimator from an arbitrary sequence of transformers followed by a final estimator, as we will see.
- **Sensible defaults.** Scikit-Learn provides reasonable default values for most parameters, making it easy to create a baseline working system quickly.

Handling Text and Categorical Attributes

Earlier we left out the categorical attribute `ocean_proximity` because it is a text attribute so we cannot compute its median:

```
>>> housing_cat = housing[["ocean_proximity"]]
>>> housing_cat.head(10)
   ocean_proximity
17606      <1H OCEAN
18632      <1H OCEAN
14650      NEAR OCEAN
3230         INLAND
3555      <1H OCEAN
19480         INLAND
8879      <1H OCEAN
13685         INLAND
4937      <1H OCEAN
4861      <1H OCEAN
```

Most Machine Learning algorithms prefer to work with numbers anyway, so let's convert these categories from text to numbers. For this, we can use Scikit-Learn's `OrdinalEncoder` class¹⁹:

```
>>> from sklearn.preprocessing import OrdinalEncoder
>>> ordinal_encoder = OrdinalEncoder()
```

¹⁸ Some predictors also provide methods to measure the confidence of their predictions.

¹⁹ This class is available since Scikit-Learn 0.20. If you use an earlier version, please consider upgrading, or use Pandas' `Series.factorize()` method.

```

>>> housing_cat_encoded = ordinal_encoder.fit_transform(housing_cat)
>>> housing_cat_encoded[:10]
array([[0.],
       [0.],
       [4.],
       [1.],
       [0.],
       [1.],
       [0.],
       [1.],
       [0.],
       [0.]])

```

You can get the list of categories using the `categories_` instance variable. It is a list containing a 1D array of categories for each categorical attribute (in this case, a list containing a single array since there is just one categorical attribute):

```

>>> ordinal_encoder.categories_
[array(['<1H OCEAN', 'INLAND', 'ISLAND', 'NEAR BAY', 'NEAR OCEAN'],
      dtype=object)]

```

One issue with this representation is that ML algorithms will assume that two nearby values are more similar than two distant values. This may be fine in some cases (e.g., for ordered categories such as “bad”, “average”, “good”, “excellent”), but it is obviously not the case for the `ocean_proximity` column (for example, categories 0 and 4 are clearly more similar than categories 0 and 1). To fix this issue, a common solution is to create one binary attribute per category: one attribute equal to 1 when the category is “<1H OCEAN” (and 0 otherwise), another attribute equal to 1 when the category is “INLAND” (and 0 otherwise), and so on. This is called *one-hot encoding*, because only one attribute will be equal to 1 (hot), while the others will be 0 (cold). The new attributes are sometimes called *dummy* attributes. Scikit-Learn provides a `OneHotEncoder` class to convert categorical values into one-hot vectors²⁰:

```

>>> from sklearn.preprocessing import OneHotEncoder
>>> cat_encoder = OneHotEncoder()
>>> housing_cat_1hot = cat_encoder.fit_transform(housing_cat)
>>> housing_cat_1hot
<16512x5 sparse matrix of type '<class 'numpy.float64'>'
  with 16512 stored elements in Compressed Sparse Row format>

```

Notice that the output is a SciPy *sparse matrix*, instead of a NumPy array. This is very useful when you have categorical attributes with thousands of categories. After one-hot encoding we get a matrix with thousands of columns, and the matrix is full of zeros except for a single 1 per row. Using up tons of memory mostly to store zeros would be very wasteful, so instead a sparse matrix only stores the location of the non-

²⁰ Before Scikit-Learn 0.20, it could only encode integer categorical values, but since 0.20 it can also handle other types of inputs, including text categorical inputs.

zero elements. You can use it mostly like a normal 2D array,²¹ but if you really want to convert it to a (dense) NumPy array, just call the `toarray()` method:

```
>>> housing_cat_1hot.toarray()
array([[1., 0., 0., 0., 0.],
       [1., 0., 0., 0., 0.],
       [0., 0., 0., 0., 1.],
       ...,
       [0., 1., 0., 0., 0.],
       [1., 0., 0., 0., 0.],
       [0., 0., 0., 1., 0.]])
```

Once again, you can get the list of categories using the encoder's `categories_` instance variable:

```
>>> cat_encoder.categories_
[array(['<1H OCEAN', 'INLAND', 'ISLAND', 'NEAR BAY', 'NEAR OCEAN'],
      dtype=object)]
```



If a categorical attribute has a large number of possible categories (e.g., country code, profession, species, etc.), then one-hot encoding will result in a large number of input features. This may slow down training and degrade performance. If this happens, you may want to replace the categorical input with useful numerical features related to the categories: for example, you could replace the `ocean_proximity` feature with the distance to the ocean (similarly, a country code could be replaced with the country's population and GDP per capita). Alternatively, you could replace each category with a learnable low dimensional vector called an *embedding*. Each category's representation would be learned during training: this is an example of *representation learning* (see [Chapter 13](#) and [???](#) for more details).

Custom Transformers

Although Scikit-Learn provides many useful transformers, you will need to write your own for tasks such as custom cleanup operations or combining specific attributes. You will want your transformer to work seamlessly with Scikit-Learn functionalities (such as pipelines), and since Scikit-Learn relies on duck typing (not inheritance), all you need is to create a class and implement three methods: `fit()` (returning `self`), `transform()`, and `fit_transform()`. You can get the last one for free by simply adding `TransformerMixin` as a base class. Also, if you add `BaseEstimator` as a base class (and avoid `*args` and `**kwargs` in your constructor) you will get two extra methods (`get_params()` and `set_params()`) that will be useful for auto-

²¹ See SciPy's documentation for more details.

matic hyperparameter tuning. For example, here is a small transformer class that adds the combined attributes we discussed earlier:

```
from sklearn.base import BaseEstimator, TransformerMixin

rooms_ix, bedrooms_ix, population_ix, households_ix = 3, 4, 5, 6

class CombinedAttributesAdder(BaseEstimator, TransformerMixin):
    def __init__(self, add_bedrooms_per_room = True): # no *args or **kwargs
        self.add_bedrooms_per_room = add_bedrooms_per_room
    def fit(self, X, y=None):
        return self # nothing else to do
    def transform(self, X, y=None):
        rooms_per_household = X[:, rooms_ix] / X[:, households_ix]
        population_per_household = X[:, population_ix] / X[:, households_ix]
        if self.add_bedrooms_per_room:
            bedrooms_per_room = X[:, bedrooms_ix] / X[:, rooms_ix]
            return np.c_[X, rooms_per_household, population_per_household,
                          bedrooms_per_room]
        else:
            return np.c_[X, rooms_per_household, population_per_household]

attr_adder = CombinedAttributesAdder(add_bedrooms_per_room=False)
housing_extra_attribs = attr_adder.transform(housing.values)
```

In this example the transformer has one hyperparameter, `add_bedrooms_per_room`, set to `True` by default (it is often helpful to provide sensible defaults). This hyperparameter will allow you to easily find out whether adding this attribute helps the Machine Learning algorithms or not. More generally, you can add a hyperparameter to gate any data preparation step that you are not 100% sure about. The more you automate these data preparation steps, the more combinations you can automatically try out, making it much more likely that you will find a great combination (and saving you a lot of time).

Feature Scaling

One of the most important transformations you need to apply to your data is *feature scaling*. With few exceptions, Machine Learning algorithms don't perform well when the input numerical attributes have very different scales. This is the case for the housing data: the total number of rooms ranges from about 6 to 39,320, while the median incomes only range from 0 to 15. Note that scaling the target values is generally not required.

There are two common ways to get all attributes to have the same scale: *min-max scaling* and *standardization*.

Min-max scaling (many people call this *normalization*) is quite simple: values are shifted and rescaled so that they end up ranging from 0 to 1. We do this by subtracting the min value and dividing by the max minus the min. Scikit-Learn provides a

transformer called `MinMaxScaler` for this. It has a `feature_range` hyperparameter that lets you change the range if you don't want 0–1 for some reason.

Standardization is quite different: first it subtracts the mean value (so standardized values always have a zero mean), and then it divides by the standard deviation so that the resulting distribution has unit variance. Unlike min-max scaling, standardization does not bound values to a specific range, which may be a problem for some algorithms (e.g., neural networks often expect an input value ranging from 0 to 1). However, standardization is much less affected by outliers. For example, suppose a district had a median income equal to 100 (by mistake). Min-max scaling would then crush all the other values from 0–15 down to 0–0.15, whereas standardization would not be much affected. Scikit-Learn provides a transformer called `StandardScaler` for standardization.



As with all the transformations, it is important to fit the scalers to the training data only, not to the full dataset (including the test set). Only then can you use them to transform the training set and the test set (and new data).

Transformation Pipelines

As you can see, there are many data transformation steps that need to be executed in the right order. Fortunately, Scikit-Learn provides the `Pipeline` class to help with such sequences of transformations. Here is a small pipeline for the numerical attributes:

```
from sklearn.pipeline import Pipeline
from sklearn.preprocessing import StandardScaler

num_pipeline = Pipeline([
    ('imputer', SimpleImputer(strategy="median")),
    ('attribs_adder', CombinedAttributesAdder()),
    ('std_scaler', StandardScaler()),
])

housing_num_tr = num_pipeline.fit_transform(housing_num)
```

The `Pipeline` constructor takes a list of name/estimator pairs defining a sequence of steps. All but the last estimator must be transformers (i.e., they must have a `fit_transform()` method). The names can be anything you like (as long as they are unique and don't contain double underscores “`__`”): they will come in handy later for hyperparameter tuning.

When you call the pipeline's `fit()` method, it calls `fit_transform()` sequentially on all transformers, passing the output of each call as the parameter to the next call, until it reaches the final estimator, for which it just calls the `fit()` method.

The pipeline exposes the same methods as the final estimator. In this example, the last estimator is a `StandardScaler`, which is a transformer, so the pipeline has a `transform()` method that applies all the transforms to the data in sequence (and of course also a `fit_transform()` method, which is the one we used).

So far, we have handled the categorical columns and the numerical columns separately. It would be more convenient to have a single transformer able to handle all columns, applying the appropriate transformations to each column. In version 0.20, Scikit-Learn introduced the `ColumnTransformer` for this purpose, and the good news is that it works great with Pandas DataFrames. Let's use it to apply all the transformations to the housing data:

```
from sklearn.compose import ColumnTransformer

num_attribs = list(housing_num)
cat_attribs = ["ocean_proximity"]

full_pipeline = ColumnTransformer([
    ("num", num_pipeline, num_attribs),
    ("cat", OneHotEncoder(), cat_attribs),
])

housing_prepared = full_pipeline.fit_transform(housing)
```

Here is how this works: first we import the `ColumnTransformer` class, next we get the list of numerical column names and the list of categorical column names, and we construct a `ColumnTransformer`. The constructor requires a list of tuples, where each tuple contains a name²², a transformer and a list of names (or indices) of columns that the transformer should be applied to. In this example, we specify that the numerical columns should be transformed using the `num_pipeline` that we defined earlier, and the categorical columns should be transformed using a `OneHotEncoder`. Finally, we apply this `ColumnTransformer` to the housing data: it applies each transformer to the appropriate columns and concatenates the outputs along the second axis (the transformers must return the same number of rows).

Note that the `OneHotEncoder` returns a sparse matrix, while the `num_pipeline` returns a dense matrix. When there is such a mix of sparse and dense matrices, the `ColumnTransformer` estimates the density of the final matrix (i.e., the ratio of non-zero cells), and it returns a sparse matrix if the density is lower than a given threshold (by default, `sparse_threshold=0.3`). In this example, it returns a dense matrix. And that's it! We have a preprocessing pipeline that takes the full housing data and applies the appropriate transformations to each column.

²² Just like for pipelines, the name can be anything as long as it does not contain double underscores.



Instead of a transformer, you can specify the string "drop" if you want the columns to be dropped. Or you can specify "pass through" if you want the columns to be left untouched. By default, the remaining columns (i.e., the ones that were not listed) will be dropped, but you can set the remainder hyperparameter to any transformer (or to "passthrough") if you want these columns to be handled differently.

If you are using Scikit-Learn 0.19 or earlier, you can use a third-party library such as `sklearn-pandas`, or roll out your own custom transformer to get the same functionality as the `ColumnTransformer`. Alternatively, you can use the `FeatureUnion` class which can also apply different transformers and concatenate their outputs, but you cannot specify different columns for each transformer, they all apply to the whole data. It is possible to work around this limitation using a custom transformer for column selection (see the Jupyter notebook for an example).

Select and Train a Model

At last! You framed the problem, you got the data and explored it, you sampled a training set and a test set, and you wrote transformation pipelines to clean up and prepare your data for Machine Learning algorithms automatically. You are now ready to select and train a Machine Learning model.

Training and Evaluating on the Training Set

The good news is that thanks to all these previous steps, things are now going to be much simpler than you might think. Let's first train a Linear Regression model, like we did in the previous chapter:

```
from sklearn.linear_model import LinearRegression

lin_reg = LinearRegression()
lin_reg.fit(housing_prepared, housing_labels)
```

Done! You now have a working Linear Regression model. Let's try it out on a few instances from the training set:

```
>>> some_data = housing.iloc[:5]
>>> some_labels = housing_labels.iloc[:5]
>>> some_data_prepared = full_pipeline.transform(some_data)
>>> print("Predictions:", lin_reg.predict(some_data_prepared))
Predictions: [ 210644.6045  317768.8069  210956.4333  59218.9888  189747.5584]
>>> print("Labels:", list(some_labels))
Labels: [286600.0, 340600.0, 196900.0, 46300.0, 254500.0]
```

It works, although the predictions are not exactly accurate (e.g., the first prediction is off by close to 40%!). Let's measure this regression model's RMSE on the whole training set using Scikit-Learn's `mean_squared_error` function:

```
>>> from sklearn.metrics import mean_squared_error
>>> housing_predictions = lin_reg.predict(housing_prepared)
>>> lin_mse = mean_squared_error(housing_labels, housing_predictions)
>>> lin_rmse = np.sqrt(lin_mse)
>>> lin_rmse
68628.19819848922
```

Okay, this is better than nothing but clearly not a great score: most districts' `median_housing_values` range between \$120,000 and \$265,000, so a typical prediction error of \$68,628 is not very satisfying. This is an example of a model underfitting the training data. When this happens it can mean that the features do not provide enough information to make good predictions, or that the model is not powerful enough. As we saw in the previous chapter, the main ways to fix underfitting are to select a more powerful model, to feed the training algorithm with better features, or to reduce the constraints on the model. This model is not regularized, so this rules out the last option. You could try to add more features (e.g., the log of the population), but first let's try a more complex model to see how it does.

Let's train a `DecisionTreeRegressor`. This is a powerful model, capable of finding complex nonlinear relationships in the data (Decision Trees are presented in more detail in [Chapter 6](#)). The code should look familiar by now:

```
from sklearn.tree import DecisionTreeRegressor

tree_reg = DecisionTreeRegressor()
tree_reg.fit(housing_prepared, housing_labels)
```

Now that the model is trained, let's evaluate it on the training set:

```
>>> housing_predictions = tree_reg.predict(housing_prepared)
>>> tree_mse = mean_squared_error(housing_labels, housing_predictions)
>>> tree_rmse = np.sqrt(tree_mse)
>>> tree_rmse
0.0
```

Wait, what!? No error at all? Could this model really be absolutely perfect? Of course, it is much more likely that the model has badly overfit the data. How can you be sure? As we saw earlier, you don't want to touch the test set until you are ready to launch a model you are confident about, so you need to use part of the training set for training, and part for model validation.

Better Evaluation Using Cross-Validation

One way to evaluate the Decision Tree model would be to use the `train_test_split` function to split the training set into a smaller training set and a validation set, then

train your models against the smaller training set and evaluate them against the validation set. It's a bit of work, but nothing too difficult and it would work fairly well.

A great alternative is to use Scikit-Learn's *K-fold cross-validation* feature. The following code randomly splits the training set into 10 distinct subsets called *folds*, then it trains and evaluates the Decision Tree model 10 times, picking a different fold for evaluation every time and training on the other 9 folds. The result is an array containing the 10 evaluation scores:

```
from sklearn.model_selection import cross_val_score
scores = cross_val_score(tree_reg, housing_prepared, housing_labels,
                        scoring="neg_mean_squared_error", cv=10)
tree_rmse_scores = np.sqrt(-scores)
```



Scikit-Learn's cross-validation features expect a utility function (greater is better) rather than a cost function (lower is better), so the scoring function is actually the opposite of the MSE (i.e., a negative value), which is why the preceding code computes `-scores` before calculating the square root.

Let's look at the results:

```
>>> def display_scores(scores):
...     print("Scores:", scores)
...     print("Mean:", scores.mean())
...     print("Standard deviation:", scores.std())
...
>>> display_scores(tree_rmse_scores)
Scores: [70194.33680785 66855.16363941 72432.58244769 70758.73896782
 71115.88230639 75585.14172901 70262.86139133 70273.6325285
 75366.87952553 71231.65726027]
Mean: 71407.68766037929
Standard deviation: 2439.4345041191004
```

Now the Decision Tree doesn't look as good as it did earlier. In fact, it seems to perform worse than the Linear Regression model! Notice that cross-validation allows you to get not only an estimate of the performance of your model, but also a measure of how precise this estimate is (i.e., its standard deviation). The Decision Tree has a score of approximately 71,407, generally $\pm 2,439$. You would not have this information if you just used one validation set. But cross-validation comes at the cost of training the model several times, so it is not always possible.

Let's compute the same scores for the Linear Regression model just to be sure:

```
>>> lin_scores = cross_val_score(lin_reg, housing_prepared, housing_labels,
...                             scoring="neg_mean_squared_error", cv=10)
...
>>> lin_rmse_scores = np.sqrt(-lin_scores)
>>> display_scores(lin_rmse_scores)
```

```
Scores: [66782.73843989 66960.118071 70347.95244419 74739.57052552
68031.13388938 71193.84183426 64969.63056405 68281.61137997
71552.91566558 67665.10082067]
Mean: 69052.46136345083
Standard deviation: 2731.674001798348
```

That's right: the Decision Tree model is overfitting so badly that it performs worse than the Linear Regression model.

Let's try one last model now: the RandomForestRegressor. As we will see in [Chapter 7](#), Random Forests work by training many Decision Trees on random subsets of the features, then averaging out their predictions. Building a model on top of many other models is called *Ensemble Learning*, and it is often a great way to push ML algorithms even further. We will skip most of the code since it is essentially the same as for the other models:

```
>>> from sklearn.ensemble import RandomForestRegressor
>>> forest_reg = RandomForestRegressor()
>>> forest_reg.fit(housing_prepared, housing_labels)
>>> [...]
>>> forest_rmse
18603.515021376355
>>> display_scores(forest_rmse_scores)
Scores: [49519.80364233 47461.9115823 50029.02762854 52325.28068953
49308.39426421 53446.37892622 48634.8036574 47585.73832311
53490.10699751 50021.5852922 ]
Mean: 50182.303100336096
Standard deviation: 2097.0810550985693
```

Wow, this is much better: Random Forests look very promising. However, note that the score on the training set is still much lower than on the validation sets, meaning that the model is still overfitting the training set. Possible solutions for overfitting are to simplify the model, constrain it (i.e., regularize it), or get a lot more training data. However, before you dive much deeper in Random Forests, you should try out many other models from various categories of Machine Learning algorithms (several Support Vector Machines with different kernels, possibly a neural network, etc.), without spending too much time tweaking the hyperparameters. The goal is to shortlist a few (two to five) promising models.



You should save every model you experiment with, so you can come back easily to any model you want. Make sure you save both the hyperparameters and the trained parameters, as well as the cross-validation scores and perhaps the actual predictions as well. This will allow you to easily compare scores across model types, and compare the types of errors they make. You can easily save Scikit-Learn models by using Python's `pickle` module, or using `sklearn.externals.joblib`, which is more efficient at serializing large NumPy arrays:

```
from sklearn.externals import joblib

joblib.dump(my_model, "my_model.pkl")
# and later...
my_model_loaded = joblib.load("my_model.pkl")
```

Fine-Tune Your Model

Let's assume that you now have a shortlist of promising models. You now need to fine-tune them. Let's look at a few ways you can do that.

Grid Search

One way to do that would be to fiddle with the hyperparameters manually, until you find a great combination of hyperparameter values. This would be very tedious work, and you may not have time to explore many combinations.

Instead you should get Scikit-Learn's `GridSearchCV` to search for you. All you need to do is tell it which hyperparameters you want it to experiment with, and what values to try out, and it will evaluate all the possible combinations of hyperparameter values, using cross-validation. For example, the following code searches for the best combination of hyperparameter values for the `RandomForestRegressor`:

```
from sklearn.model_selection import GridSearchCV

param_grid = [
    {'n_estimators': [3, 10, 30], 'max_features': [2, 4, 6, 8]},
    {'bootstrap': [False], 'n_estimators': [3, 10], 'max_features': [2, 3, 4]},
]

forest_reg = RandomForestRegressor()

grid_search = GridSearchCV(forest_reg, param_grid, cv=5,
                           scoring='neg_mean_squared_error',
                           return_train_score=True)

grid_search.fit(housing_prepared, housing_labels)
```



When you have no idea what value a hyperparameter should have, a simple approach is to try out consecutive powers of 10 (or a smaller number if you want a more fine-grained search, as shown in this example with the `n_estimators` hyperparameter).

This `param_grid` tells Scikit-Learn to first evaluate all $3 \times 4 = 12$ combinations of `n_estimators` and `max_features` hyperparameter values specified in the first `dict` (don't worry about what these hyperparameters mean for now; they will be explained in [Chapter 7](#)), then try all $2 \times 3 = 6$ combinations of hyperparameter values in the second `dict`, but this time with the `bootstrap` hyperparameter set to `False` instead of `True` (which is the default value for this hyperparameter).

All in all, the grid search will explore $12 + 6 = 18$ combinations of `RandomForestRegressor` hyperparameter values, and it will train each model five times (since we are using five-fold cross validation). In other words, all in all, there will be $18 \times 5 = 90$ rounds of training! It may take quite a long time, but when it is done you can get the best combination of parameters like this:

```
>>> grid_search.best_params_
{'max_features': 8, 'n_estimators': 30}
```



Since 8 and 30 are the maximum values that were evaluated, you should probably try searching again with higher values, since the score may continue to improve.

You can also get the best estimator directly:

```
>>> grid_search.best_estimator_
RandomForestRegressor(bootstrap=True, criterion='mse', max_depth=None,
                       max_features=8, max_leaf_nodes=None, min_impurity_decrease=0.0,
                       min_impurity_split=None, min_samples_leaf=1,
                       min_samples_split=2, min_weight_fraction_leaf=0.0,
                       n_estimators=30, n_jobs=None, oob_score=False, random_state=None,
                       verbose=0, warm_start=False)
```



If `GridSearchCV` is initialized with `refit=True` (which is the default), then once it finds the best estimator using cross-validation, it retrains it on the whole training set. This is usually a good idea since feeding it more data will likely improve its performance.

And of course the evaluation scores are also available:

```
>>> cvres = grid_search.cv_results_
>>> for mean_score, params in zip(cvres["mean_test_score"], cvres["params"]):
```

```

...     print(np.sqrt(-mean_score), params)
...
63669.05791727153 {'max_features': 2, 'n_estimators': 3}
55627.16171305252 {'max_features': 2, 'n_estimators': 10}
53384.57867637289 {'max_features': 2, 'n_estimators': 30}
60965.99185930139 {'max_features': 4, 'n_estimators': 3}
52740.98248528835 {'max_features': 4, 'n_estimators': 10}
50377.344409590376 {'max_features': 4, 'n_estimators': 30}
58663.84733372485 {'max_features': 6, 'n_estimators': 3}
52006.15355973719 {'max_features': 6, 'n_estimators': 10}
50146.465964159885 {'max_features': 6, 'n_estimators': 30}
57869.25504027614 {'max_features': 8, 'n_estimators': 3}
51711.09443660957 {'max_features': 8, 'n_estimators': 10}
49682.25345942335 {'max_features': 8, 'n_estimators': 30}
62895.088889905004 {'bootstrap': False, 'max_features': 2, 'n_estimators': 3}
54658.14484390074 {'bootstrap': False, 'max_features': 2, 'n_estimators': 10}
59470.399594730654 {'bootstrap': False, 'max_features': 3, 'n_estimators': 3}
52725.01091081235 {'bootstrap': False, 'max_features': 3, 'n_estimators': 10}
57490.612956065226 {'bootstrap': False, 'max_features': 4, 'n_estimators': 3}
51009.51445842374 {'bootstrap': False, 'max_features': 4, 'n_estimators': 10}

```

In this example, we obtain the best solution by setting the `max_features` hyperparameter to 8, and the `n_estimators` hyperparameter to 30. The RMSE score for this combination is 49,682, which is slightly better than the score you got earlier using the default hyperparameter values (which was 50,182). Congratulations, you have successfully fine-tuned your best model!



Don't forget that you can treat some of the data preparation steps as hyperparameters. For example, the grid search will automatically find out whether or not to add a feature you were not sure about (e.g., using the `add_bedrooms_per_room` hyperparameter of your `CombinedAttributesAdder` transformer). It may similarly be used to automatically find the best way to handle outliers, missing features, feature selection, and more.

Randomized Search

The grid search approach is fine when you are exploring relatively few combinations, like in the previous example, but when the hyperparameter *search space* is large, it is often preferable to use `RandomizedSearchCV` instead. This class can be used in much the same way as the `GridSearchCV` class, but instead of trying out all possible combinations, it evaluates a given number of random combinations by selecting a random value for each hyperparameter at every iteration. This approach has two main benefits:

- If you let the randomized search run for, say, 1,000 iterations, this approach will explore 1,000 different values for each hyperparameter (instead of just a few values per hyperparameter with the grid search approach).
- You have more control over the computing budget you want to allocate to hyperparameter search, simply by setting the number of iterations.

Ensemble Methods

Another way to fine-tune your system is to try to combine the models that perform best. The group (or “ensemble”) will often perform better than the best individual model (just like Random Forests perform better than the individual Decision Trees they rely on), especially if the individual models make very different types of errors. We will cover this topic in more detail in [Chapter 7](#).

Analyze the Best Models and Their Errors

You will often gain good insights on the problem by inspecting the best models. For example, the `RandomForestRegressor` can indicate the relative importance of each attribute for making accurate predictions:

```
>>> feature_importances = grid_search.best_estimator_.feature_importances_
>>> feature_importances
array([7.33442355e-02, 6.29090705e-02, 4.11437985e-02, 1.46726854e-02,
       1.41064835e-02, 1.48742809e-02, 1.42575993e-02, 3.66158981e-01,
       5.64191792e-02, 1.08792957e-01, 5.33510773e-02, 1.03114883e-02,
       1.64780994e-01, 6.02803867e-05, 1.96041560e-03, 2.85647464e-03])
```

Let’s display these importance scores next to their corresponding attribute names:

```
>>> extra_attribs = ["rooms_per_hhold", "pop_per_hhold", "bedrooms_per_room"]
>>> cat_encoder = full_pipeline.named_transformers_["cat"]
>>> cat_one_hot_attribs = list(cat_encoder.categories_[0])
>>> attributes = num_attribs + extra_attribs + cat_one_hot_attribs
>>> sorted(zip(feature_importances, attributes), reverse=True)
[(0.3661589806181342, 'median_income'),
 (0.1647809935615905, 'INLAND'),
 (0.10879295677551573, 'pop_per_hhold'),
 (0.07334423551601242, 'longitude'),
 (0.0629090704826203, 'latitude'),
 (0.05641917918195401, 'rooms_per_hhold'),
 (0.05335107734767581, 'bedrooms_per_room'),
 (0.041143798478729635, 'housing_median_age'),
 (0.014874280890402767, 'population'),
 (0.014672685420543237, 'total_rooms'),
 (0.014257599323407807, 'households'),
 (0.014106483453584102, 'total_bedrooms'),
 (0.010311488326303787, '<1H OCEAN'),
 (0.002856474637320158, 'NEAR OCEAN'),
```

```
(0.00196041559947807, 'NEAR BAY'),  
(6.028038672736599e-05, 'ISLAND')]
```

With this information, you may want to try dropping some of the less useful features (e.g., apparently only one `ocean_proximity` category is really useful, so you could try dropping the others).

You should also look at the specific errors that your system makes, then try to understand why it makes them and what could fix the problem (adding extra features or, on the contrary, getting rid of uninformative ones, cleaning up outliers, etc.).

Evaluate Your System on the Test Set

After tweaking your models for a while, you eventually have a system that performs sufficiently well. Now is the time to evaluate the final model on the test set. There is nothing special about this process; just get the predictors and the labels from your test set, run your `full_pipeline` to transform the data (call `transform()`, *not* `fit_transform()`, you do not want to fit the test set!), and evaluate the final model on the test set:

```
final_model = grid_search.best_estimator_  
  
X_test = strat_test_set.drop("median_house_value", axis=1)  
y_test = strat_test_set["median_house_value"].copy()  
  
X_test_prepared = full_pipeline.transform(X_test)  
  
final_predictions = final_model.predict(X_test_prepared)  
  
final_mse = mean_squared_error(y_test, final_predictions)  
final_rmse = np.sqrt(final_mse) # => evaluates to 47,730.2
```

In some cases, such a point estimate of the generalization error will not be quite enough to convince you to launch: what if it is just 0.1% better than the model currently in production? You might want to have an idea of how precise this estimate is. For this, you can compute a 95% *confidence interval* for the generalization error using `scipy.stats.t.interval()`:

```
>>> from scipy import stats  
>>> confidence = 0.95  
>>> squared_errors = (final_predictions - y_test) ** 2  
>>> np.sqrt(stats.t.interval(confidence, len(squared_errors) - 1,  
...                          loc=squared_errors.mean(),  
...                          scale=stats.sem(squared_errors)))  
...  
...  
array([45685.10470776, 49691.25001878])
```

The performance will usually be slightly worse than what you measured using cross-validation if you did a lot of hyperparameter tuning (because your system ends up fine-tuned to perform well on the validation data, and will likely not perform as well

on unknown datasets). It is not the case in this example, but when this happens you must resist the temptation to tweak the hyperparameters to make the numbers look good on the test set; the improvements would be unlikely to generalize to new data.

Now comes the project prelaunch phase: you need to present your solution (highlighting what you have learned, what worked and what did not, what assumptions were made, and what your system's limitations are), document everything, and create nice presentations with clear visualizations and easy-to-remember statements (e.g., “the median income is the number one predictor of housing prices”). In this California housing example, the final performance of the system is not better than the experts', but it may still be a good idea to launch it, especially if this frees up some time for the experts so they can work on more interesting and productive tasks.

Launch, Monitor, and Maintain Your System

Perfect, you got approval to launch! You need to get your solution ready for production, in particular by plugging the production input data sources into your system and writing tests.

You also need to write monitoring code to check your system's live performance at regular intervals and trigger alerts when it drops. This is important to catch not only sudden breakage, but also performance degradation. This is quite common because models tend to “rot” as data evolves over time, unless the models are regularly trained on fresh data.

Evaluating your system's performance will require sampling the system's predictions and evaluating them. This will generally require a human analysis. These analysts may be field experts, or workers on a crowdsourcing platform (such as Amazon Mechanical Turk or CrowdFlower). Either way, you need to plug the human evaluation pipeline into your system.

You should also make sure you evaluate the system's input data quality. Sometimes performance will degrade slightly because of a poor quality signal (e.g., a malfunctioning sensor sending random values, or another team's output becoming stale), but it may take a while before your system's performance degrades enough to trigger an alert. If you monitor your system's inputs, you may catch this earlier. Monitoring the inputs is particularly important for online learning systems.

Finally, you will generally want to train your models on a regular basis using fresh data. You should automate this process as much as possible. If you don't, you are very likely to refresh your model only every six months (at best), and your system's performance may fluctuate severely over time. If your system is an online learning system, you should make sure you save snapshots of its state at regular intervals so you can easily roll back to a previously working state.

Try It Out!

Hopefully this chapter gave you a good idea of what a Machine Learning project looks like, and showed you some of the tools you can use to train a great system. As you can see, much of the work is in the data preparation step, building monitoring tools, setting up human evaluation pipelines, and automating regular model training. The Machine Learning algorithms are also important, of course, but it is probably preferable to be comfortable with the overall process and know three or four algorithms well rather than to spend all your time exploring advanced algorithms and not enough time on the overall process.

So, if you have not already done so, now is a good time to pick up a laptop, select a dataset that you are interested in, and try to go through the whole process from A to Z. A good place to start is on a competition website such as <http://kaggle.com/>: you will have a dataset to play with, a clear goal, and people to share the experience with.

Exercises

Using this chapter's housing dataset:

1. Try a Support Vector Machine regressor (`sklearn.svm.SVR`), with various hyperparameters such as `kernel="linear"` (with various values for the `C` hyperparameter) or `kernel="rbf"` (with various values for the `C` and `gamma` hyperparameters). Don't worry about what these hyperparameters mean for now. How does the best SVR predictor perform?
2. Try replacing `GridSearchCV` with `RandomizedSearchCV`.
3. Try adding a transformer in the preparation pipeline to select only the most important attributes.
4. Try creating a single pipeline that does the full data preparation plus the final prediction.
5. Automatically explore some preparation options using `GridSearchCV`.

Solutions to these exercises are available in the online Jupyter notebooks at <https://github.com/ageron/handson-ml2>.

Classification



With Early Release ebooks, you get books in their earliest form—the author’s raw and unedited content as he or she writes—so you can take advantage of these technologies long before the official release of these titles. The following will be Chapter 3 in the final release of the book.

In [Chapter 1](#) we mentioned that the most common supervised learning tasks are regression (predicting values) and classification (predicting classes). In [Chapter 2](#) we explored a regression task, predicting housing values, using various algorithms such as Linear Regression, Decision Trees, and Random Forests (which will be explained in further detail in later chapters). Now we will turn our attention to classification systems.

MNIST

In this chapter, we will be using the MNIST dataset, which is a set of 70,000 small images of digits handwritten by high school students and employees of the US Census Bureau. Each image is labeled with the digit it represents. This set has been studied so much that it is often called the “Hello World” of Machine Learning: whenever people come up with a new classification algorithm, they are curious to see how it will perform on MNIST. Whenever someone learns Machine Learning, sooner or later they tackle MNIST.

Scikit-Learn provides many helper functions to download popular datasets. MNIST is one of them. The following code fetches the MNIST dataset:¹

¹ By default Scikit-Learn caches downloaded datasets in a directory called `$HOME/scikit_learn_data`.

```

>>> from sklearn.datasets import fetch_openml
>>> mnist = fetch_openml('mnist_784', version=1)
>>> mnist.keys()
dict_keys(['data', 'target', 'feature_names', 'DESCR', 'details',
           'categories', 'url'])

```

Datasets loaded by Scikit-Learn generally have a similar dictionary structure including:

- A DESCR key describing the dataset
- A data key containing an array with one row per instance and one column per feature
- A target key containing an array with the labels

Let's look at these arrays:

```

>>> X, y = mnist["data"], mnist["target"]
>>> X.shape
(70000, 784)
>>> y.shape
(70000,)

```

There are 70,000 images, and each image has 784 features. This is because each image is 28×28 pixels, and each feature simply represents one pixel's intensity, from 0 (white) to 255 (black). Let's take a peek at one digit from the dataset. All you need to do is grab an instance's feature vector, reshape it to a 28×28 array, and display it using Matplotlib's `imshow()` function:

```

import matplotlib as mpl
import matplotlib.pyplot as plt

some_digit = X[0]
some_digit_image = some_digit.reshape(28, 28)

plt.imshow(some_digit_image, cmap = mpl.cm.binary, interpolation="nearest")
plt.axis("off")
plt.show()

```



This looks like a 5, and indeed that's what the label tells us:

```
>>> y[0]
'5'
```

Note that the label is a string. We prefer numbers, so let's cast `y` to integers:

```
>>> y = y.astype(np.uint8)
```

Figure 3-1 shows a few more images from the MNIST dataset to give you a feel for the complexity of the classification task.



Figure 3-1. A few digits from the MNIST dataset

But wait! You should always create a test set and set it aside before inspecting the data closely. The MNIST dataset is actually already split into a training set (the first 60,000 images) and a test set (the last 10,000 images):

```
X_train, X_test, y_train, y_test = X[:60000], X[60000:], y[:60000], y[60000:]
```

The training set is already shuffled for us, which is good as this guarantees that all cross-validation folds will be similar (you don't want one fold to be missing some digits). Moreover, some learning algorithms are sensitive to the order of the training

instances, and they perform poorly if they get many similar instances in a row. Shuffling the dataset ensures that this won't happen.²

Training a Binary Classifier

Let's simplify the problem for now and only try to identify one digit—for example, the number 5. This “5-detector” will be an example of a *binary classifier*, capable of distinguishing between just two classes, 5 and not-5. Let's create the target vectors for this classification task:

```
y_train_5 = (y_train == 5) # True for all 5s, False for all other digits.
y_test_5 = (y_test == 5)
```

Okay, now let's pick a classifier and train it. A good place to start is with a *Stochastic Gradient Descent* (SGD) classifier, using Scikit-Learn's `SGDClassifier` class. This classifier has the advantage of being capable of handling very large datasets efficiently. This is in part because SGD deals with training instances independently, one at a time (which also makes SGD well suited for *online learning*), as we will see later. Let's create an `SGDClassifier` and train it on the whole training set:

```
from sklearn.linear_model import SGDClassifier

sgd_clf = SGDClassifier(random_state=42)
sgd_clf.fit(X_train, y_train_5)
```



The `SGDClassifier` relies on randomness during training (hence the name “stochastic”). If you want reproducible results, you should set the `random_state` parameter.

Now you can use it to detect images of the number 5:

```
>>> sgd_clf.predict([some_digit])
array([ True])
```

The classifier guesses that this image represents a 5 (True). Looks like it guessed right in this particular case! Now, let's evaluate this model's performance.

Performance Measures

Evaluating a classifier is often significantly trickier than evaluating a regressor, so we will spend a large part of this chapter on this topic. There are many performance

² Shuffling may be a bad idea in some contexts—for example, if you are working on time series data (such as stock market prices or weather conditions). We will explore this in the next chapters.

measures available, so grab another coffee and get ready to learn many new concepts and acronyms!

Measuring Accuracy Using Cross-Validation

A good way to evaluate a model is to use cross-validation, just as you did in [Chapter 2](#).

Implementing Cross-Validation

Occasionally you will need more control over the cross-validation process than what Scikit-Learn provides off-the-shelf. In these cases, you can implement cross-validation yourself; it is actually fairly straightforward. The following code does roughly the same thing as Scikit-Learn's `cross_val_score()` function, and prints the same result:

```
from sklearn.model_selection import StratifiedKFold
from sklearn.base import clone

skfolds = StratifiedKFold(n_splits=3, random_state=42)

for train_index, test_index in skfolds.split(X_train, y_train_5):
    clone_clf = clone(sgd_clf)
    X_train_folds = X_train[train_index]
    y_train_folds = y_train_5[train_index]
    X_test_fold = X_train[test_index]
    y_test_fold = y_train_5[test_index]

    clone_clf.fit(X_train_folds, y_train_folds)
    y_pred = clone_clf.predict(X_test_fold)
    n_correct = sum(y_pred == y_test_fold)
    print(n_correct / len(y_pred)) # prints 0.9502, 0.96565 and 0.96495
```

The `StratifiedKFold` class performs stratified sampling (as explained in [Chapter 2](#)) to produce folds that contain a representative ratio of each class. At each iteration the code creates a clone of the classifier, trains that clone on the training folds, and makes predictions on the test fold. Then it counts the number of correct predictions and outputs the ratio of correct predictions.

Let's use the `cross_val_score()` function to evaluate your `SGDClassifier` model using K-fold cross-validation, with three folds. Remember that K-fold cross-validation means splitting the training set into K-folds (in this case, three), then making predictions and evaluating them on each fold using a model trained on the remaining folds (see [Chapter 2](#)):

```
>>> from sklearn.model_selection import cross_val_score
>>> cross_val_score(sgd_clf, X_train, y_train_5, cv=3, scoring="accuracy")
array([0.96355, 0.93795, 0.95615])
```

Wow! Above 93% *accuracy* (ratio of correct predictions) on all cross-validation folds? This looks amazing, doesn't it? Well, before you get too excited, let's look at a very dumb classifier that just classifies every single image in the "not-5" class:

```
from sklearn.base import BaseEstimator

class Never5Classifier(BaseEstimator):
    def fit(self, X, y=None):
        pass
    def predict(self, X):
        return np.zeros((len(X), 1), dtype=bool)
```

Can you guess this model's accuracy? Let's find out:

```
>>> never_5_clf = Never5Classifier()
>>> cross_val_score(never_5_clf, X_train, y_train_5, cv=3, scoring="accuracy")
array([0.91125, 0.90855, 0.90915])
```

That's right, it has over 90% accuracy! This is simply because only about 10% of the images are 5s, so if you always guess that an image is *not* a 5, you will be right about 90% of the time. Beats Nostradamus.

This demonstrates why accuracy is generally not the preferred performance measure for classifiers, especially when you are dealing with *skewed datasets* (i.e., when some classes are much more frequent than others).

Confusion Matrix

A much better way to evaluate the performance of a classifier is to look at the *confusion matrix*. The general idea is to count the number of times instances of class A are classified as class B. For example, to know the number of times the classifier confused images of 5s with 3s, you would look in the 5th row and 3rd column of the confusion matrix.

To compute the confusion matrix, you first need to have a set of predictions, so they can be compared to the actual targets. You could make predictions on the test set, but let's keep it untouched for now (remember that you want to use the test set only at the very end of your project, once you have a classifier that you are ready to launch). Instead, you can use the `cross_val_predict()` function:

```
from sklearn.model_selection import cross_val_predict

y_train_pred = cross_val_predict(sgd_clf, X_train, y_train_5, cv=3)
```

Just like the `cross_val_score()` function, `cross_val_predict()` performs K-fold cross-validation, but instead of returning the evaluation scores, it returns the predic-

tions made on each test fold. This means that you get a clean prediction for each instance in the training set (“clean” meaning that the prediction is made by a model that never saw the data during training).

Now you are ready to get the confusion matrix using the `confusion_matrix()` function. Just pass it the target classes (`y_train_5`) and the predicted classes (`y_train_pred`):

```
>>> from sklearn.metrics import confusion_matrix
>>> confusion_matrix(y_train_5, y_train_pred)
array([[53057, 1522],
       [ 1325, 4096]])
```

Each row in a confusion matrix represents an *actual class*, while each column represents a *predicted class*. The first row of this matrix considers non-5 images (the *negative class*): 53,057 of them were correctly classified as non-5s (they are called *true negatives*), while the remaining 1,522 were wrongly classified as 5s (*false positives*). The second row considers the images of 5s (the *positive class*): 1,325 were wrongly classified as non-5s (*false negatives*), while the remaining 4,096 were correctly classified as 5s (*true positives*). A perfect classifier would have only true positives and true negatives, so its confusion matrix would have nonzero values only on its main diagonal (top left to bottom right):

```
>>> y_train_perfect_predictions = y_train_5 # pretend we reached perfection
>>> confusion_matrix(y_train_5, y_train_perfect_predictions)
array([[54579, 0],
       [ 0, 5421]])
```

The confusion matrix gives you a lot of information, but sometimes you may prefer a more concise metric. An interesting one to look at is the accuracy of the positive predictions; this is called the *precision* of the classifier (Equation 3-1).

Equation 3-1. Precision

$$\text{precision} = \frac{TP}{TP + FP}$$

TP is the number of true positives, and FP is the number of false positives.

A trivial way to have perfect precision is to make one single positive prediction and ensure it is correct (precision = 1/1 = 100%). This would not be very useful since the classifier would ignore all but one positive instance. So precision is typically used along with another metric named *recall*, also called *sensitivity* or *true positive rate*

(TPR): this is the ratio of positive instances that are correctly detected by the classifier (Equation 3-2).

Equation 3-2. Recall

$$\text{recall} = \frac{TP}{TP + FN}$$

FN is of course the number of false negatives.

If you are confused about the confusion matrix, Figure 3-2 may help.

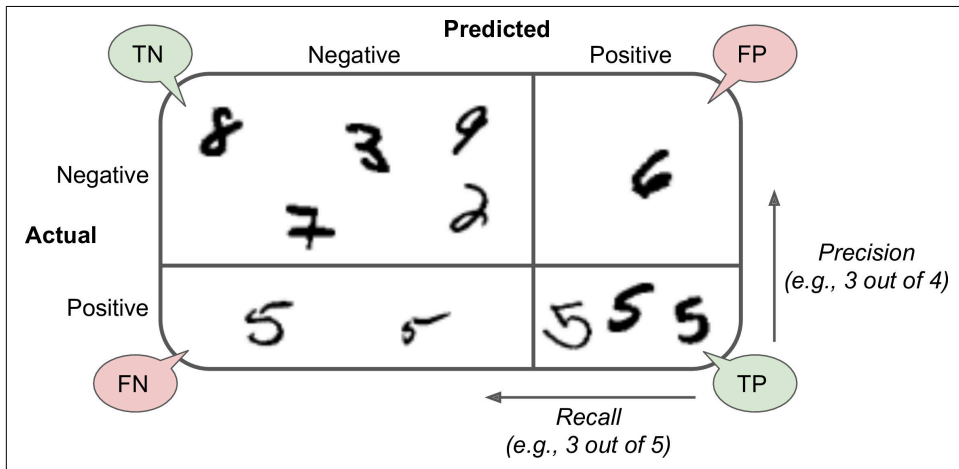

Figure 3-2. An illustrated confusion matrix

Precision and Recall

Scikit-Learn provides several functions to compute classifier metrics, including precision and recall:

```
>>> from sklearn.metrics import precision_score, recall_score
>>> precision_score(y_train_5, y_train_pred) # == 4096 / (4096 + 1522)
0.7290850836596654
>>> recall_score(y_train_5, y_train_pred) # == 4096 / (4096 + 1325)
0.7555801512636044
```

Now your 5-detector does not look as shiny as it did when you looked at its accuracy. When it claims an image represents a 5, it is correct only 72.9% of the time. Moreover, it only detects 75.6% of the 5s.

It is often convenient to combine precision and recall into a single metric called the F_1 score, in particular if you need a simple way to compare two classifiers. The F_1 score is the *harmonic mean* of precision and recall (Equation 3-3). Whereas the regular mean

treats all values equally, the harmonic mean gives much more weight to low values. As a result, the classifier will only get a high F_1 score if both recall and precision are high.

Equation 3-3. F_1

$$F_1 = \frac{2}{\frac{1}{\text{precision}} + \frac{1}{\text{recall}}} = 2 \times \frac{\text{precision} \times \text{recall}}{\text{precision} + \text{recall}} = \frac{TP}{TP + \frac{FN + FP}{2}}$$

To compute the F_1 score, simply call the `f1_score()` function:

```
>>> from sklearn.metrics import f1_score
>>> f1_score(y_train_5, y_train_pred)
0.7420962043663375
```

The F_1 score favors classifiers that have similar precision and recall. This is not always what you want: in some contexts you mostly care about precision, and in other contexts you really care about recall. For example, if you trained a classifier to detect videos that are safe for kids, you would probably prefer a classifier that rejects many good videos (low recall) but keeps only safe ones (high precision), rather than a classifier that has a much higher recall but lets a few really bad videos show up in your product (in such cases, you may even want to add a human pipeline to check the classifier's video selection). On the other hand, suppose you train a classifier to detect shoplifters on surveillance images: it is probably fine if your classifier has only 30% precision as long as it has 99% recall (sure, the security guards will get a few false alerts, but almost all shoplifters will get caught).

Unfortunately, you can't have it both ways: increasing precision reduces recall, and vice versa. This is called the *precision/recall tradeoff*.

Precision/Recall Tradeoff

To understand this tradeoff, let's look at how the `SGDClassifier` makes its classification decisions. For each instance, it computes a score based on a *decision function*, and if that score is greater than a threshold, it assigns the instance to the positive class, or else it assigns it to the negative class. [Figure 3-3](#) shows a few digits positioned from the lowest score on the left to the highest score on the right. Suppose the *decision threshold* is positioned at the central arrow (between the two 5s): you will find 4 true positives (actual 5s) on the right of that threshold, and one false positive (actually a 6). Therefore, with that threshold, the precision is 80% (4 out of 5). But out of 6 actual 5s, the classifier only detects 4, so the recall is 67% (4 out of 6). Now if you raise the threshold (move it to the arrow on the right), the false positive (the 6) becomes a true negative, thereby increasing precision (up to 100% in this case), but one true positive becomes a false negative, decreasing recall down to 50%. Conversely, lowering the threshold increases recall and reduces precision.

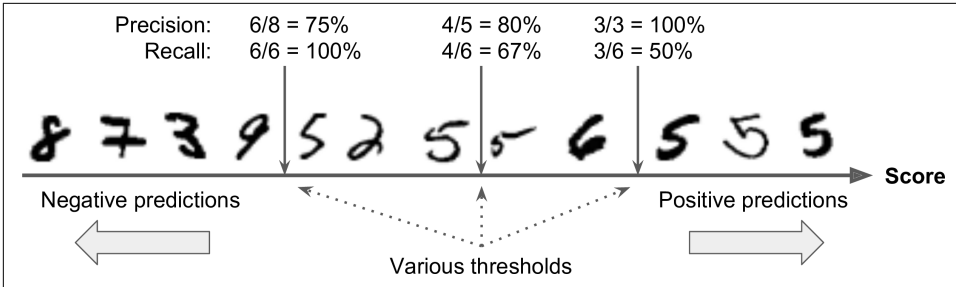

Figure 3-3. Decision threshold and precision/recall tradeoff

Scikit-Learn does not let you set the threshold directly, but it does give you access to the decision scores that it uses to make predictions. Instead of calling the classifier's `predict()` method, you can call its `decision_function()` method, which returns a score for each instance, and then make predictions based on those scores using any threshold you want:

```
>>> y_scores = sgd_clf.decision_function([some_digit])
>>> y_scores
array([2412.53175101])
>>> threshold = 0
>>> y_some_digit_pred = (y_scores > threshold)
array([ True])
```

The `SGDClassifier` uses a threshold equal to 0, so the previous code returns the same result as the `predict()` method (i.e., `True`). Let's raise the threshold:

```
>>> threshold = 8000
>>> y_some_digit_pred = (y_scores > threshold)
>>> y_some_digit_pred
array([False])
```

This confirms that raising the threshold decreases recall. The image actually represents a 5, and the classifier detects it when the threshold is 0, but it misses it when the threshold is increased to 8,000.

Now how do you decide which threshold to use? For this you will first need to get the scores of all instances in the training set using the `cross_val_predict()` function again, but this time specifying that you want it to return decision scores instead of predictions:

```
y_scores = cross_val_predict(sgd_clf, X_train, y_train_5, cv=3,
                             method="decision_function")
```

Now with these scores you can compute precision and recall for all possible thresholds using the `precision_recall_curve()` function:

```

from sklearn.metrics import precision_recall_curve

precisions, recalls, thresholds = precision_recall_curve(y_train_5, y_scores)

```

Finally, you can plot precision and recall as functions of the threshold value using Matplotlib (Figure 3-4):

```

def plot_precision_recall_vs_threshold(precisions, recalls, thresholds):
    plt.plot(thresholds, precisions[:-1], "b--", label="Precision")
    plt.plot(thresholds, recalls[:-1], "g-", label="Recall")
    [...] # highlight the threshold, add the legend, axis label and grid

plot_precision_recall_vs_threshold(precisions, recalls, thresholds)
plt.show()

```

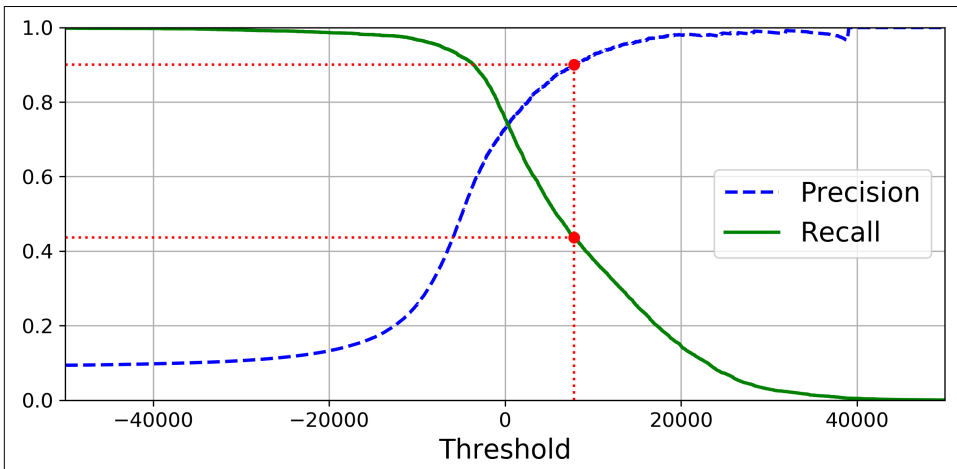

Figure 3-4. Precision and recall versus the decision threshold



You may wonder why the precision curve is bumpier than the recall curve in Figure 3-4. The reason is that precision may sometimes go down when you raise the threshold (although in general it will go up). To understand why, look back at Figure 3-3 and notice what happens when you start from the central threshold and move it just one digit to the right: precision goes from $4/5$ (80%) down to $3/4$ (75%). On the other hand, recall can only go down when the threshold is increased, which explains why its curve looks smooth.

Another way to select a good precision/recall tradeoff is to plot precision directly against recall, as shown in Figure 3-5 (the same threshold as earlier is highlighted).

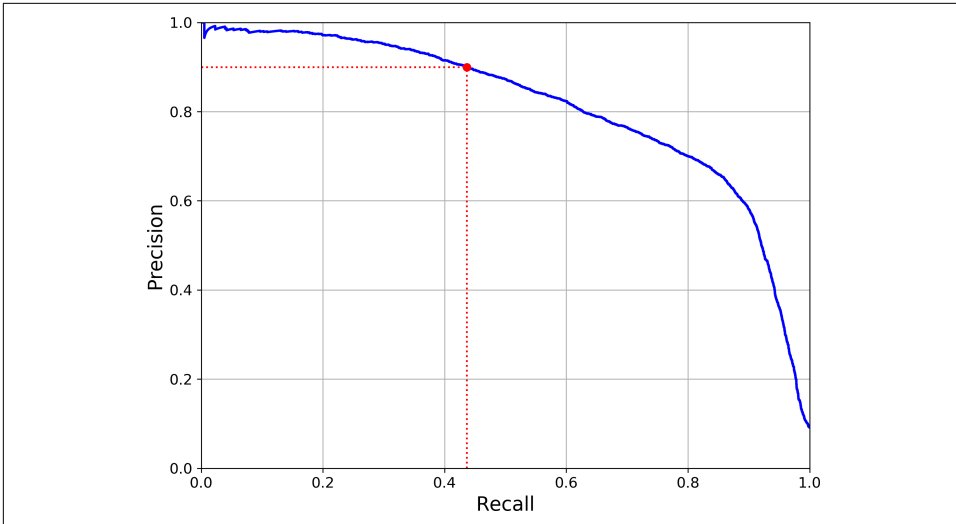

Figure 3-5. Precision versus recall

You can see that precision really starts to fall sharply around 80% recall. You will probably want to select a precision/recall tradeoff just before that drop—for example, at around 60% recall. But of course the choice depends on your project.

So let's suppose you decide to aim for 90% precision. You look up the first plot and find that you need to use a threshold of about 8,000. To be more precise you can search for the lowest threshold that gives you at least 90% precision (`np.argmax()` will give us the first index of the maximum value, which in this case means the first True value):

```
threshold_90_precision = thresholds[np.argmax(precisions >= 0.90)] # ~7816
```

To make predictions (on the training set for now), instead of calling the classifier's `predict()` method, you can just run this code:

```
y_train_pred_90 = (y_scores >= threshold_90_precision)
```

Let's check these predictions' precision and recall:

```
>>> precision_score(y_train_5, y_train_pred_90)
0.9000380083618396
>>> recall_score(y_train_5, y_train_pred_90)
0.4368197749492714
```

Great, you have a 90% precision classifier ! As you can see, it is fairly easy to create a classifier with virtually any precision you want: just set a high enough threshold, and you're done. Hmm, not so fast. A high-precision classifier is not very useful if its recall is too low!



If someone says “let’s reach 99% precision,” you should ask, “at what recall?”

The ROC Curve

The *receiver operating characteristic* (ROC) curve is another common tool used with binary classifiers. It is very similar to the precision/recall curve, but instead of plotting precision versus recall, the ROC curve plots the *true positive rate* (another name for recall) against the *false positive rate*. The FPR is the ratio of negative instances that are incorrectly classified as positive. It is equal to one minus the *true negative rate*, which is the ratio of negative instances that are correctly classified as negative. The TNR is also called *specificity*. Hence the ROC curve plots *sensitivity* (recall) versus $1 - \text{specificity}$.

To plot the ROC curve, you first need to compute the TPR and FPR for various threshold values, using the `roc_curve()` function:

```
from sklearn.metrics import roc_curve

fpr, tpr, thresholds = roc_curve(y_train_5, y_scores)
```

Then you can plot the FPR against the TPR using Matplotlib. This code produces the plot in [Figure 3-6](#):

```
def plot_roc_curve(fpr, tpr, label=None):
    plt.plot(fpr, tpr, linewidth=2, label=label)
    plt.plot([0, 1], [0, 1], 'k--') # dashed diagonal
    [...] # Add axis labels and grid

plot_roc_curve(fpr, tpr)
plt.show()
```

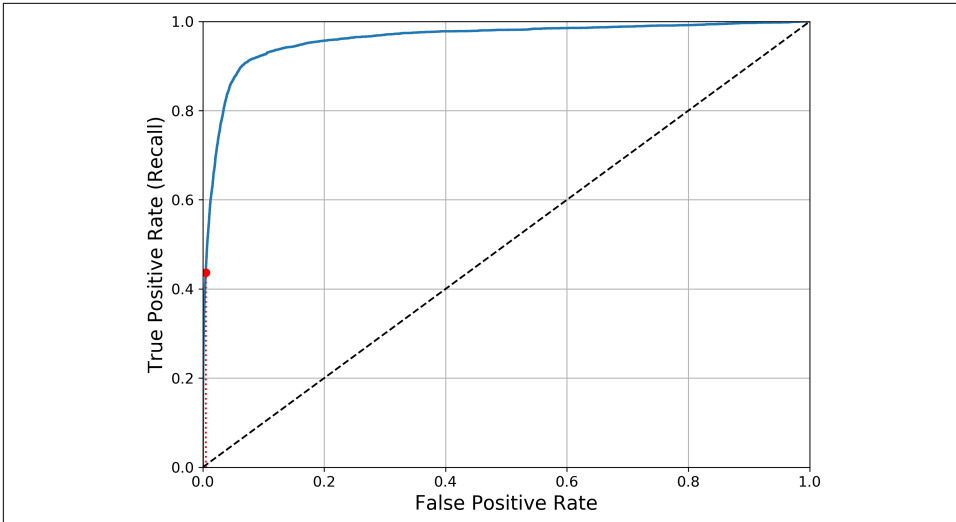

Figure 3-6. ROC curve

Once again there is a tradeoff: the higher the recall (TPR), the more false positives (FPR) the classifier produces. The dotted line represents the ROC curve of a purely random classifier; a good classifier stays as far away from that line as possible (toward the top-left corner).

One way to compare classifiers is to measure the *area under the curve* (AUC). A perfect classifier will have a ROC AUC equal to 1, whereas a purely random classifier will have a ROC AUC equal to 0.5. Scikit-Learn provides a function to compute the ROC AUC:

```
>>> from sklearn.metrics import roc_auc_score
>>> roc_auc_score(y_train_5, y_scores)
0.9611778893101814
```



Since the ROC curve is so similar to the precision/recall (or PR) curve, you may wonder how to decide which one to use. As a rule of thumb, you should prefer the PR curve whenever the positive class is rare or when you care more about the false positives than the false negatives, and the ROC curve otherwise. For example, looking at the previous ROC curve (and the ROC AUC score), you may think that the classifier is really good. But this is mostly because there are few positives (5s) compared to the negatives (non-5s). In contrast, the PR curve makes it clear that the classifier has room for improvement (the curve could be closer to the top-right corner).

Let's train a `RandomForestClassifier` and compare its ROC curve and ROC AUC score to the `SGDClassifier`. First, you need to get scores for each instance in the training set. But due to the way it works (see [Chapter 7](#)), the `RandomForestClassifier` class does not have a `decision_function()` method. Instead it has a `predict_proba()` method. Scikit-Learn classifiers generally have one or the other. The `predict_proba()` method returns an array containing a row per instance and a column per class, each containing the probability that the given instance belongs to the given class (e.g., 70% chance that the image represents a 5):

```
from sklearn.ensemble import RandomForestClassifier

forest_clf = RandomForestClassifier(random_state=42)
y_probas_forest = cross_val_predict(forest_clf, X_train, y_train_5, cv=3,
                                    method="predict_proba")
```

But to plot a ROC curve, you need scores, not probabilities. A simple solution is to use the positive class's probability as the score:

```
y_scores_forest = y_probas_forest[:, 1] # score = proba of positive class
fpr_forest, tpr_forest, thresholds_forest = roc_curve(y_train_5, y_scores_forest)
```

Now you are ready to plot the ROC curve. It is useful to plot the first ROC curve as well to see how they compare ([Figure 3-7](#)):

```
plt.plot(fpr, tpr, "b:", label="SGD")
plot_roc_curve(fpr_forest, tpr_forest, "Random Forest")
plt.legend(loc="lower right")
plt.show()
```

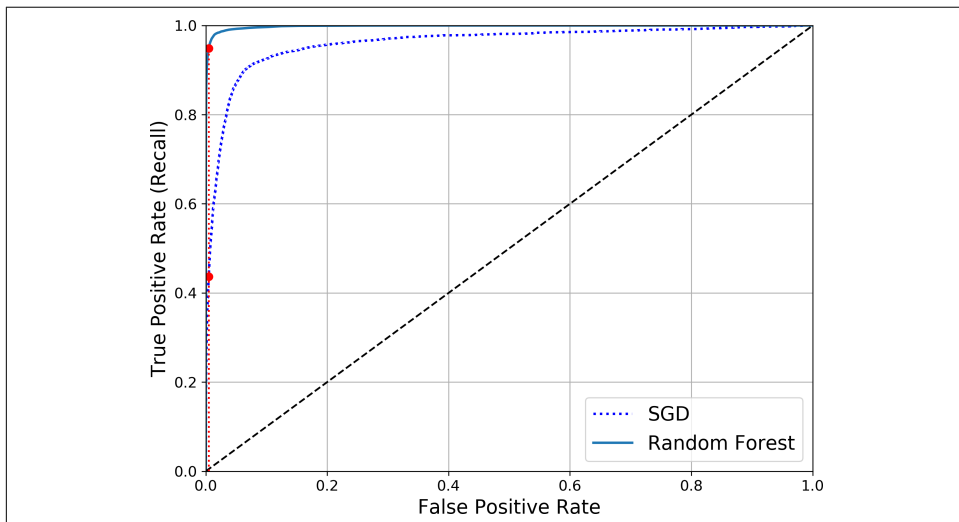

Figure 3-7. Comparing ROC curves

As you can see in [Figure 3-7](#), the `RandomForestClassifier`'s ROC curve looks much better than the `SGDClassifier`'s: it comes much closer to the top-left corner. As a result, its ROC AUC score is also significantly better:

```
>>> roc_auc_score(y_train_5, y_scores_forest)
0.9983436731328145
```

Try measuring the precision and recall scores: you should find 99.0% precision and 86.6% recall. Not too bad!

Hopefully you now know how to train binary classifiers, choose the appropriate metric for your task, evaluate your classifiers using cross-validation, select the precision/recall tradeoff that fits your needs, and compare various models using ROC curves and ROC AUC scores. Now let's try to detect more than just the 5s.

Multiclass Classification

Whereas binary classifiers distinguish between two classes, *multiclass classifiers* (also called *multinomial classifiers*) can distinguish between more than two classes.

Some algorithms (such as Random Forest classifiers or naive Bayes classifiers) are capable of handling multiple classes directly. Others (such as Support Vector Machine classifiers or Linear classifiers) are strictly binary classifiers. However, there are various strategies that you can use to perform multiclass classification using multiple binary classifiers.

For example, one way to create a system that can classify the digit images into 10 classes (from 0 to 9) is to train 10 binary classifiers, one for each digit (a 0-detector, a 1-detector, a 2-detector, and so on). Then when you want to classify an image, you get the decision score from each classifier for that image and you select the class whose classifier outputs the highest score. This is called the *one-versus-all* (OvA) strategy (also called *one-versus-the-rest*).

Another strategy is to train a binary classifier for every pair of digits: one to distinguish 0s and 1s, another to distinguish 0s and 2s, another for 1s and 2s, and so on. This is called the *one-versus-one* (OvO) strategy. If there are N classes, you need to train $N \times (N - 1) / 2$ classifiers. For the MNIST problem, this means training 45 binary classifiers! When you want to classify an image, you have to run the image through all 45 classifiers and see which class wins the most duels. The main advantage of OvO is that each classifier only needs to be trained on the part of the training set for the two classes that it must distinguish.

Some algorithms (such as Support Vector Machine classifiers) scale poorly with the size of the training set, so for these algorithms OvO is preferred since it is faster to train many classifiers on small training sets than training few classifiers on large training sets. For most binary classification algorithms, however, OvA is preferred.

Scikit-Learn detects when you try to use a binary classification algorithm for a multi-class classification task, and it automatically runs OvA (except for SVM classifiers for which it uses OvO). Let's try this with the `SGDClassifier`:

```
>>> sgd_clf.fit(X_train, y_train) # y_train, not y_train_5
>>> sgd_clf.predict([some_digit])
array([5], dtype=uint8)
```

That was easy! This code trains the `SGDClassifier` on the training set using the original target classes from 0 to 9 (`y_train`), instead of the 5-versus-all target classes (`y_train_5`). Then it makes a prediction (a correct one in this case). Under the hood, Scikit-Learn actually trained 10 binary classifiers, got their decision scores for the image, and selected the class with the highest score.

To see that this is indeed the case, you can call the `decision_function()` method. Instead of returning just one score per instance, it now returns 10 scores, one per class:

```
>>> some_digit_scores = sgd_clf.decision_function([some_digit])
>>> some_digit_scores
array([[ -15955.22627845, -38080.96296175, -13326.66694897,
         573.52692379, -17680.6846644 , 2412.53175101,
        -25526.86498156, -12290.15704709, -7946.05205023,
        -10631.35888549]])
```

The highest score is indeed the one corresponding to class 5:

```
>>> np.argmax(some_digit_scores)
5
>>> sgd_clf.classes_
array([0, 1, 2, 3, 4, 5, 6, 7, 8, 9], dtype=uint8)
>>> sgd_clf.classes_[5]
5
```



When a classifier is trained, it stores the list of target classes in its `classes_` attribute, ordered by value. In this case, the index of each class in the `classes_` array conveniently matches the class itself (e.g., the class at index 5 happens to be class 5), but in general you won't be so lucky.

If you want to force ScikitLearn to use one-versus-one or one-versus-all, you can use the `OneVsOneClassifier` or `OneVsRestClassifier` classes. Simply create an instance and pass a binary classifier to its constructor. For example, this code creates a multi-class classifier using the OvO strategy, based on a `SGDClassifier`:

```
>>> from sklearn.multiclass import OneVsOneClassifier
>>> ovo_clf = OneVsOneClassifier(SGDClassifier(random_state=42))
>>> ovo_clf.fit(X_train, y_train)
>>> ovo_clf.predict([some_digit])
```

```
array([5], dtype=uint8)
>>> len(ovo_clf.estimators_)
45
```

Training a `RandomForestClassifier` is just as easy:

```
>>> forest_clf.fit(X_train, y_train)
>>> forest_clf.predict([some_digit])
array([5], dtype=uint8)
```

This time Scikit-Learn did not have to run OvA or OvO because Random Forest classifiers can directly classify instances into multiple classes. You can call `predict_proba()` to get the list of probabilities that the classifier assigned to each instance for each class:

```
>>> forest_clf.predict_proba([some_digit])
array([[0. , 0. , 0.01, 0.08, 0. , 0.9 , 0. , 0. , 0. , 0.01]])
```

You can see that the classifier is fairly confident about its prediction: the 0.9 at the 5th index in the array means that the model estimates a 90% probability that the image represents a 5. It also thinks that the image could instead be a 2, a 3 or a 9, respectively with 1%, 8% and 1% probability.

Now of course you want to evaluate these classifiers. As usual, you want to use cross-validation. Let's evaluate the `SGDClassifier`'s accuracy using the `cross_val_score()` function:

```
>>> cross_val_score(sgd_clf, X_train, y_train, cv=3, scoring="accuracy")
array([0.8489802 , 0.87129356, 0.86988048])
```

It gets over 84% on all test folds. If you used a random classifier, you would get 10% accuracy, so this is not such a bad score, but you can still do much better. For example, simply scaling the inputs (as discussed in [Chapter 2](#)) increases accuracy above 89%:

```
>>> from sklearn.preprocessing import StandardScaler
>>> scaler = StandardScaler()
>>> X_train_scaled = scaler.fit_transform(X_train.astype(np.float64))
>>> cross_val_score(sgd_clf, X_train_scaled, y_train, cv=3, scoring="accuracy")
array([0.89707059, 0.8960948 , 0.90693604])
```

Error Analysis

Of course, if this were a real project, you would follow the steps in your Machine Learning project checklist (see ???): exploring data preparation options, trying out multiple models, shortlisting the best ones and fine-tuning their hyperparameters using `GridSearchCV`, and automating as much as possible, as you did in the previous chapter. Here, we will assume that you have found a promising model and you want to find ways to improve it. One way to do this is to analyze the types of errors it makes.

First, you can look at the confusion matrix. You need to make predictions using the `cross_val_predict()` function, then call the `confusion_matrix()` function, just like you did earlier:

```
>>> y_train_pred = cross_val_predict(sgd_clf, X_train_scaled, y_train, cv=3)
>>> conf_mx = confusion_matrix(y_train, y_train_pred)
>>> conf_mx
array([[5578,  0,  22,  7,  8,  45,  35,  5, 222,  1],
       [  0, 6410,  35,  26,  4,  44,  4,  8, 198, 13],
       [ 28,  27, 5232, 100,  74,  27,  68,  37, 354, 11],
       [ 23,  18,  115, 5254,  2, 209,  26,  38, 373, 73],
       [ 11,  14,  45,  12, 5219,  11,  33,  26, 299, 172],
       [ 26,  16,  31, 173,  54, 4484,  76,  14, 482,  65],
       [ 31,  17,  45,  2,  42,  98, 5556,  3, 123,  1],
       [ 20,  10,  53,  27,  50,  13,  3, 5696, 173, 220],
       [ 17,  64,  47,  91,  3, 125,  24,  11, 5421,  48],
       [ 24,  18,  29,  67, 116,  39,  1, 174, 329, 5152]])
```

That's a lot of numbers. It's often more convenient to look at an image representation of the confusion matrix, using Matplotlib's `matshow()` function:

```
plt.matshow(conf_mx, cmap=plt.cm.gray)
plt.show()
```

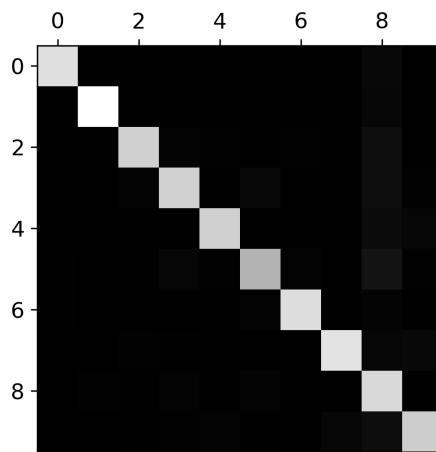

This confusion matrix looks fairly good, since most images are on the main diagonal, which means that they were classified correctly. The 5s look slightly darker than the other digits, which could mean that there are fewer images of 5s in the dataset or that the classifier does not perform as well on 5s as on other digits. In fact, you can verify that both are the case.

Let's focus the plot on the errors. First, you need to divide each value in the confusion matrix by the number of images in the corresponding class, so you can compare error

rates instead of absolute number of errors (which would make abundant classes look unfairly bad):

```
row_sums = conf_mx.sum(axis=1, keepdims=True)
norm_conf_mx = conf_mx / row_sums
```

Now let's fill the diagonal with zeros to keep only the errors, and let's plot the result:

```
np.fill_diagonal(norm_conf_mx, 0)
plt.matshow(norm_conf_mx, cmap=plt.cm.gray)
plt.show()
```

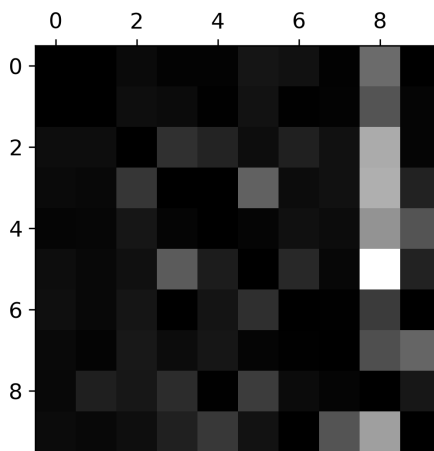

Now you can clearly see the kinds of errors the classifier makes. Remember that rows represent actual classes, while columns represent predicted classes. The column for class 8 is quite bright, which tells you that many images get misclassified as 8s. However, the row for class 8 is not that bad, telling you that actual 8s in general get properly classified as 8s. As you can see, the confusion matrix is not necessarily symmetrical. You can also see that 3s and 5s often get confused (in both directions).

Analyzing the confusion matrix can often give you insights on ways to improve your classifier. Looking at this plot, it seems that your efforts should be spent on reducing the false 8s. For example, you could try to gather more training data for digits that look like 8s (but are not) so the classifier can learn to distinguish them from real 8s. Or you could engineer new features that would help the classifier—for example, writing an algorithm to count the number of closed loops (e.g., 8 has two, 6 has one, 5 has none). Or you could preprocess the images (e.g., using Scikit-Image, Pillow, or OpenCV) to make some patterns stand out more, such as closed loops.

Analyzing individual errors can also be a good way to gain insights on what your classifier is doing and why it is failing, but it is more difficult and time-consuming.

For example, let's plot examples of 3s and 5s (the `plot_digits()` function just uses Matplotlib's `imshow()` function; see this chapter's Jupyter notebook for details):

```
cl_a, cl_b = 3, 5
X_aa = X_train[(y_train == cl_a) & (y_train_pred == cl_a)]
X_ab = X_train[(y_train == cl_a) & (y_train_pred == cl_b)]
X_ba = X_train[(y_train == cl_b) & (y_train_pred == cl_a)]
X_bb = X_train[(y_train == cl_b) & (y_train_pred == cl_b)]

plt.figure(figsize=(8,8))
plt.subplot(221); plot_digits(X_aa[:25], images_per_row=5)
plt.subplot(222); plot_digits(X_ab[:25], images_per_row=5)
plt.subplot(223); plot_digits(X_ba[:25], images_per_row=5)
plt.subplot(224); plot_digits(X_bb[:25], images_per_row=5)
plt.show()
```

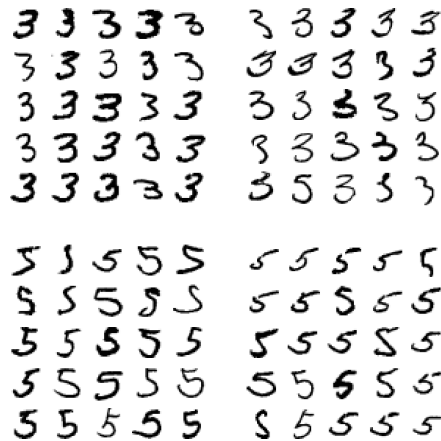

The two 5×5 blocks on the left show digits classified as 3s, and the two 5×5 blocks on the right show images classified as 5s. Some of the digits that the classifier gets wrong (i.e., in the bottom-left and top-right blocks) are so badly written that even a human would have trouble classifying them (e.g., the 5 on the 1st row and 2nd column truly looks like a badly written 3). However, most misclassified images seem like obvious errors to us, and it's hard to understand why the classifier made the mistakes it did.³ The reason is that we used a simple `SGDClassifier`, which is a linear model. All it does is assign a weight per class to each pixel, and when it sees a new image it just sums up the weighted pixel intensities to get a score for each class. So since 3s and 5s differ only by a few pixels, this model will easily confuse them.

³ But remember that our brain is a fantastic pattern recognition system, and our visual system does a lot of complex preprocessing before any information reaches our consciousness, so the fact that it feels simple does not mean that it is.

The main difference between 3s and 5s is the position of the small line that joins the top line to the bottom arc. If you draw a 3 with the junction slightly shifted to the left, the classifier might classify it as a 5, and vice versa. In other words, this classifier is quite sensitive to image shifting and rotation. So one way to reduce the 3/5 confusion would be to preprocess the images to ensure that they are well centered and not too rotated. This will probably help reduce other errors as well.

Multilabel Classification

Until now each instance has always been assigned to just one class. In some cases you may want your classifier to output multiple classes for each instance. For example, consider a face-recognition classifier: what should it do if it recognizes several people on the same picture? Of course it should attach one tag per person it recognizes. Say the classifier has been trained to recognize three faces, Alice, Bob, and Charlie; then when it is shown a picture of Alice and Charlie, it should output [1, 0, 1] (meaning “Alice yes, Bob no, Charlie yes”). Such a classification system that outputs multiple binary tags is called a *multilabel classification* system.

We won’t go into face recognition just yet, but let’s look at a simpler example, just for illustration purposes:

```
from sklearn.neighbors import KNeighborsClassifier

y_train_large = (y_train >= 7)
y_train_odd = (y_train % 2 == 1)
y_multilabel = np.c_[y_train_large, y_train_odd]

knn_clf = KNeighborsClassifier()
knn_clf.fit(X_train, y_multilabel)
```

This code creates a `y_multilabel` array containing two target labels for each digit image: the first indicates whether or not the digit is large (7, 8, or 9) and the second indicates whether or not it is odd. The next lines create a `KNeighborsClassifier` instance (which supports multilabel classification, but not all classifiers do) and we train it using the multiple targets array. Now you can make a prediction, and notice that it outputs two labels:

```
>>> knn_clf.predict([some_digit])
array([[False,  True]])
```

And it gets it right! The digit 5 is indeed not large (`False`) and odd (`True`).

There are many ways to evaluate a multilabel classifier, and selecting the right metric really depends on your project. For example, one approach is to measure the F_1 score for each individual label (or any other binary classifier metric discussed earlier), then simply compute the average score. This code computes the average F_1 score across all labels:

```
>>> y_train_knn_pred = cross_val_predict(knn_clf, X_train, y_multilabel, cv=3)
>>> f1_score(y_multilabel, y_train_knn_pred, average="macro")
0.976410265560605
```

This assumes that all labels are equally important, which may not be the case. In particular, if you have many more pictures of Alice than of Bob or Charlie, you may want to give more weight to the classifier's score on pictures of Alice. One simple option is to give each label a weight equal to its *support* (i.e., the number of instances with that target label). To do this, simply set `average="weighted"` in the preceding code.⁴

Multioutput Classification

The last type of classification task we are going to discuss here is called *multioutput-multiclass classification* (or simply *multioutput classification*). It is simply a generalization of multilabel classification where each label can be multiclass (i.e., it can have more than two possible values).

To illustrate this, let's build a system that removes noise from images. It will take as input a noisy digit image, and it will (hopefully) output a clean digit image, represented as an array of pixel intensities, just like the MNIST images. Notice that the classifier's output is multilabel (one label per pixel) and each label can have multiple values (pixel intensity ranges from 0 to 255). It is thus an example of a multioutput classification system.



The line between classification and regression is sometimes blurry, such as in this example. Arguably, predicting pixel intensity is more akin to regression than to classification. Moreover, multioutput systems are not limited to classification tasks; you could even have a system that outputs multiple labels per instance, including both class labels and value labels.

Let's start by creating the training and test sets by taking the MNIST images and adding noise to their pixel intensities using NumPy's `randint()` function. The target images will be the original images:

```
noise = np.random.randint(0, 100, (len(X_train), 784))
X_train_mod = X_train + noise
noise = np.random.randint(0, 100, (len(X_test), 784))
X_test_mod = X_test + noise
y_train_mod = X_train
y_test_mod = X_test
```

⁴ Scikit-Learn offers a few other averaging options and multilabel classifier metrics; see the documentation for more details.

Let's take a peek at an image from the test set (yes, we're snooping on the test data, so you should be frowning right now):

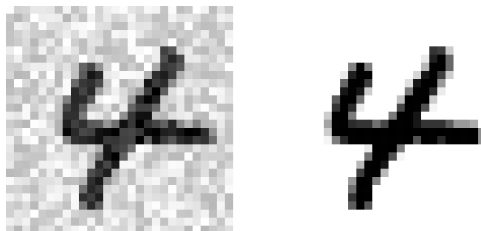

On the left is the noisy input image, and on the right is the clean target image. Now let's train the classifier and make it clean this image:

```
knn_clf.fit(X_train_mod, y_train_mod)
clean_digit = knn_clf.predict([X_test_mod[some_index]])
plot_digit(clean_digit)
```



Looks close enough to the target! This concludes our tour of classification. Hopefully you should now know how to select good metrics for classification tasks, pick the appropriate precision/recall tradeoff, compare classifiers, and more generally build good classification systems for a variety of tasks.

Exercises

1. Try to build a classifier for the MNIST dataset that achieves over 97% accuracy on the test set. Hint: the `KNeighborsClassifier` works quite well for this task; you just need to find good hyperparameter values (try a grid search on the `weights` and `n_neighbors` hyperparameters).
2. Write a function that can shift an MNIST image in any direction (left, right, up, or down) by one pixel.⁵ Then, for each image in the training set, create four shif-

⁵ You can use the `shift()` function from the `scipy.ndimage.interpolation` module. For example, `shift(image, [2, 1], cval=0)` shifts the image 2 pixels down and 1 pixel to the right.

ted copies (one per direction) and add them to the training set. Finally, train your best model on this expanded training set and measure its accuracy on the test set. You should observe that your model performs even better now! This technique of artificially growing the training set is called *data augmentation* or *training set expansion*.

3. Tackle the *Titanic* dataset. A great place to start is on [Kaggle](#).
4. Build a spam classifier (a more challenging exercise):
 - Download examples of spam and ham from [Apache SpamAssassin's public datasets](#).
 - Unzip the datasets and familiarize yourself with the data format.
 - Split the datasets into a training set and a test set.
 - Write a data preparation pipeline to convert each email into a feature vector. Your preparation pipeline should transform an email into a (sparse) vector indicating the presence or absence of each possible word. For example, if all emails only ever contain four words, “Hello,” “how,” “are,” “you,” then the email “Hello you Hello Hello you” would be converted into a vector [1, 0, 0, 1] (meaning [“Hello” is present, “how” is absent, “are” is absent, “you” is present]), or [3, 0, 0, 2] if you prefer to count the number of occurrences of each word.
 - You may want to add hyperparameters to your preparation pipeline to control whether or not to strip off email headers, convert each email to lowercase, remove punctuation, replace all URLs with “URL,” replace all numbers with “NUMBER,” or even perform *stemming* (i.e., trim off word endings; there are Python libraries available to do this).
 - Then try out several classifiers and see if you can build a great spam classifier, with both high recall and high precision.

Solutions to these exercises are available in the online Jupyter notebooks at <https://github.com/ageron/handson-ml2>.

Training Models



With Early Release ebooks, you get books in their earliest form—the author’s raw and unedited content as he or she writes—so you can take advantage of these technologies long before the official release of these titles. The following will be Chapter 4 in the final release of the book.

So far we have treated Machine Learning models and their training algorithms mostly like black boxes. If you went through some of the exercises in the previous chapters, you may have been surprised by how much you can get done without knowing anything about what’s under the hood: you optimized a regression system, you improved a digit image classifier, and you even built a spam classifier from scratch—all this without knowing how they actually work. Indeed, in many situations you don’t really need to know the implementation details.

However, having a good understanding of how things work can help you quickly home in on the appropriate model, the right training algorithm to use, and a good set of hyperparameters for your task. Understanding what’s under the hood will also help you debug issues and perform error analysis more efficiently. Lastly, most of the topics discussed in this chapter will be essential in understanding, building, and training neural networks (discussed in [Part II](#) of this book).

In this chapter, we will start by looking at the Linear Regression model, one of the simplest models there is. We will discuss two very different ways to train it:

- Using a direct “closed-form” equation that directly computes the model parameters that best fit the model to the training set (i.e., the model parameters that minimize the cost function over the training set).

- Using an iterative optimization approach, called Gradient Descent (GD), that gradually tweaks the model parameters to minimize the cost function over the training set, eventually converging to the same set of parameters as the first method. We will look at a few variants of Gradient Descent that we will use again and again when we study neural networks in **Part II**: Batch GD, Mini-batch GD, and Stochastic GD.

Next we will look at Polynomial Regression, a more complex model that can fit non-linear datasets. Since this model has more parameters than Linear Regression, it is more prone to overfitting the training data, so we will look at how to detect whether or not this is the case, using learning curves, and then we will look at several regularization techniques that can reduce the risk of overfitting the training set.

Finally, we will look at two more models that are commonly used for classification tasks: Logistic Regression and Softmax Regression.



There will be quite a few math equations in this chapter, using basic notions of linear algebra and calculus. To understand these equations, you will need to know what vectors and matrices are, how to transpose them, multiply them, and inverse them, and what partial derivatives are. If you are unfamiliar with these concepts, please go through the linear algebra and calculus introductory tutorials available as Jupyter notebooks in the online supplemental material. For those who are truly allergic to mathematics, you should still go through this chapter and simply skip the equations; hopefully, the text will be sufficient to help you understand most of the concepts.

Linear Regression

In **Chapter 1**, we looked at a simple regression model of life satisfaction: *life_satisfaction* = $\theta_0 + \theta_1 \times \text{GDP_per_capita}$.

This model is just a linear function of the input feature `GDP_per_capita`. θ_0 and θ_1 are the model's parameters.

More generally, a linear model makes a prediction by simply computing a weighted sum of the input features, plus a constant called the *bias term* (also called the *intercept term*), as shown in **Equation 4-1**.

Equation 4-1. Linear Regression model prediction

$$\hat{y} = \theta_0 + \theta_1 x_1 + \theta_2 x_2 + \dots + \theta_n x_n$$

- \hat{y} is the predicted value.

- n is the number of features.
- x_i is the i^{th} feature value.
- θ_j is the j^{th} model parameter (including the bias term θ_0 and the feature weights $\theta_1, \theta_2, \dots, \theta_n$).

This can be written much more concisely using a vectorized form, as shown in [Equation 4-2](#).

Equation 4-2. Linear Regression model prediction (vectorized form)

$$\hat{y} = h_{\theta}(\mathbf{x}) = \boldsymbol{\theta} \cdot \mathbf{x}$$

- $\boldsymbol{\theta}$ is the model's *parameter vector*, containing the bias term θ_0 and the feature weights θ_1 to θ_n .
- \mathbf{x} is the instance's *feature vector*, containing x_0 to x_n , with x_0 always equal to 1.
- $\boldsymbol{\theta} \cdot \mathbf{x}$ is the dot product of the vectors $\boldsymbol{\theta}$ and \mathbf{x} , which is of course equal to $\theta_0 x_0 + \theta_1 x_1 + \theta_2 x_2 + \dots + \theta_n x_n$.
- h_{θ} is the hypothesis function, using the model parameters $\boldsymbol{\theta}$.



In Machine Learning, vectors are often represented as *column vectors*, which are 2D arrays with a single column. If $\boldsymbol{\theta}$ and \mathbf{x} are column vectors, then the prediction is: $\hat{y} = \boldsymbol{\theta}^T \mathbf{x}$, where $\boldsymbol{\theta}^T$ is the *transpose* of $\boldsymbol{\theta}$ (a row vector instead of a column vector) and $\boldsymbol{\theta}^T \mathbf{x}$ is the matrix multiplication of $\boldsymbol{\theta}^T$ and \mathbf{x} . It is of course the same prediction, except it is now represented as a single cell matrix rather than a scalar value. In this book we will use this notation to avoid switching between dot products and matrix multiplications.

Okay, that's the Linear Regression model, so now how do we train it? Well, recall that training a model means setting its parameters so that the model best fits the training set. For this purpose, we first need a measure of how well (or poorly) the model fits the training data. In [Chapter 2](#) we saw that the most common performance measure of a regression model is the Root Mean Square Error (RMSE) ([Equation 2-1](#)). Therefore, to train a Linear Regression model, you need to find the value of $\boldsymbol{\theta}$ that minimizes the RMSE. In practice, it is simpler to minimize the Mean Square Error (MSE)

than the RMSE, and it leads to the same result (because the value that minimizes a function also minimizes its square root).¹

The MSE of a Linear Regression hypothesis h_{θ} on a training set \mathbf{X} is calculated using [Equation 4-3](#).

Equation 4-3. MSE cost function for a Linear Regression model

$$\text{MSE}(\mathbf{X}, h_{\theta}) = \frac{1}{m} \sum_{i=1}^m (\theta^T \mathbf{x}^{(i)} - y^{(i)})^2$$

Most of these notations were presented in [Chapter 2](#) (see “Notations” on page 43). The only difference is that we write h_{θ} instead of just h in order to make it clear that the model is parametrized by the vector θ . To simplify notations, we will just write $\text{MSE}(\theta)$ instead of $\text{MSE}(\mathbf{X}, h_{\theta})$.

The Normal Equation

To find the value of θ that minimizes the cost function, there is a *closed-form solution*—in other words, a mathematical equation that gives the result directly. This is called the *Normal Equation* ([Equation 4-4](#)).²

Equation 4-4. Normal Equation

$$\hat{\theta} = (\mathbf{X}^T \mathbf{X})^{-1} \mathbf{X}^T \mathbf{y}$$

- $\hat{\theta}$ is the value of θ that minimizes the cost function.
- \mathbf{y} is the vector of target values containing $y^{(1)}$ to $y^{(m)}$.

Let’s generate some linear-looking data to test this equation on ([Figure 4-1](#)):

```
import numpy as np

X = 2 * np.random.rand(100, 1)
y = 4 + 3 * X + np.random.randn(100, 1)
```

¹ It is often the case that a learning algorithm will try to optimize a different function than the performance measure used to evaluate the final model. This is generally because that function is easier to compute, because it has useful differentiation properties that the performance measure lacks, or because we want to constrain the model during training, as we will see when we discuss regularization.

² The demonstration that this returns the value of θ that minimizes the cost function is outside the scope of this book.

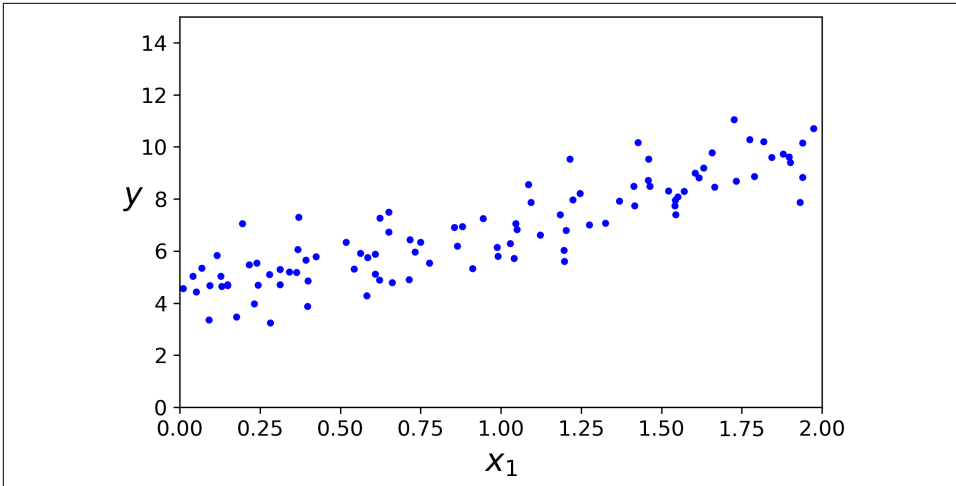

Figure 4-1. Randomly generated linear dataset

Now let's compute $\hat{\theta}$ using the Normal Equation. We will use the `inv()` function from NumPy's Linear Algebra module (`np.linalg`) to compute the inverse of a matrix, and the `dot()` method for matrix multiplication:

```
X_b = np.c_[np.ones((100, 1)), X] # add x0 = 1 to each instance
theta_best = np.linalg.inv(X_b.T.dot(X_b)).dot(X_b.T).dot(y)
```

The actual function that we used to generate the data is $y = 4 + 3x_1 + \text{Gaussian noise}$. Let's see what the equation found:

```
>>> theta_best
array([[4.21509616],
       [2.77011339]])
```

We would have hoped for $\theta_0 = 4$ and $\theta_1 = 3$ instead of $\theta_0 = 4.215$ and $\theta_1 = 2.770$. Close enough, but the noise made it impossible to recover the exact parameters of the original function.

Now you can make predictions using $\hat{\theta}$:

```
>>> X_new = np.array([[0], [2]])
>>> X_new_b = np.c_[np.ones((2, 1)), X_new] # add x0 = 1 to each instance
>>> y_predict = X_new_b.dot(theta_best)
>>> y_predict
array([[4.21509616],
       [9.75532293]])
```

Let's plot this model's predictions (Figure 4-2):

```
plt.plot(X_new, y_predict, "r-")
plt.plot(X, y, "b.")
```

```
plt.axis([0, 2, 0, 15])
plt.show()
```

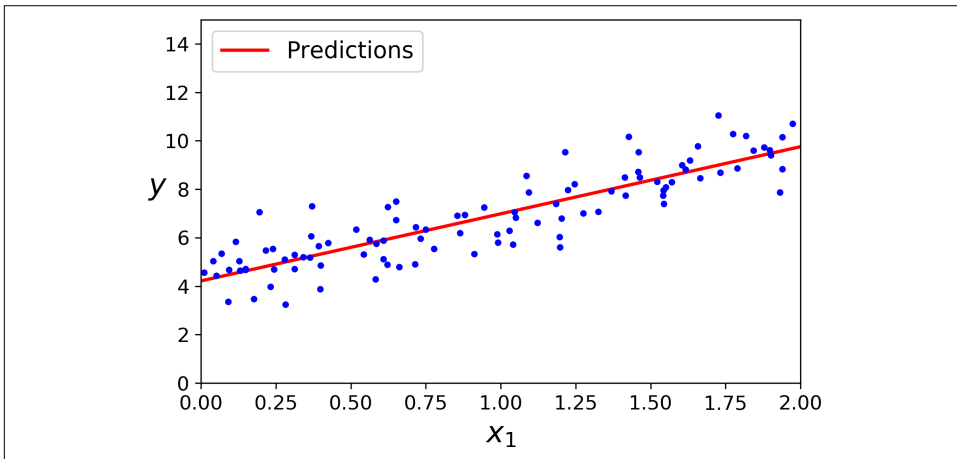

Figure 4-2. Linear Regression model predictions

Performing linear regression using Scikit-Learn is quite simple:³

```
>>> from sklearn.linear_model import LinearRegression
>>> lin_reg = LinearRegression()
>>> lin_reg.fit(X, y)
>>> lin_reg.intercept_, lin_reg.coef_
(array([4.21509616]), array([[2.77011339]]))
>>> lin_reg.predict(X_new)
array([[4.21509616],
       [9.75532293]])
```

The `LinearRegression` class is based on the `scipy.linalg.lstsq()` function (the name stands for “least squares”), which you could call directly:

```
>>> theta_best_svd, residuals, rank, s = np.linalg.lstsq(X_b, y, rcond=1e-6)
>>> theta_best_svd
array([[4.21509616],
       [2.77011339]])
```

This function computes $\hat{\theta} = \mathbf{X}^+ \mathbf{y}$, where \mathbf{X}^+ is the *pseudoinverse* of \mathbf{X} (specifically the Moore-Penrose inverse). You can use `np.linalg.pinv()` to compute the pseudoinverse directly:

```
>>> np.linalg.pinv(X_b).dot(y)
array([[4.21509616],
       [2.77011339]])
```

³ Note that Scikit-Learn separates the bias term (`intercept_`) from the feature weights (`coef_`).

The pseudoinverse itself is computed using a standard matrix factorization technique called *Singular Value Decomposition* (SVD) that can decompose the training set matrix \mathbf{X} into the matrix multiplication of three matrices $\mathbf{U} \mathbf{\Sigma} \mathbf{V}^T$ (see `numpy.linalg.svd()`). The pseudoinverse is computed as $\mathbf{X}^+ = \mathbf{V}\mathbf{\Sigma}^+\mathbf{U}^T$. To compute the matrix $\mathbf{\Sigma}^+$, the algorithm takes $\mathbf{\Sigma}$ and sets to zero all values smaller than a tiny threshold value, then it replaces all the non-zero values with their inverse, and finally it transposes the resulting matrix. This approach is more efficient than computing the Normal Equation, plus it handles edge cases nicely: indeed, the Normal Equation may not work if the matrix $\mathbf{X}^T\mathbf{X}$ is not invertible (i.e., singular), such as if $m < n$ or if some features are redundant, but the pseudoinverse is always defined.

Computational Complexity

The Normal Equation computes the inverse of $\mathbf{X}^T \mathbf{X}$, which is an $(n + 1) \times (n + 1)$ matrix (where n is the number of features). The *computational complexity* of inverting such a matrix is typically about $O(n^{2.4})$ to $O(n^3)$ (depending on the implementation). In other words, if you double the number of features, you multiply the computation time by roughly $2^{2.4} = 5.3$ to $2^3 = 8$.

The SVD approach used by Scikit-Learn's `LinearRegression` class is about $O(n^2)$. If you double the number of features, you multiply the computation time by roughly 4.



Both the Normal Equation and the SVD approach get very slow when the number of features grows large (e.g., 100,000). On the positive side, both are linear with regards to the number of instances in the training set (they are $O(m)$), so they handle large training sets efficiently, provided they can fit in memory.

Also, once you have trained your Linear Regression model (using the Normal Equation or any other algorithm), predictions are very fast: the computational complexity is linear with regards to both the number of instances you want to make predictions on and the number of features. In other words, making predictions on twice as many instances (or twice as many features) will just take roughly twice as much time.

Now we will look at very different ways to train a Linear Regression model, better suited for cases where there are a large number of features, or too many training instances to fit in memory.

Gradient Descent

Gradient Descent is a very generic optimization algorithm capable of finding optimal solutions to a wide range of problems. The general idea of Gradient Descent is to tweak parameters iteratively in order to minimize a cost function.

Suppose you are lost in the mountains in a dense fog; you can only feel the slope of the ground below your feet. A good strategy to get to the bottom of the valley quickly is to go downhill in the direction of the steepest slope. This is exactly what Gradient Descent does: it measures the local gradient of the error function with regards to the parameter vector θ , and it goes in the direction of descending gradient. Once the gradient is zero, you have reached a minimum!

Concretely, you start by filling θ with random values (this is called *random initialization*), and then you improve it gradually, taking one baby step at a time, each step attempting to decrease the cost function (e.g., the MSE), until the algorithm *converges* to a minimum (see [Figure 4-3](#)).

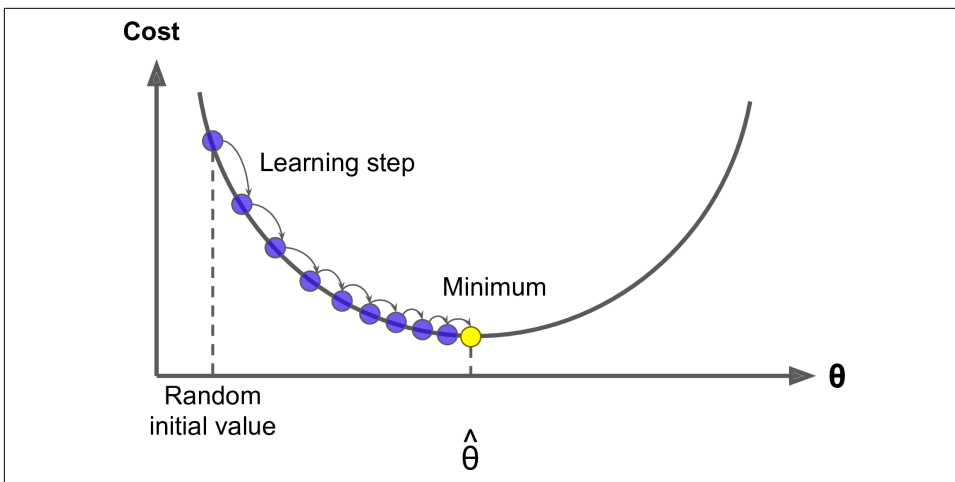

Figure 4-3. Gradient Descent

An important parameter in Gradient Descent is the size of the steps, determined by the *learning rate* hyperparameter. If the learning rate is too small, then the algorithm will have to go through many iterations to converge, which will take a long time (see [Figure 4-4](#)).

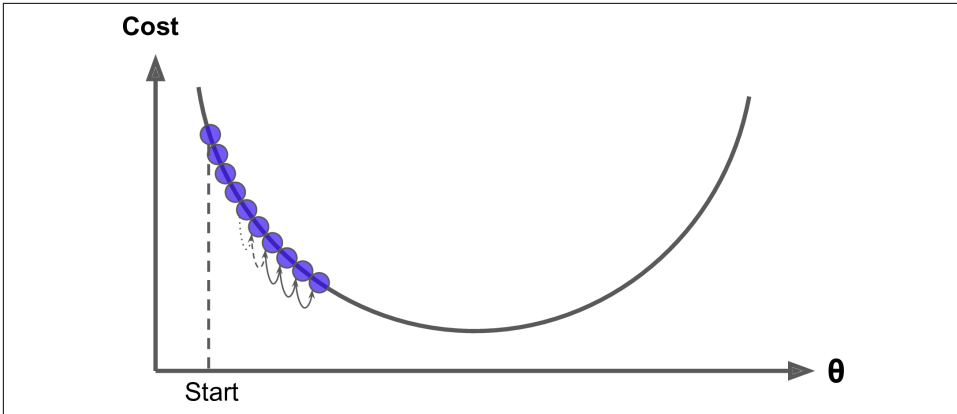

Figure 4-4. Learning rate too small

On the other hand, if the learning rate is too high, you might jump across the valley and end up on the other side, possibly even higher up than you were before. This might make the algorithm diverge, with larger and larger values, failing to find a good solution (see Figure 4-5).

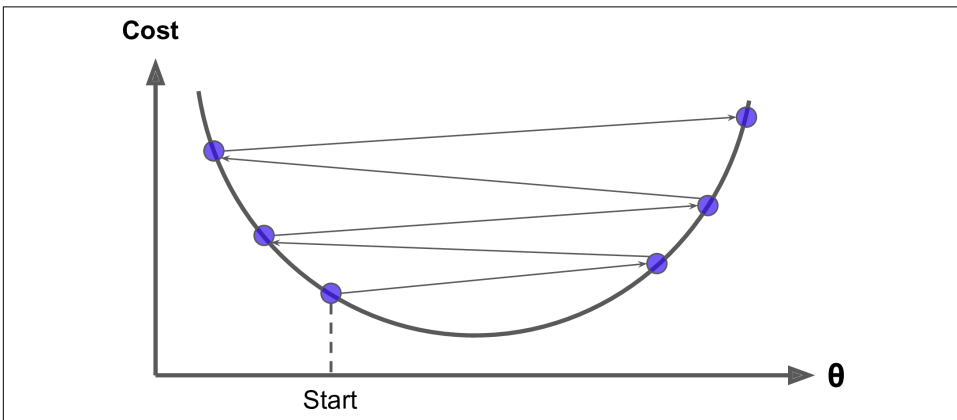

Figure 4-5. Learning rate too large

Finally, not all cost functions look like nice regular bowls. There may be holes, ridges, plateaus, and all sorts of irregular terrains, making convergence to the minimum very difficult. Figure 4-6 shows the two main challenges with Gradient Descent: if the random initialization starts the algorithm on the left, then it will converge to a *local minimum*, which is not as good as the *global minimum*. If it starts on the right, then it will take a very long time to cross the plateau, and if you stop too early you will never reach the global minimum.

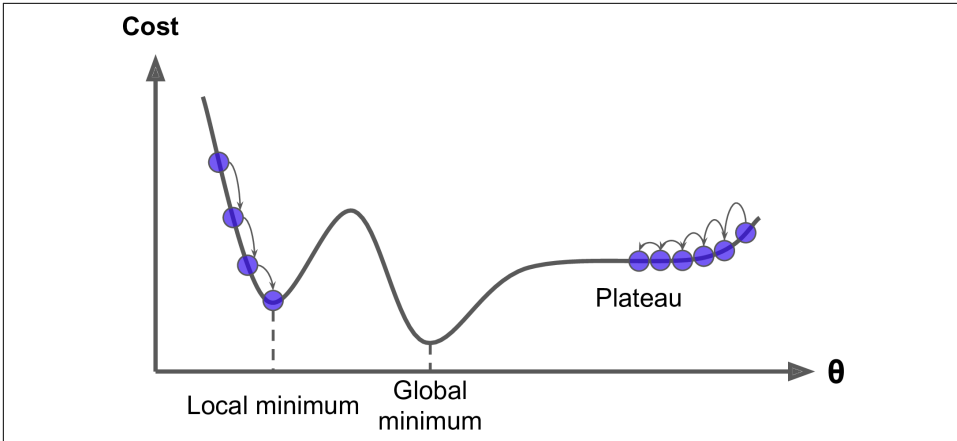

Figure 4-6. Gradient Descent pitfalls

Fortunately, the MSE cost function for a Linear Regression model happens to be a *convex function*, which means that if you pick any two points on the curve, the line segment joining them never crosses the curve. This implies that there are no local minima, just one global minimum. It is also a continuous function with a slope that never changes abruptly.⁴ These two facts have a great consequence: Gradient Descent is guaranteed to approach arbitrarily close the global minimum (if you wait long enough and if the learning rate is not too high).

In fact, the cost function has the shape of a bowl, but it can be an elongated bowl if the features have very different scales. Figure 4-7 shows Gradient Descent on a training set where features 1 and 2 have the same scale (on the left), and on a training set where feature 1 has much smaller values than feature 2 (on the right).⁵

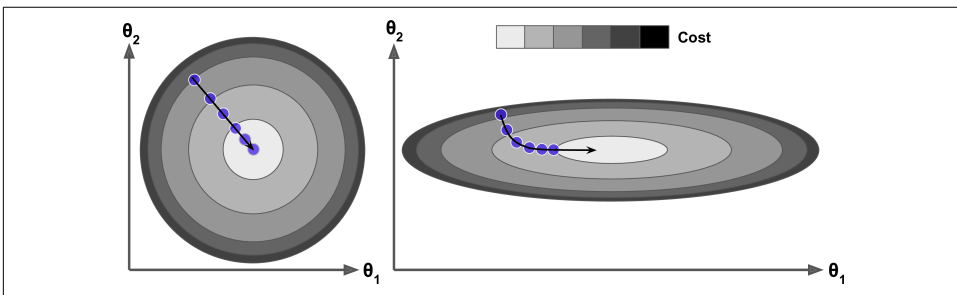

Figure 4-7. Gradient Descent with and without feature scaling

⁴ Technically speaking, its derivative is *Lipschitz continuous*.

⁵ Since feature 1 is smaller, it takes a larger change in θ_1 to affect the cost function, which is why the bowl is elongated along the θ_1 axis.

As you can see, on the left the Gradient Descent algorithm goes straight toward the minimum, thereby reaching it quickly, whereas on the right it first goes in a direction almost orthogonal to the direction of the global minimum, and it ends with a long march down an almost flat valley. It will eventually reach the minimum, but it will take a long time.



When using Gradient Descent, you should ensure that all features have a similar scale (e.g., using Scikit-Learn's `StandardScaler` class), or else it will take much longer to converge.

This diagram also illustrates the fact that training a model means searching for a combination of model parameters that minimizes a cost function (over the training set). It is a search in the model's *parameter space*: the more parameters a model has, the more dimensions this space has, and the harder the search is: searching for a needle in a 300-dimensional haystack is much trickier than in three dimensions. Fortunately, since the cost function is convex in the case of Linear Regression, the needle is simply at the bottom of the bowl.

Batch Gradient Descent

To implement Gradient Descent, you need to compute the gradient of the cost function with regards to each model parameter θ_j . In other words, you need to calculate how much the cost function will change if you change θ_j just a little bit. This is called a *partial derivative*. It is like asking “what is the slope of the mountain under my feet if I face east?” and then asking the same question facing north (and so on for all other dimensions, if you can imagine a universe with more than three dimensions). [Equation 4-5](#) computes the partial derivative of the cost function with regards to parameter θ_j , noted $\frac{\partial}{\partial \theta_j} \text{MSE}(\boldsymbol{\theta})$.

Equation 4-5. Partial derivatives of the cost function

$$\frac{\partial}{\partial \theta_j} \text{MSE}(\boldsymbol{\theta}) = \frac{2}{m} \sum_{i=1}^m (\boldsymbol{\theta}^T \mathbf{x}^{(i)} - y^{(i)}) x_j^{(i)}$$

Instead of computing these partial derivatives individually, you can use [Equation 4-6](#) to compute them all in one go. The gradient vector, noted $\nabla_{\boldsymbol{\theta}} \text{MSE}(\boldsymbol{\theta})$, contains all the partial derivatives of the cost function (one for each model parameter).

Equation 4-6. Gradient vector of the cost function

$$\nabla_{\boldsymbol{\theta}} \text{MSE}(\boldsymbol{\theta}) = \begin{pmatrix} \frac{\partial}{\partial \theta_0} \text{MSE}(\boldsymbol{\theta}) \\ \frac{\partial}{\partial \theta_1} \text{MSE}(\boldsymbol{\theta}) \\ \vdots \\ \frac{\partial}{\partial \theta_n} \text{MSE}(\boldsymbol{\theta}) \end{pmatrix} = \frac{2}{m} \mathbf{X}^T (\mathbf{X}\boldsymbol{\theta} - \mathbf{y})$$



Notice that this formula involves calculations over the full training set \mathbf{X} , at each Gradient Descent step! This is why the algorithm is called *Batch Gradient Descent*: it uses the whole batch of training data at every step (actually, *Full Gradient Descent* would probably be a better name). As a result it is terribly slow on very large training sets (but we will see much faster Gradient Descent algorithms shortly). However, Gradient Descent scales well with the number of features; training a Linear Regression model when there are hundreds of thousands of features is much faster using Gradient Descent than using the Normal Equation or SVD decomposition.

Once you have the gradient vector, which points uphill, just go in the opposite direction to go downhill. This means subtracting $\nabla_{\boldsymbol{\theta}} \text{MSE}(\boldsymbol{\theta})$ from $\boldsymbol{\theta}$. This is where the learning rate η comes into play:⁶ multiply the gradient vector by η to determine the size of the downhill step (Equation 4-7).

Equation 4-7. Gradient Descent step

$$\boldsymbol{\theta}^{(\text{next step})} = \boldsymbol{\theta} - \eta \nabla_{\boldsymbol{\theta}} \text{MSE}(\boldsymbol{\theta})$$

Let's look at a quick implementation of this algorithm:

```
eta = 0.1 # learning rate
n_iterations = 1000
m = 100

theta = np.random.randn(2,1) # random initialization

for iteration in range(n_iterations):
    gradients = 2/m * X_b.T.dot(X_b.dot(theta) - y)
    theta = theta - eta * gradients
```

⁶ Eta (η) is the 7th letter of the Greek alphabet.

That wasn't too hard! Let's look at the resulting theta:

```
>>> theta
array([[4.21509616],
       [2.77011339]])
```

Hey, that's exactly what the Normal Equation found! Gradient Descent worked perfectly. But what if you had used a different learning rate η ? Figure 4-8 shows the first 10 steps of Gradient Descent using three different learning rates (the dashed line represents the starting point).

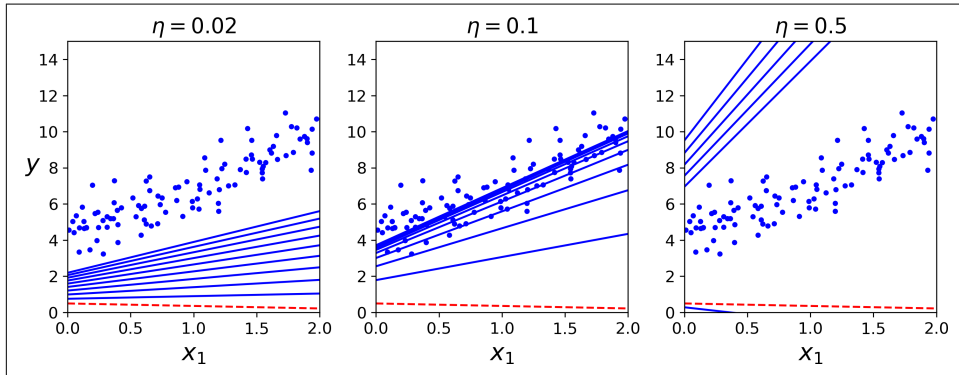

Figure 4-8. Gradient Descent with various learning rates

On the left, the learning rate is too low: the algorithm will eventually reach the solution, but it will take a long time. In the middle, the learning rate looks pretty good: in just a few iterations, it has already converged to the solution. On the right, the learning rate is too high: the algorithm diverges, jumping all over the place and actually getting further and further away from the solution at every step.

To find a good learning rate, you can use grid search (see Chapter 2). However, you may want to limit the number of iterations so that grid search can eliminate models that take too long to converge.

You may wonder how to set the number of iterations. If it is too low, you will still be far away from the optimal solution when the algorithm stops, but if it is too high, you will waste time while the model parameters do not change anymore. A simple solution is to set a very large number of iterations but to interrupt the algorithm when the gradient vector becomes tiny—that is, when its norm becomes smaller than a tiny number ϵ (called the *tolerance*)—because this happens when Gradient Descent has (almost) reached the minimum.

Convergence Rate

When the cost function is convex and its slope does not change abruptly (as is the case for the MSE cost function), Batch Gradient Descent with a fixed learning rate will eventually converge to the optimal solution, but you may have to wait a while: it can take $O(1/\epsilon)$ iterations to reach the optimum within a range of ϵ depending on the shape of the cost function. If you divide the tolerance by 10 to have a more precise solution, then the algorithm may have to run about 10 times longer.

Stochastic Gradient Descent

The main problem with Batch Gradient Descent is the fact that it uses the whole training set to compute the gradients at every step, which makes it very slow when the training set is large. At the opposite extreme, *Stochastic Gradient Descent* just picks a random instance in the training set at every step and computes the gradients based only on that single instance. Obviously this makes the algorithm much faster since it has very little data to manipulate at every iteration. It also makes it possible to train on huge training sets, since only one instance needs to be in memory at each iteration (SGD can be implemented as an out-of-core algorithm.⁷)

On the other hand, due to its stochastic (i.e., random) nature, this algorithm is much less regular than Batch Gradient Descent: instead of gently decreasing until it reaches the minimum, the cost function will bounce up and down, decreasing only on average. Over time it will end up very close to the minimum, but once it gets there it will continue to bounce around, never settling down (see [Figure 4-9](#)). So once the algorithm stops, the final parameter values are good, but not optimal.

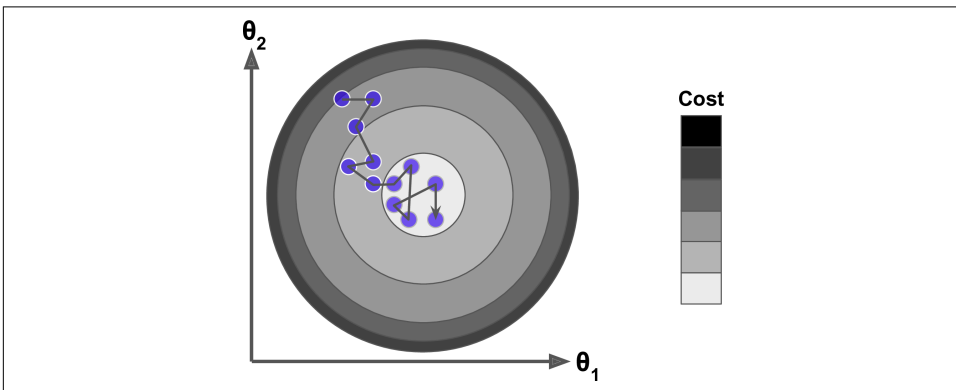

Figure 4-9. Stochastic Gradient Descent

⁷ Out-of-core algorithms are discussed in [Chapter 1](#).

When the cost function is very irregular (as in [Figure 4-6](#)), this can actually help the algorithm jump out of local minima, so Stochastic Gradient Descent has a better chance of finding the global minimum than Batch Gradient Descent does.

Therefore randomness is good to escape from local optima, but bad because it means that the algorithm can never settle at the minimum. One solution to this dilemma is to gradually reduce the learning rate. The steps start out large (which helps make quick progress and escape local minima), then get smaller and smaller, allowing the algorithm to settle at the global minimum. This process is akin to *simulated annealing*, an algorithm inspired from the process of annealing in metallurgy where molten metal is slowly cooled down. The function that determines the learning rate at each iteration is called the *learning schedule*. If the learning rate is reduced too quickly, you may get stuck in a local minimum, or even end up frozen halfway to the minimum. If the learning rate is reduced too slowly, you may jump around the minimum for a long time and end up with a suboptimal solution if you halt training too early.

This code implements Stochastic Gradient Descent using a simple learning schedule:

```
n_epochs = 50
t0, t1 = 5, 50 # learning schedule hyperparameters

def learning_schedule(t):
    return t0 / (t + t1)

theta = np.random.randn(2,1) # random initialization

for epoch in range(n_epochs):
    for i in range(m):
        random_index = np.random.randint(m)
        xi = X_b[random_index:random_index+1]
        yi = y[random_index:random_index+1]
        gradients = 2 * xi.T.dot(xi.dot(theta) - yi)
        eta = learning_schedule(epoch * m + i)
        theta = theta - eta * gradients
```

By convention we iterate by rounds of m iterations; each round is called an *epoch*. While the Batch Gradient Descent code iterated 1,000 times through the whole training set, this code goes through the training set only 50 times and reaches a fairly good solution:

```
>>> theta
array([[4.21076011],
       [2.74856079]])
```

[Figure 4-10](#) shows the first 20 steps of training (notice how irregular the steps are).

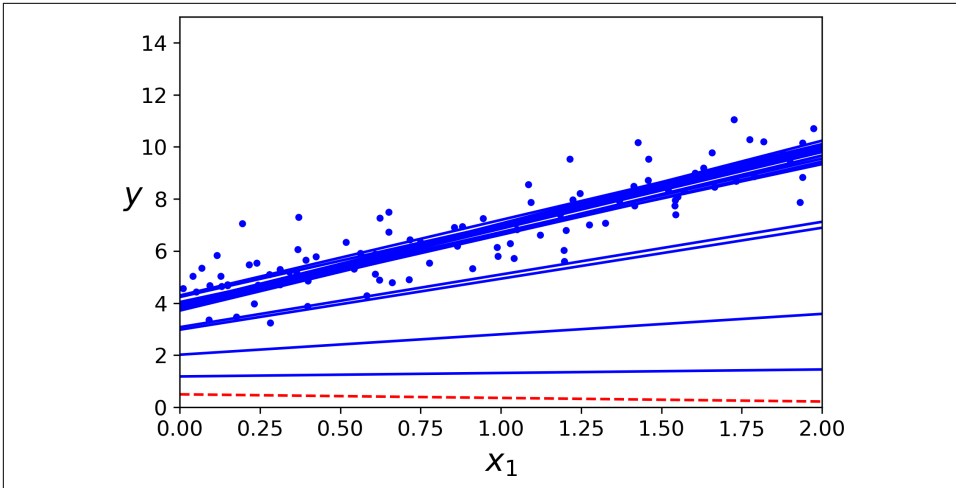

Figure 4-10. Stochastic Gradient Descent first 20 steps

Note that since instances are picked randomly, some instances may be picked several times per epoch while others may not be picked at all. If you want to be sure that the algorithm goes through every instance at each epoch, another approach is to shuffle the training set (making sure to shuffle the input features and the labels jointly), then go through it instance by instance, then shuffle it again, and so on. However, this generally converges more slowly.



When using Stochastic Gradient Descent, the training instances must be independent and identically distributed (IID), to ensure that the parameters get pulled towards the global optimum, on average. A simple way to ensure this is to shuffle the instances during training (e.g., pick each instance randomly, or shuffle the training set at the beginning of each epoch). If you do not do this, for example if the instances are sorted by label, then SGD will start by optimizing for one label, then the next, and so on, and it will not settle close to the global minimum.

To perform Linear Regression using SGD with Scikit-Learn, you can use the `SGDRegressor` class, which defaults to optimizing the squared error cost function. The following code runs for maximum 1000 epochs (`max_iter=1000`) or until the loss drops by less than $1e-3$ during one epoch (`tol=1e-3`), starting with a learning rate of 0.1 (`eta0=0.1`), using the default learning schedule (different from the preceding one), and it does not use any regularization (`penalty=None`; more details on this shortly):

```
from sklearn.linear_model import SGDRegressor
sgd_reg = SGDRegressor(max_iter=1000, tol=1e-3, penalty=None, eta0=0.1)
sgd_reg.fit(X, y.ravel())
```

Once again, you find a solution quite close to the one returned by the Normal Equation:

```
>>> sgd_reg.intercept_, sgd_reg.coef_  
(array([4.24365286]), array([2.8250878]))
```

Mini-batch Gradient Descent

The last Gradient Descent algorithm we will look at is called *Mini-batch Gradient Descent*. It is quite simple to understand once you know Batch and Stochastic Gradient Descent: at each step, instead of computing the gradients based on the full training set (as in Batch GD) or based on just one instance (as in Stochastic GD), Mini-batch GD computes the gradients on small random sets of instances called *mini-batches*. The main advantage of Mini-batch GD over Stochastic GD is that you can get a performance boost from hardware optimization of matrix operations, especially when using GPUs.

The algorithm's progress in parameter space is less erratic than with SGD, especially with fairly large mini-batches. As a result, Mini-batch GD will end up walking around a bit closer to the minimum than SGD. But, on the other hand, it may be harder for it to escape from local minima (in the case of problems that suffer from local minima, unlike Linear Regression as we saw earlier). [Figure 4-11](#) shows the paths taken by the three Gradient Descent algorithms in parameter space during training. They all end up near the minimum, but Batch GD's path actually stops at the minimum, while both Stochastic GD and Mini-batch GD continue to walk around. However, don't forget that Batch GD takes a lot of time to take each step, and Stochastic GD and Mini-batch GD would also reach the minimum if you used a good learning schedule.

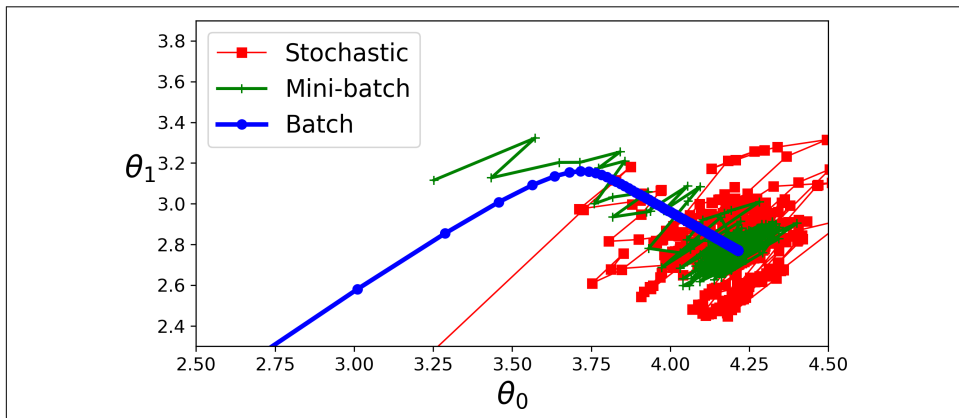

Figure 4-11. Gradient Descent paths in parameter space

Let's compare the algorithms we've discussed so far for Linear Regression⁸ (recall that m is the number of training instances and n is the number of features); see [Table 4-1](#).

Table 4-1. Comparison of algorithms for Linear Regression

Algorithm	Large m	Out-of-core support	Large n	Hyperparams	Scaling required	Scikit-Learn
Normal Equation	Fast	No	Slow	0	No	n/a
SVD	Fast	No	Slow	0	No	LinearRegression
Batch GD	Slow	No	Fast	2	Yes	SGDRegressor
Stochastic GD	Fast	Yes	Fast	≥ 2	Yes	SGDRegressor
Mini-batch GD	Fast	Yes	Fast	≥ 2	Yes	SGDRegressor



There is almost no difference after training: all these algorithms end up with very similar models and make predictions in exactly the same way.

Polynomial Regression

What if your data is actually more complex than a simple straight line? Surprisingly, you can actually use a linear model to fit nonlinear data. A simple way to do this is to add powers of each feature as new features, then train a linear model on this extended set of features. This technique is called *Polynomial Regression*.

Let's look at an example. First, let's generate some nonlinear data, based on a simple *quadratic equation*⁹ (plus some noise; see [Figure 4-12](#)):

```
m = 100
X = 6 * np.random.rand(m, 1) - 3
y = 0.5 * X**2 + X + 2 + np.random.randn(m, 1)
```

⁸ While the Normal Equation can only perform Linear Regression, the Gradient Descent algorithms can be used to train many other models, as we will see.

⁹ A quadratic equation is of the form $y = ax^2 + bx + c$.

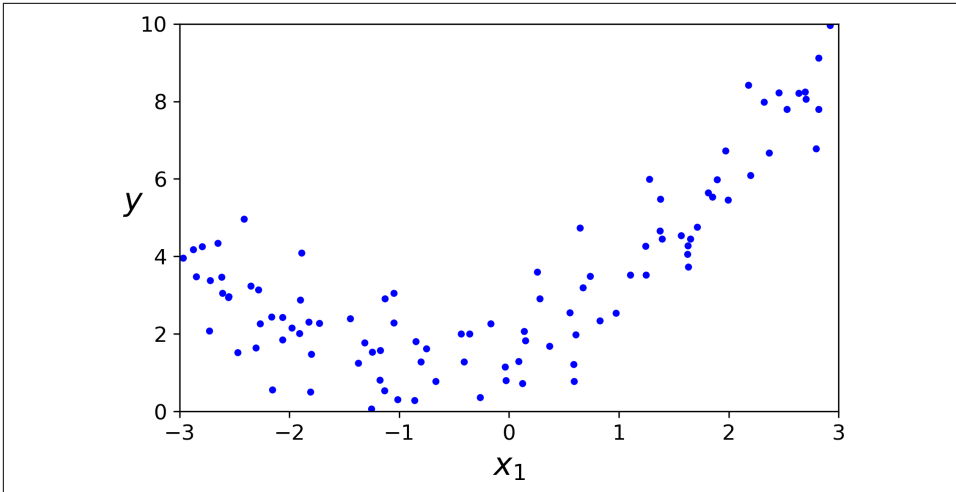

Figure 4-12. Generated nonlinear and noisy dataset

Clearly, a straight line will never fit this data properly. So let's use Scikit-Learn's `PolynomialFeatures` class to transform our training data, adding the square (2nd-degree polynomial) of each feature in the training set as new features (in this case there is just one feature):

```
>>> from sklearn.preprocessing import PolynomialFeatures
>>> poly_features = PolynomialFeatures(degree=2, include_bias=False)
>>> X_poly = poly_features.fit_transform(X)
>>> X[0]
array([-0.75275929])
>>> X_poly[0]
array([-0.75275929, 0.56664654])
```

`X_poly` now contains the original feature of `X` plus the square of this feature. Now you can fit a `LinearRegression` model to this extended training data (Figure 4-13):

```
>>> lin_reg = LinearRegression()
>>> lin_reg.fit(X_poly, y)
>>> lin_reg.intercept_, lin_reg.coef_
(array([1.78134581]), array([[0.93366893, 0.56456263]]))
```

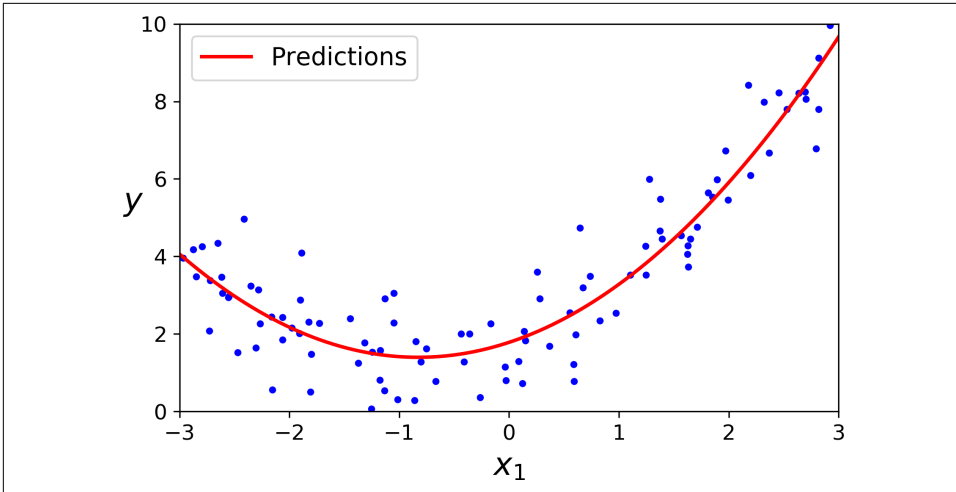

Figure 4-13. Polynomial Regression model predictions

Not bad: the model estimates $\hat{y} = 0.56x_1^2 + 0.93x_1 + 1.78$ when in fact the original function was $y = 0.5x_1^2 + 1.0x_1 + 2.0 + \text{Gaussian noise}$.

Note that when there are multiple features, Polynomial Regression is capable of finding relationships between features (which is something a plain Linear Regression model cannot do). This is made possible by the fact that `PolynomialFeatures` also adds all combinations of features up to the given degree. For example, if there were two features a and b , `PolynomialFeatures` with `degree=3` would not only add the features a^2 , a^3 , b^2 , and b^3 , but also the combinations ab , a^2b , and ab^2 .



`PolynomialFeatures(degree=d)` transforms an array containing n features into an array containing $\frac{(n+d)!}{d!n!}$ features, where $n!$ is the factorial of n , equal to $1 \times 2 \times 3 \times \dots \times n$. Beware of the combinatorial explosion of the number of features!

Learning Curves

If you perform high-degree Polynomial Regression, you will likely fit the training data much better than with plain Linear Regression. For example, [Figure 4-14](#) applies a 300-degree polynomial model to the preceding training data, and compares the result with a pure linear model and a quadratic model (2nd-degree polynomial). Notice how the 300-degree polynomial model wiggles around to get as close as possible to the training instances.

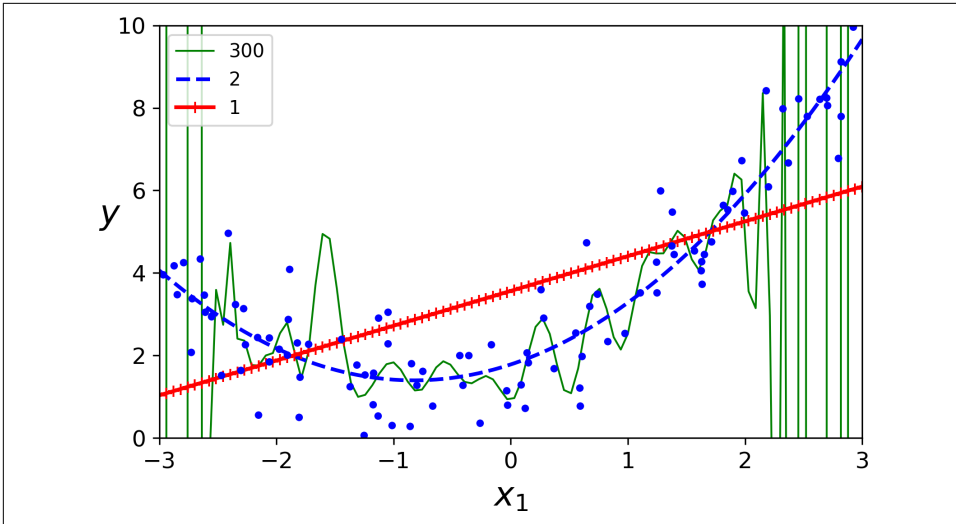

Figure 4-14. High-degree Polynomial Regression

Of course, this high-degree Polynomial Regression model is severely overfitting the training data, while the linear model is underfitting it. The model that will generalize best in this case is the quadratic model. It makes sense since the data was generated using a quadratic model, but in general you won't know what function generated the data, so how can you decide how complex your model should be? How can you tell that your model is overfitting or underfitting the data?

In [Chapter 2](#) you used cross-validation to get an estimate of a model's generalization performance. If a model performs well on the training data but generalizes poorly according to the cross-validation metrics, then your model is overfitting. If it performs poorly on both, then it is underfitting. This is one way to tell when a model is too simple or too complex.

Another way is to look at the *learning curves*: these are plots of the model's performance on the training set and the validation set as a function of the training set size (or the training iteration). To generate the plots, simply train the model several times on different sized subsets of the training set. The following code defines a function that plots the learning curves of a model given some training data:

```
from sklearn.metrics import mean_squared_error
from sklearn.model_selection import train_test_split

def plot_learning_curves(model, X, y):
    X_train, X_val, y_train, y_val = train_test_split(X, y, test_size=0.2)
    train_errors, val_errors = [], []
    for m in range(1, len(X_train)):
        model.fit(X_train[:m], y_train[:m])
        y_train_predict = model.predict(X_train[:m])
```

```

y_val_predict = model.predict(X_val)
train_errors.append(mean_squared_error(y_train[:m], y_train_predict))
val_errors.append(mean_squared_error(y_val, y_val_predict))
plt.plot(np.sqrt(train_errors), "r-+", linewidth=2, label="train")
plt.plot(np.sqrt(val_errors), "b-", linewidth=3, label="val")

```

Let's look at the learning curves of the plain Linear Regression model (a straight line; [Figure 4-15](#)):

```

lin_reg = LinearRegression()
plot_learning_curves(lin_reg, X, y)

```

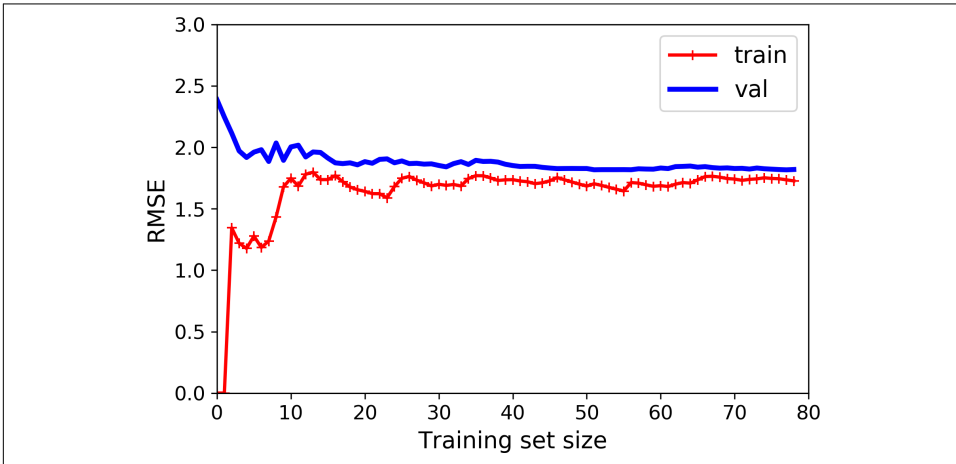

Figure 4-15. Learning curves

This deserves a bit of explanation. First, let's look at the performance on the training data: when there are just one or two instances in the training set, the model can fit them perfectly, which is why the curve starts at zero. But as new instances are added to the training set, it becomes impossible for the model to fit the training data perfectly, both because the data is noisy and because it is not linear at all. So the error on the training data goes up until it reaches a plateau, at which point adding new instances to the training set doesn't make the average error much better or worse. Now let's look at the performance of the model on the validation data. When the model is trained on very few training instances, it is incapable of generalizing properly, which is why the validation error is initially quite big. Then as the model is shown more training examples, it learns and thus the validation error slowly goes down. However, once again a straight line cannot do a good job modeling the data, so the error ends up at a plateau, very close to the other curve.

These learning curves are typical of an underfitting model. Both curves have reached a plateau; they are close and fairly high.



If your model is underfitting the training data, adding more training examples will not help. You need to use a more complex model or come up with better features.

Now let's look at the learning curves of a 10th-degree polynomial model on the same data (Figure 4-16):

```
from sklearn.pipeline import Pipeline

polynomial_regression = Pipeline([
    ("poly_features", PolynomialFeatures(degree=10, include_bias=False)),
    ("lin_reg", LinearRegression()),
])

plot_learning_curves(polynomial_regression, X, y)
```

These learning curves look a bit like the previous ones, but there are two very important differences:

- The error on the training data is much lower than with the Linear Regression model.
- There is a gap between the curves. This means that the model performs significantly better on the training data than on the validation data, which is the hallmark of an overfitting model. However, if you used a much larger training set, the two curves would continue to get closer.

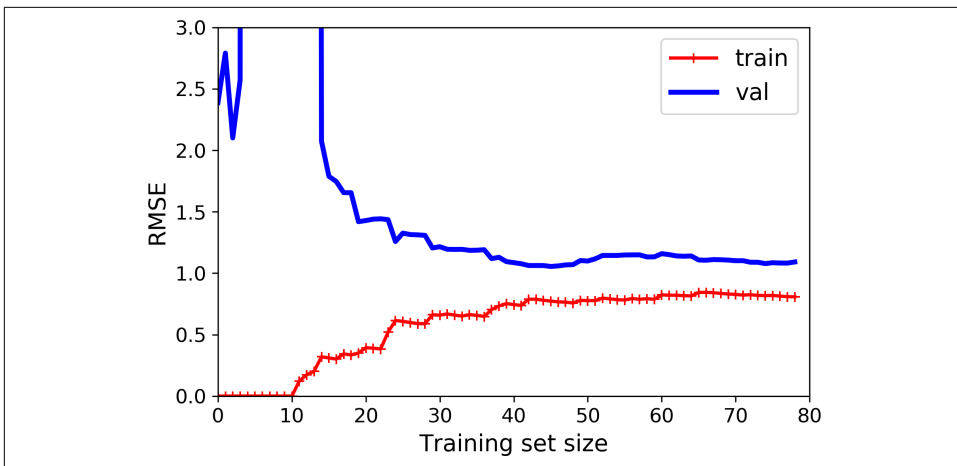

Figure 4-16. Learning curves for the polynomial model



One way to improve an overfitting model is to feed it more training data until the validation error reaches the training error.

The Bias/Variance Tradeoff

An important theoretical result of statistics and Machine Learning is the fact that a model's generalization error can be expressed as the sum of three very different errors:

Bias

This part of the generalization error is due to wrong assumptions, such as assuming that the data is linear when it is actually quadratic. A high-bias model is most likely to underfit the training data.¹⁰

Variance

This part is due to the model's excessive sensitivity to small variations in the training data. A model with many degrees of freedom (such as a high-degree polynomial model) is likely to have high variance, and thus to overfit the training data.

Irreducible error

This part is due to the noisiness of the data itself. The only way to reduce this part of the error is to clean up the data (e.g., fix the data sources, such as broken sensors, or detect and remove outliers).

Increasing a model's complexity will typically increase its variance and reduce its bias. Conversely, reducing a model's complexity increases its bias and reduces its variance. This is why it is called a tradeoff.

Regularized Linear Models

As we saw in Chapters 1 and 2, a good way to reduce overfitting is to regularize the model (i.e., to constrain it): the fewer degrees of freedom it has, the harder it will be for it to overfit the data. For example, a simple way to regularize a polynomial model is to reduce the number of polynomial degrees.

For a linear model, regularization is typically achieved by constraining the weights of the model. We will now look at Ridge Regression, Lasso Regression, and Elastic Net, which implement three different ways to constrain the weights.

¹⁰ This notion of bias is not to be confused with the bias term of linear models.

Ridge Regression

Ridge Regression (also called *Tikhonov regularization*) is a regularized version of Linear Regression: a *regularization term* equal to $\alpha \sum_{i=1}^n \theta_i^2$ is added to the cost function. This forces the learning algorithm to not only fit the data but also keep the model weights as small as possible. Note that the regularization term should only be added to the cost function during training. Once the model is trained, you want to evaluate the model's performance using the unregularized performance measure.



It is quite common for the cost function used during training to be different from the performance measure used for testing. Apart from regularization, another reason why they might be different is that a good training cost function should have optimization-friendly derivatives, while the performance measure used for testing should be as close as possible to the final objective. A good example of this is a classifier trained using a cost function such as the log loss (discussed in a moment) but evaluated using precision/recall.

The hyperparameter α controls how much you want to regularize the model. If $\alpha = 0$ then Ridge Regression is just Linear Regression. If α is very large, then all weights end up very close to zero and the result is a flat line going through the data's mean. [Equation 4-8](#) presents the Ridge Regression cost function.¹¹

Equation 4-8. Ridge Regression cost function

$$J(\boldsymbol{\theta}) = \text{MSE}(\boldsymbol{\theta}) + \alpha \frac{1}{2} \sum_{i=1}^n \theta_i^2$$

Note that the bias term θ_0 is not regularized (the sum starts at $i = 1$, not 0). If we define \mathbf{w} as the vector of feature weights (θ_1 to θ_n), then the regularization term is simply equal to $\frac{1}{2}(\|\mathbf{w}\|_2)^2$, where $\|\mathbf{w}\|_2$ represents the ℓ_2 norm of the weight vector.¹² For Gradient Descent, just add $\alpha \mathbf{w}$ to the MSE gradient vector ([Equation 4-6](#)).



It is important to scale the data (e.g., using a `StandardScaler`) before performing Ridge Regression, as it is sensitive to the scale of the input features. This is true of most regularized models.

¹¹ It is common to use the notation $J(\boldsymbol{\theta})$ for cost functions that don't have a short name; we will often use this notation throughout the rest of this book. The context will make it clear which cost function is being discussed.

¹² Norms are discussed in [Chapter 2](#).

Figure 4-17 shows several Ridge models trained on some linear data using different α value. On the left, plain Ridge models are used, leading to linear predictions. On the right, the data is first expanded using `PolynomialFeatures(degree=10)`, then it is scaled using a `StandardScaler`, and finally the Ridge models are applied to the resulting features: this is Polynomial Regression with Ridge regularization. Note how increasing α leads to flatter (i.e., less extreme, more reasonable) predictions; this reduces the model's variance but increases its bias.

As with Linear Regression, we can perform Ridge Regression either by computing a closed-form equation or by performing Gradient Descent. The pros and cons are the same. Equation 4-9 shows the closed-form solution (where \mathbf{A} is the $(n + 1) \times (n + 1)$ identity matrix¹³ except with a 0 in the top-left cell, corresponding to the bias term).

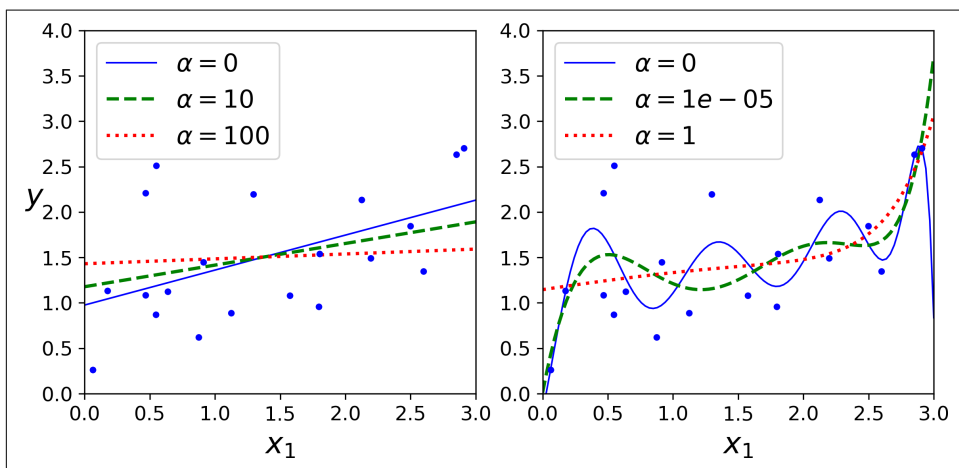

Figure 4-17. Ridge Regression

Equation 4-9. Ridge Regression closed-form solution

$$\hat{\theta} = (\mathbf{X}^T \mathbf{X} + \alpha \mathbf{A})^{-1} \mathbf{X}^T \mathbf{y}$$

Here is how to perform Ridge Regression with Scikit-Learn using a closed-form solution (a variant of Equation 4-9 using a matrix factorization technique by André-Louis Cholesky):

```
>>> from sklearn.linear_model import Ridge
>>> ridge_reg = Ridge(alpha=1, solver="cholesky")
>>> ridge_reg.fit(X, y)
```

¹³ A square matrix full of 0s except for 1s on the main diagonal (top-left to bottom-right).

```
>>> ridge_reg.predict([[1.5]])
array([[1.55071465]])
```

And using Stochastic Gradient Descent:¹⁴

```
>>> sgd_reg = SGDRegressor(penalty="l2")
>>> sgd_reg.fit(X, y.ravel())
>>> sgd_reg.predict([[1.5]])
array([1.47012588])
```

The penalty hyperparameter sets the type of regularization term to use. Specifying "l2" indicates that you want SGD to add a regularization term to the cost function equal to half the square of the ℓ_2 norm of the weight vector: this is simply Ridge Regression.

Lasso Regression

Least Absolute Shrinkage and Selection Operator Regression (simply called *Lasso Regression*) is another regularized version of Linear Regression: just like Ridge Regression, it adds a regularization term to the cost function, but it uses the ℓ_1 norm of the weight vector instead of half the square of the ℓ_2 norm (see [Equation 4-10](#)).

Equation 4-10. Lasso Regression cost function

$$J(\boldsymbol{\theta}) = \text{MSE}(\boldsymbol{\theta}) + \alpha \sum_{i=1}^n |\theta_i|$$

[Figure 4-18](#) shows the same thing as [Figure 4-17](#) but replaces Ridge models with Lasso models and uses smaller α values.

¹⁴ Alternatively you can use the `Ridge` class with the "sag" solver. Stochastic Average GD is a variant of SGD. For more details, see the presentation "[Minimizing Finite Sums with the Stochastic Average Gradient Algorithm](#)" by Mark Schmidt et al. from the University of British Columbia.

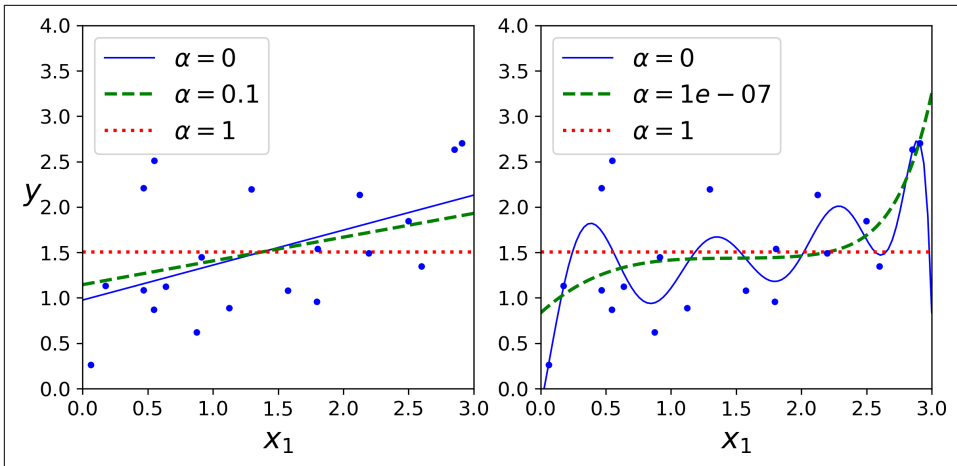

Figure 4-18. Lasso Regression

An important characteristic of Lasso Regression is that it tends to completely eliminate the weights of the least important features (i.e., set them to zero). For example, the dashed line in the right plot on [Figure 4-18](#) (with $\alpha = 10^{-7}$) looks quadratic, almost linear: all the weights for the high-degree polynomial features are equal to zero. In other words, Lasso Regression automatically performs feature selection and outputs a *sparse model* (i.e., with few nonzero feature weights).

You can get a sense of why this is the case by looking at [Figure 4-19](#): on the top-left plot, the background contours (ellipses) represent an unregularized MSE cost function ($\alpha = 0$), and the white circles show the Batch Gradient Descent path with that cost function. The foreground contours (diamonds) represent the ℓ_1 penalty, and the triangles show the BGD path for this penalty only ($\alpha \rightarrow \infty$). Notice how the path first reaches $\theta_1 = 0$, then rolls down a gutter until it reaches $\theta_2 = 0$. On the top-right plot, the contours represent the same cost function plus an ℓ_1 penalty with $\alpha = 0.5$. The global minimum is on the $\theta_2 = 0$ axis. BGD first reaches $\theta_2 = 0$, then rolls down the gutter until it reaches the global minimum. The two bottom plots show the same thing but uses an ℓ_2 penalty instead. The regularized minimum is closer to $\theta = \mathbf{0}$ than the unregularized minimum, but the weights do not get fully eliminated.

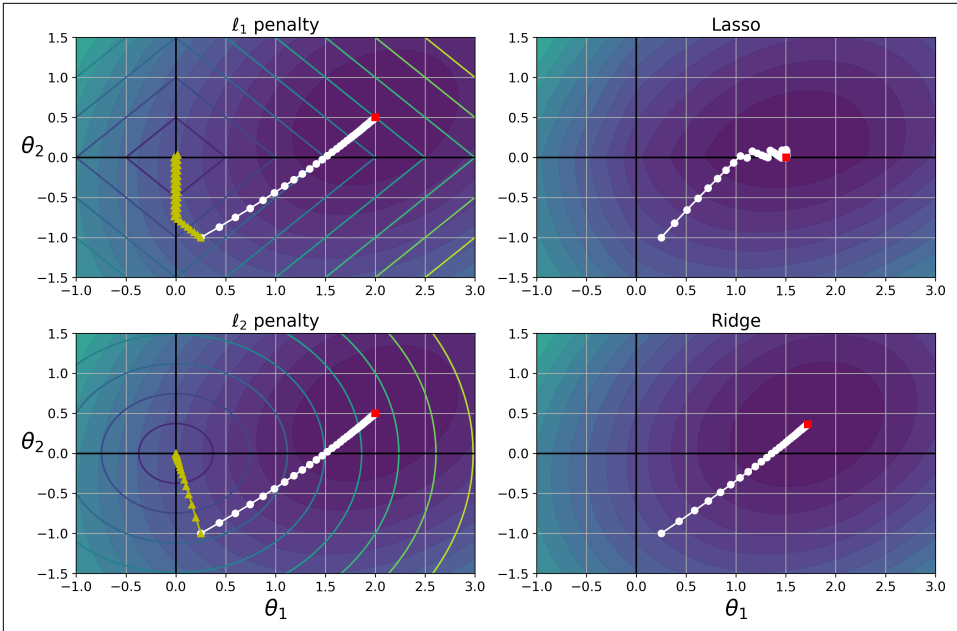

Figure 4-19. Lasso versus Ridge regularization



On the Lasso cost function, the BGD path tends to bounce across the gutter toward the end. This is because the slope changes abruptly at $\theta_2 = 0$. You need to gradually reduce the learning rate in order to actually converge to the global minimum.

The Lasso cost function is not differentiable at $\theta_i = 0$ (for $i = 1, 2, \dots, n$), but Gradient Descent still works fine if you use a *subgradient vector* \mathbf{g} ¹⁵ instead when any $\theta_i = 0$. Equation 4-11 shows a subgradient vector equation you can use for Gradient Descent with the Lasso cost function.

Equation 4-11. Lasso Regression subgradient vector

$$g(\boldsymbol{\theta}, J) = \nabla_{\boldsymbol{\theta}} \text{MSE}(\boldsymbol{\theta}) + \alpha \begin{pmatrix} \text{sign}(\theta_1) \\ \text{sign}(\theta_2) \\ \vdots \\ \text{sign}(\theta_n) \end{pmatrix} \quad \text{where } \text{sign}(\theta_i) = \begin{cases} -1 & \text{if } \theta_i < 0 \\ 0 & \text{if } \theta_i = 0 \\ +1 & \text{if } \theta_i > 0 \end{cases}$$

15 You can think of a subgradient vector at a nondifferentiable point as an intermediate vector between the gradient vectors around that point.

Here is a small Scikit-Learn example using the Lasso class. Note that you could instead use an SGDRegressor(penalty="l1").

```
>>> from sklearn.linear_model import Lasso
>>> lasso_reg = Lasso(alpha=0.1)
>>> lasso_reg.fit(X, y)
>>> lasso_reg.predict([[1.5]])
array([1.53788174])
```

Elastic Net

Elastic Net is a middle ground between Ridge Regression and Lasso Regression. The regularization term is a simple mix of both Ridge and Lasso's regularization terms, and you can control the mix ratio r . When $r = 0$, Elastic Net is equivalent to Ridge Regression, and when $r = 1$, it is equivalent to Lasso Regression (see [Equation 4-12](#)).

Equation 4-12. Elastic Net cost function

$$J(\boldsymbol{\theta}) = \text{MSE}(\boldsymbol{\theta}) + r\alpha\sum_{i=1}^n |\theta_i| + \frac{1-r}{2}\alpha\sum_{i=1}^n \theta_i^2$$

So when should you use plain Linear Regression (i.e., without any regularization), Ridge, Lasso, or Elastic Net? It is almost always preferable to have at least a little bit of regularization, so generally you should avoid plain Linear Regression. Ridge is a good default, but if you suspect that only a few features are actually useful, you should prefer Lasso or Elastic Net since they tend to reduce the useless features' weights down to zero as we have discussed. In general, Elastic Net is preferred over Lasso since Lasso may behave erratically when the number of features is greater than the number of training instances or when several features are strongly correlated.

Here is a short example using Scikit-Learn's ElasticNet (l1_ratio corresponds to the mix ratio r):

```
>>> from sklearn.linear_model import ElasticNet
>>> elastic_net = ElasticNet(alpha=0.1, l1_ratio=0.5)
>>> elastic_net.fit(X, y)
>>> elastic_net.predict([[1.5]])
array([1.54333232])
```

Early Stopping

A very different way to regularize iterative learning algorithms such as Gradient Descent is to stop training as soon as the validation error reaches a minimum. This is called *early stopping*. [Figure 4-20](#) shows a complex model (in this case a high-degree Polynomial Regression model) being trained using Batch Gradient Descent. As the epochs go by, the algorithm learns and its prediction error (RMSE) on the training set naturally goes down, and so does its prediction error on the validation set. However,

after a while the validation error stops decreasing and actually starts to go back up. This indicates that the model has started to overfit the training data. With early stopping you just stop training as soon as the validation error reaches the minimum. It is such a simple and efficient regularization technique that Geoffrey Hinton called it a “beautiful free lunch.”

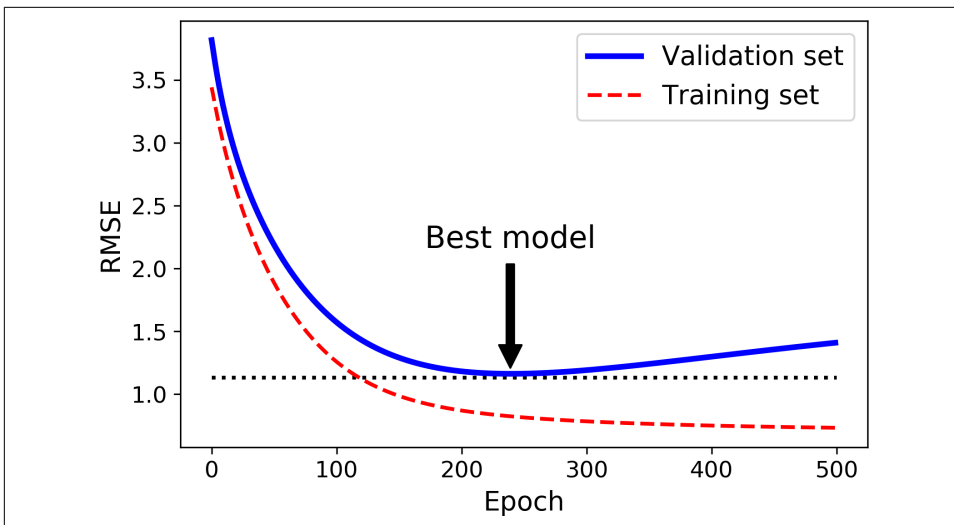

Figure 4-20. Early stopping regularization



With Stochastic and Mini-batch Gradient Descent, the curves are not so smooth, and it may be hard to know whether you have reached the minimum or not. One solution is to stop only after the validation error has been above the minimum for some time (when you are confident that the model will not do any better), then roll back the model parameters to the point where the validation error was at a minimum.

Here is a basic implementation of early stopping:

```
from sklearn.base import clone

# prepare the data
poly_scaler = Pipeline([
    ("poly_features", PolynomialFeatures(degree=90, include_bias=False)),
    ("std_scaler", StandardScaler())
])
X_train_poly_scaled = poly_scaler.fit_transform(X_train)
X_val_poly_scaled = poly_scaler.transform(X_val)

sgd_reg = SGDRegressor(max_iter=1, tol=-np.infty, warm_start=True,
                       penalty=None, learning_rate="constant", eta0=0.0005)
```

```

minimum_val_error = float("inf")
best_epoch = None
best_model = None
for epoch in range(1000):
    sgd_reg.fit(X_train_poly_scaled, y_train) # continues where it left off
    y_val_predict = sgd_reg.predict(X_val_poly_scaled)
    val_error = mean_squared_error(y_val, y_val_predict)
    if val_error < minimum_val_error:
        minimum_val_error = val_error
        best_epoch = epoch
        best_model = clone(sgd_reg)

```

Note that with `warm_start=True`, when the `fit()` method is called, it just continues training where it left off instead of restarting from scratch.

Logistic Regression

As we discussed in [Chapter 1](#), some regression algorithms can be used for classification as well (and vice versa). *Logistic Regression* (also called *Logit Regression*) is commonly used to estimate the probability that an instance belongs to a particular class (e.g., what is the probability that this email is spam?). If the estimated probability is greater than 50%, then the model predicts that the instance belongs to that class (called the positive class, labeled “1”), or else it predicts that it does not (i.e., it belongs to the negative class, labeled “0”). This makes it a binary classifier.

Estimating Probabilities

So how does it work? Just like a Linear Regression model, a Logistic Regression model computes a weighted sum of the input features (plus a bias term), but instead of outputting the result directly like the Linear Regression model does, it outputs the *logistic* of this result (see [Equation 4-13](#)).

Equation 4-13. Logistic Regression model estimated probability (vectorized form)

$$\hat{p} = h_{\theta}(\mathbf{x}) = \sigma(\mathbf{x}^T \boldsymbol{\theta})$$

The logistic—noted $\sigma(\cdot)$ —is a *sigmoid function* (i.e., S-shaped) that outputs a number between 0 and 1. It is defined as shown in [Equation 4-14](#) and [Figure 4-21](#).

Equation 4-14. Logistic function

$$\sigma(t) = \frac{1}{1 + \exp(-t)}$$

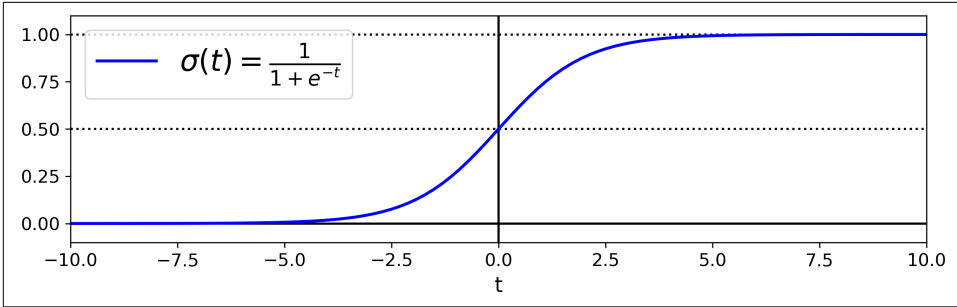

Figure 4-21. Logistic function

Once the Logistic Regression model has estimated the probability $\hat{p} = h_{\theta}(\mathbf{x})$ that an instance \mathbf{x} belongs to the positive class, it can make its prediction \hat{y} easily (see Equation 4-15).

Equation 4-15. Logistic Regression model prediction

$$\hat{y} = \begin{cases} 0 & \text{if } \hat{p} < 0.5 \\ 1 & \text{if } \hat{p} \geq 0.5 \end{cases}$$

Notice that $\sigma(t) < 0.5$ when $t < 0$, and $\sigma(t) \geq 0.5$ when $t \geq 0$, so a Logistic Regression model predicts 1 if $\mathbf{x}^T \boldsymbol{\theta}$ is positive, and 0 if it is negative.



The score t is often called the *logit*: this name comes from the fact that the logit function, defined as $\text{logit}(p) = \log(p / (1 - p))$, is the inverse of the logistic function. Indeed, if you compute the logit of the estimated probability p , you will find that the result is t . The logit is also called the *log-odds*, since it is the log of the ratio between the estimated probability for the positive class and the estimated probability for the negative class.

Training and Cost Function

Good, now you know how a Logistic Regression model estimates probabilities and makes predictions. But how is it trained? The objective of training is to set the parameter vector $\boldsymbol{\theta}$ so that the model estimates high probabilities for positive instances ($y = 1$) and low probabilities for negative instances ($y = 0$). This idea is captured by the cost function shown in Equation 4-16 for a single training instance \mathbf{x} .

Equation 4-16. Cost function of a single training instance

$$c(\boldsymbol{\theta}) = \begin{cases} -\log(\hat{p}) & \text{if } y = 1 \\ -\log(1 - \hat{p}) & \text{if } y = 0 \end{cases}$$

This cost function makes sense because $-\log(t)$ grows very large when t approaches 0, so the cost will be large if the model estimates a probability close to 0 for a positive instance, and it will also be very large if the model estimates a probability close to 1 for a negative instance. On the other hand, $-\log(t)$ is close to 0 when t is close to 1, so the cost will be close to 0 if the estimated probability is close to 0 for a negative instance or close to 1 for a positive instance, which is precisely what we want.

The cost function over the whole training set is simply the average cost over all training instances. It can be written in a single expression (as you can verify easily), called the *log loss*, shown in [Equation 4-17](#).

Equation 4-17. Logistic Regression cost function (log loss)

$$J(\boldsymbol{\theta}) = -\frac{1}{m} \sum_{i=1}^m \left[y^{(i)} \log(\hat{p}^{(i)}) + (1 - y^{(i)}) \log(1 - \hat{p}^{(i)}) \right]$$

The bad news is that there is no known closed-form equation to compute the value of $\boldsymbol{\theta}$ that minimizes this cost function (there is no equivalent of the Normal Equation). But the good news is that this cost function is convex, so Gradient Descent (or any other optimization algorithm) is guaranteed to find the global minimum (if the learning rate is not too large and you wait long enough). The partial derivatives of the cost function with regards to the j^{th} model parameter θ_j is given by [Equation 4-18](#).

Equation 4-18. Logistic cost function partial derivatives

$$\frac{\partial}{\partial \theta_j} J(\boldsymbol{\theta}) = \frac{1}{m} \sum_{i=1}^m \left(\sigma(\boldsymbol{\theta}^T \mathbf{x}^{(i)}) - y^{(i)} \right) x_j^{(i)}$$

This equation looks very much like [Equation 4-5](#): for each instance it computes the prediction error and multiplies it by the j^{th} feature value, and then it computes the average over all training instances. Once you have the gradient vector containing all the partial derivatives you can use it in the Batch Gradient Descent algorithm. That's it: you now know how to train a Logistic Regression model. For Stochastic GD you would of course just take one instance at a time, and for Mini-batch GD you would use a mini-batch at a time.

Decision Boundaries

Let's use the iris dataset to illustrate Logistic Regression. This is a famous dataset that contains the sepal and petal length and width of 150 iris flowers of three different species: Iris-Setosa, Iris-Versicolor, and Iris-Virginica (see [Figure 4-22](#)).

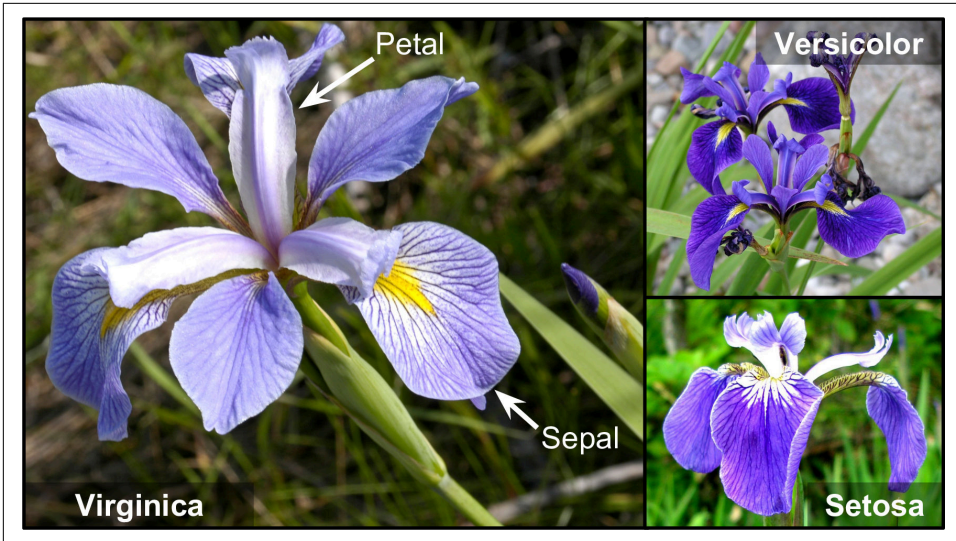

Figure 4-22. Flowers of three iris plant species¹⁶

Let's try to build a classifier to detect the Iris-Virginica type based only on the petal width feature. First let's load the data:

```
>>> from sklearn import datasets
>>> iris = datasets.load_iris()
>>> list(iris.keys())
['data', 'target', 'target_names', 'DESCR', 'feature_names', 'filename']
>>> X = iris["data"][:, 3:] # petal width
>>> y = (iris["target"] == 2).astype(np.int) # 1 if Iris-Virginica, else 0
```

Now let's train a Logistic Regression model:

```
from sklearn.linear_model import LogisticRegression

log_reg = LogisticRegression()
log_reg.fit(X, y)
```

Let's look at the model's estimated probabilities for flowers with petal widths varying from 0 to 3 cm (Figure 4-23)¹⁷:

```
X_new = np.linspace(0, 3, 1000).reshape(-1, 1)
y_proba = log_reg.predict_proba(X_new)
plt.plot(X_new, y_proba[:, 1], "g-", label="Iris-Virginica")
```

16 Photos reproduced from the corresponding Wikipedia pages. Iris-Virginica photo by Frank Mayfield (Creative Commons BY-SA 2.0), Iris-Versicolor photo by D. Gordon E. Robertson (Creative Commons BY-SA 3.0), and Iris-Setosa photo is public domain.

17 NumPy's reshape() function allows one dimension to be -1, which means "unspecified": the value is inferred from the length of the array and the remaining dimensions.

```
plt.plot(X_new, y_proba[:, 0], "b--", label="Not Iris-Virginica")
# + more Matplotlib code to make the image look pretty
```

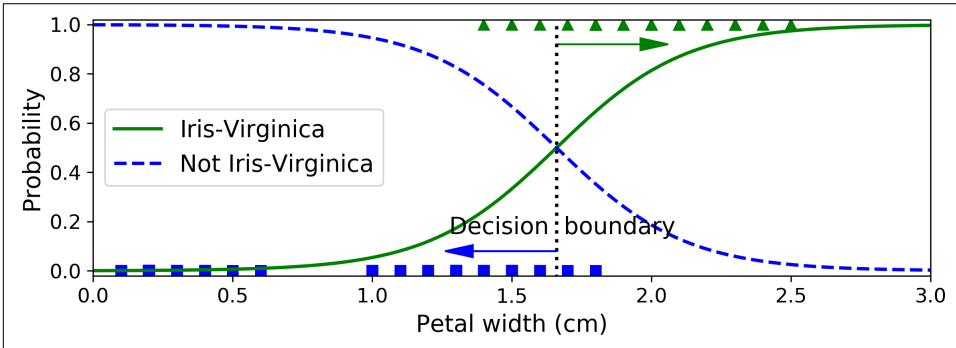

Figure 4-23. Estimated probabilities and decision boundary

The petal width of Iris-Virginica flowers (represented by triangles) ranges from 1.4 cm to 2.5 cm, while the other iris flowers (represented by squares) generally have a smaller petal width, ranging from 0.1 cm to 1.8 cm. Notice that there is a bit of overlap. Above about 2 cm the classifier is highly confident that the flower is an Iris-Virginica (it outputs a high probability to that class), while below 1 cm it is highly confident that it is not an Iris-Virginica (high probability for the “Not Iris-Virginica” class). In between these extremes, the classifier is unsure. However, if you ask it to predict the class (using the `predict()` method rather than the `predict_proba()` method), it will return whichever class is the most likely. Therefore, there is a *decision boundary* at around 1.6 cm where both probabilities are equal to 50%: if the petal width is higher than 1.6 cm, the classifier will predict that the flower is an Iris-Virginica, or else it will predict that it is not (even if it is not very confident):

```
>>> log_reg.predict([[1.7], [1.5]])
array([1, 0])
```

Figure 4-24 shows the same dataset but this time displaying two features: petal width and length. Once trained, the Logistic Regression classifier can estimate the probability that a new flower is an Iris-Virginica based on these two features. The dashed line represents the points where the model estimates a 50% probability: this is the model’s decision boundary. Note that it is a linear boundary.¹⁸ Each parallel line represents the points where the model outputs a specific probability, from 15% (bottom left) to 90% (top right). All the flowers beyond the top-right line have an over 90% chance of being Iris-Virginica according to the model.

¹⁸ It is the the set of points \mathbf{x} such that $\theta_0 + \theta_1 x_1 + \theta_2 x_2 = 0$, which defines a straight line.

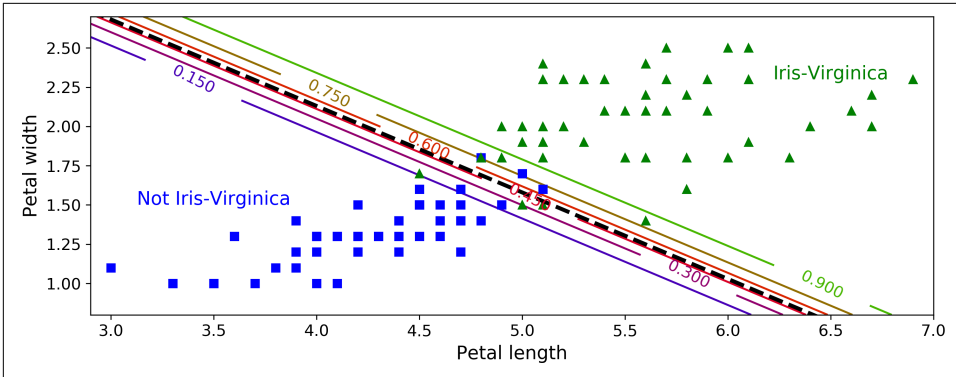

Figure 4-24. Linear decision boundary

Just like the other linear models, Logistic Regression models can be regularized using ℓ_1 or ℓ_2 penalties. Scikit-Learn actually adds an ℓ_2 penalty by default.



The hyperparameter controlling the regularization strength of a Scikit-Learn `LogisticRegression` model is not α (as in other linear models), but its inverse: C . The higher the value of C , the less the model is regularized.

Softmax Regression

The Logistic Regression model can be generalized to support multiple classes directly, without having to train and combine multiple binary classifiers (as discussed in [Chapter 3](#)). This is called *Softmax Regression*, or *Multinomial Logistic Regression*.

The idea is quite simple: when given an instance \mathbf{x} , the Softmax Regression model first computes a score $s_k(\mathbf{x})$ for each class k , then estimates the probability of each class by applying the *softmax function* (also called the *normalized exponential*) to the scores. The equation to compute $s_k(\mathbf{x})$ should look familiar, as it is just like the equation for Linear Regression prediction (see [Equation 4-19](#)).

Equation 4-19. Softmax score for class k

$$s_k(\mathbf{x}) = \mathbf{x}^T \boldsymbol{\theta}^{(k)}$$

Note that each class has its own dedicated parameter vector $\boldsymbol{\theta}^{(k)}$. All these vectors are typically stored as rows in a *parameter matrix* Θ .

Once you have computed the score of every class for the instance \mathbf{x} , you can estimate the probability \hat{p}_k that the instance belongs to class k by running the scores through the softmax function ([Equation 4-20](#)): it computes the exponential of every score,

then normalizes them (dividing by the sum of all the exponentials). The scores are generally called logits or log-odds (although they are actually unnormalized log-odds).

Equation 4-20. Softmax function

$$\hat{p}_k = \sigma(\mathbf{s}(\mathbf{x}))_k = \frac{\exp(s_k(\mathbf{x}))}{\sum_{j=1}^K \exp(s_j(\mathbf{x}))}$$

- K is the number of classes.
- $\mathbf{s}(\mathbf{x})$ is a vector containing the scores of each class for the instance \mathbf{x} .
- $\sigma(\mathbf{s}(\mathbf{x}))_k$ is the estimated probability that the instance \mathbf{x} belongs to class k given the scores of each class for that instance.

Just like the Logistic Regression classifier, the Softmax Regression classifier predicts the class with the highest estimated probability (which is simply the class with the highest score), as shown in [Equation 4-21](#).

Equation 4-21. Softmax Regression classifier prediction

$$\hat{y} = \operatorname{argmax}_k \sigma(\mathbf{s}(\mathbf{x}))_k = \operatorname{argmax}_k s_k(\mathbf{x}) = \operatorname{argmax}_k \left(\left(\boldsymbol{\theta}^{(k)} \right)^T \mathbf{x} \right)$$

- The *argmax* operator returns the value of a variable that maximizes a function. In this equation, it returns the value of k that maximizes the estimated probability $\sigma(\mathbf{s}(\mathbf{x}))_k$.



The Softmax Regression classifier predicts only one class at a time (i.e., it is multiclass, not multioutput) so it should be used only with mutually exclusive classes such as different types of plants. You cannot use it to recognize multiple people in one picture.

Now that you know how the model estimates probabilities and makes predictions, let's take a look at training. The objective is to have a model that estimates a high probability for the target class (and consequently a low probability for the other classes). Minimizing the cost function shown in [Equation 4-22](#), called the *cross entropy*, should lead to this objective because it penalizes the model when it estimates a low probability for a target class. Cross entropy is frequently used to measure how

well a set of estimated class probabilities match the target classes (we will use it again several times in the following chapters).

Equation 4-22. Cross entropy cost function

$$J(\Theta) = -\frac{1}{m} \sum_{i=1}^m \sum_{k=1}^K y_k^{(i)} \log(\hat{p}_k^{(i)})$$

- $y_k^{(i)}$ is the target probability that the i^{th} instance belongs to class k . In general, it is either equal to 1 or 0, depending on whether the instance belongs to the class or not.

Notice that when there are just two classes ($K = 2$), this cost function is equivalent to the Logistic Regression's cost function (log loss; see [Equation 4-17](#)).

Cross Entropy

Cross entropy originated from information theory. Suppose you want to efficiently transmit information about the weather every day. If there are eight options (sunny, rainy, etc.), you could encode each option using 3 bits since $2^3 = 8$. However, if you think it will be sunny almost every day, it would be much more efficient to code “sunny” on just one bit (0) and the other seven options on 4 bits (starting with a 1). Cross entropy measures the average number of bits you actually send per option. If your assumption about the weather is perfect, cross entropy will just be equal to the entropy of the weather itself (i.e., its intrinsic unpredictability). But if your assumptions are wrong (e.g., if it rains often), cross entropy will be greater by an amount called the *Kullback–Leibler divergence*.

The cross entropy between two probability distributions p and q is defined as $H(p, q) = -\sum_x p(x) \log q(x)$ (at least when the distributions are discrete). For more details, check out [this video](#).

The gradient vector of this cost function with regards to $\theta^{(k)}$ is given by [Equation 4-23](#):

Equation 4-23. Cross entropy gradient vector for class k

$$\nabla_{\theta^{(k)}} J(\Theta) = \frac{1}{m} \sum_{i=1}^m (\hat{p}_k^{(i)} - y_k^{(i)}) \mathbf{x}^{(i)}$$

Now you can compute the gradient vector for every class, then use Gradient Descent (or any other optimization algorithm) to find the parameter matrix Θ that minimizes the cost function.

Let's use Softmax Regression to classify the iris flowers into all three classes. Scikit-Learn's `LogisticRegression` uses one-versus-all by default when you train it on more than two classes, but you can set the `multi_class` hyperparameter to "multinomial" to switch it to Softmax Regression instead. You must also specify a solver that supports Softmax Regression, such as the "lbfgs" solver (see Scikit-Learn's documentation for more details). It also applies ℓ_2 regularization by default, which you can control using the hyperparameter `C`.

```
X = iris["data"][:, (2, 3)] # petal length, petal width
y = iris["target"]

softmax_reg = LogisticRegression(multi_class="multinomial", solver="lbfgs", C=10)
softmax_reg.fit(X, y)
```

So the next time you find an iris with 5 cm long and 2 cm wide petals, you can ask your model to tell you what type of iris it is, and it will answer Iris-Virginica (class 2) with 94.2% probability (or Iris-Versicolor with 5.8% probability):

```
>>> softmax_reg.predict([[5, 2]])
array([2])
>>> softmax_reg.predict_proba([[5, 2]])
array([[6.38014896e-07, 5.74929995e-02, 9.42506362e-01]])
```

Figure 4-25 shows the resulting decision boundaries, represented by the background colors. Notice that the decision boundaries between any two classes are linear. The figure also shows the probabilities for the Iris-Versicolor class, represented by the curved lines (e.g., the line labeled with 0.450 represents the 45% probability boundary). Notice that the model can predict a class that has an estimated probability below 50%. For example, at the point where all decision boundaries meet, all classes have an equal estimated probability of 33%.

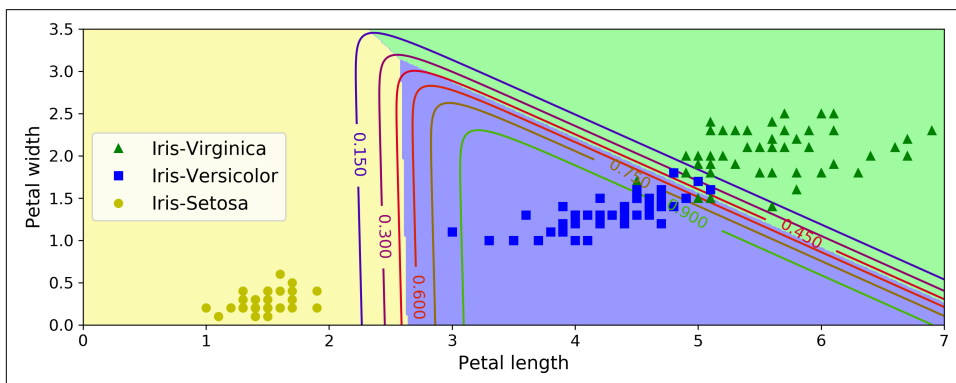

Figure 4-25. Softmax Regression decision boundaries

Exercises

1. What Linear Regression training algorithm can you use if you have a training set with millions of features?
2. Suppose the features in your training set have very different scales. What algorithms might suffer from this, and how? What can you do about it?
3. Can Gradient Descent get stuck in a local minimum when training a Logistic Regression model?
4. Do all Gradient Descent algorithms lead to the same model provided you let them run long enough?
5. Suppose you use Batch Gradient Descent and you plot the validation error at every epoch. If you notice that the validation error consistently goes up, what is likely going on? How can you fix this?
6. Is it a good idea to stop Mini-batch Gradient Descent immediately when the validation error goes up?
7. Which Gradient Descent algorithm (among those we discussed) will reach the vicinity of the optimal solution the fastest? Which will actually converge? How can you make the others converge as well?
8. Suppose you are using Polynomial Regression. You plot the learning curves and you notice that there is a large gap between the training error and the validation error. What is happening? What are three ways to solve this?
9. Suppose you are using Ridge Regression and you notice that the training error and the validation error are almost equal and fairly high. Would you say that the model suffers from high bias or high variance? Should you increase the regularization hyperparameter α or reduce it?
10. Why would you want to use:
 - Ridge Regression instead of plain Linear Regression (i.e., without any regularization)?
 - Lasso instead of Ridge Regression?
 - Elastic Net instead of Lasso?
11. Suppose you want to classify pictures as outdoor/indoor and daytime/nighttime. Should you implement two Logistic Regression classifiers or one Softmax Regression classifier?
12. Implement Batch Gradient Descent with early stopping for Softmax Regression (without using Scikit-Learn).

Solutions to these exercises are available in ???.

Support Vector Machines



With Early Release ebooks, you get books in their earliest form—the author’s raw and unedited content as he or she writes—so you can take advantage of these technologies long before the official release of these titles. The following will be Chapter 5 in the final release of the book.

A *Support Vector Machine* (SVM) is a very powerful and versatile Machine Learning model, capable of performing linear or nonlinear classification, regression, and even outlier detection. It is one of the most popular models in Machine Learning, and anyone interested in Machine Learning should have it in their toolbox. SVMs are particularly well suited for classification of complex but small- or medium-sized datasets.

This chapter will explain the core concepts of SVMs, how to use them, and how they work.

Linear SVM Classification

The fundamental idea behind SVMs is best explained with some pictures. [Figure 5-1](#) shows part of the iris dataset that was introduced at the end of [Chapter 4](#). The two classes can clearly be separated easily with a straight line (they are *linearly separable*). The left plot shows the decision boundaries of three possible linear classifiers. The model whose decision boundary is represented by the dashed line is so bad that it does not even separate the classes properly. The other two models work perfectly on this training set, but their decision boundaries come so close to the instances that these models will probably not perform as well on new instances. In contrast, the solid line in the plot on the right represents the decision boundary of an SVM classifier; this line not only separates the two classes but also stays as far away from the closest training instances as possible. You can think of an SVM classifier as fitting the

widest possible street (represented by the parallel dashed lines) between the classes. This is called *large margin classification*.

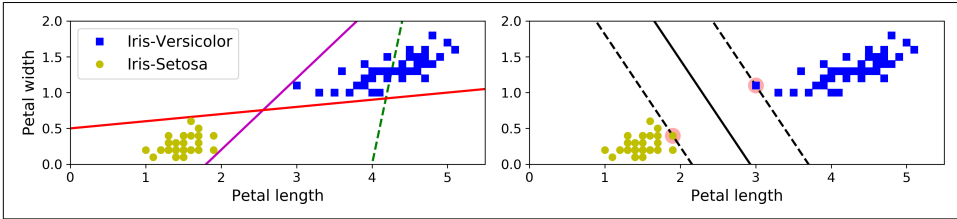

Figure 5-1. Large margin classification

Notice that adding more training instances “off the street” will not affect the decision boundary at all: it is fully determined (or “supported”) by the instances located on the edge of the street. These instances are called the *support vectors* (they are circled in Figure 5-1).



SVMs are sensitive to the feature scales, as you can see in Figure 5-2: on the left plot, the vertical scale is much larger than the horizontal scale, so the widest possible street is close to horizontal. After feature scaling (e.g., using Scikit-Learn’s `StandardScaler`), the decision boundary looks much better (on the right plot).

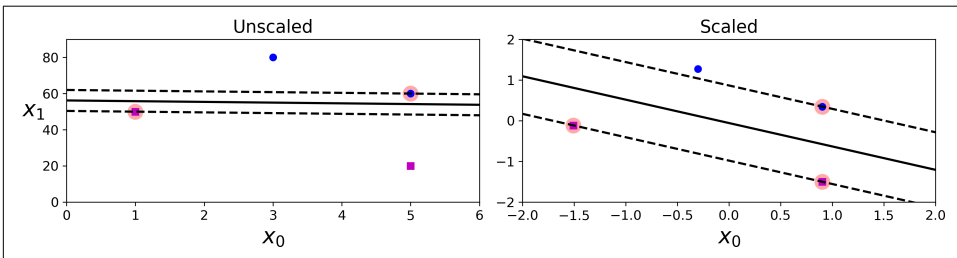

Figure 5-2. Sensitivity to feature scales

Soft Margin Classification

If we strictly impose that all instances be off the street and on the right side, this is called *hard margin classification*. There are two main issues with hard margin classification. First, it only works if the data is linearly separable, and second it is quite sensitive to outliers. Figure 5-3 shows the iris dataset with just one additional outlier: on the left, it is impossible to find a hard margin, and on the right the decision boundary ends up very different from the one we saw in Figure 5-1 without the outlier, and it will probably not generalize as well.

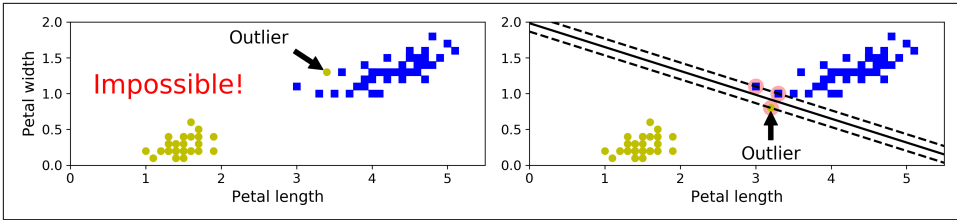

Figure 5-3. Hard margin sensitivity to outliers

To avoid these issues it is preferable to use a more flexible model. The objective is to find a good balance between keeping the street as large as possible and limiting the *margin violations* (i.e., instances that end up in the middle of the street or even on the wrong side). This is called *soft margin classification*.

In Scikit-Learn’s SVM classes, you can control this balance using the C hyperparameter: a smaller C value leads to a wider street but more margin violations. Figure 5-4 shows the decision boundaries and margins of two soft margin SVM classifiers on a nonlinearly separable dataset. On the left, using a low C value the margin is quite large, but many instances end up on the street. On the right, using a high C value the classifier makes fewer margin violations but ends up with a smaller margin. However, it seems likely that the first classifier will generalize better: in fact even on this training set it makes fewer prediction errors, since most of the margin violations are actually on the correct side of the decision boundary.

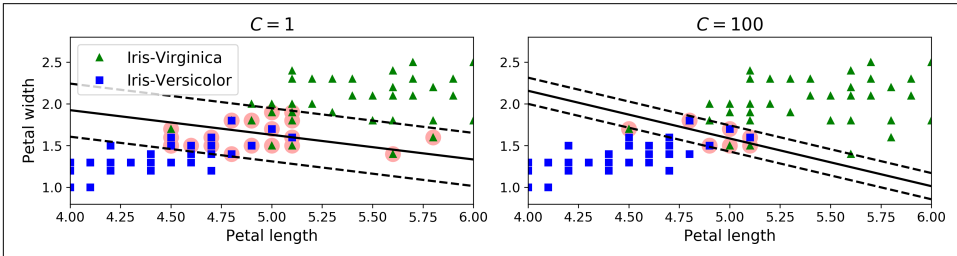

Figure 5-4. Large margin (left) versus fewer margin violations (right)



If your SVM model is overfitting, you can try regularizing it by reducing C .

The following Scikit-Learn code loads the iris dataset, scales the features, and then trains a linear SVM model (using the `LinearSVC` class with $C = 1$ and the *hinge loss* function, described shortly) to detect Iris-Virginica flowers. The resulting model is represented on the left of Figure 5-4.

```

import numpy as np
from sklearn import datasets
from sklearn.pipeline import Pipeline
from sklearn.preprocessing import StandardScaler
from sklearn.svm import LinearSVC

iris = datasets.load_iris()
X = iris["data"][:, (2, 3)] # petal length, petal width
y = (iris["target"] == 2).astype(np.float64) # Iris-Virginica

svm_clf = Pipeline([
    ("scaler", StandardScaler()),
    ("linear_svc", LinearSVC(C=1, loss="hinge")),
])

svm_clf.fit(X, y)

```

Then, as usual, you can use the model to make predictions:

```

>>> svm_clf.predict([[5.5, 1.7]])
array([1.])

```



Unlike Logistic Regression classifiers, SVM classifiers do not output probabilities for each class.

Alternatively, you could use the SVC class, using `SVC(kernel="linear", C=1)`, but it is much slower, especially with large training sets, so it is not recommended. Another option is to use the `SGDClassifier` class, with `SGDClassifier(loss="hinge", alpha=1/(m*C))`. This applies regular Stochastic Gradient Descent (see [Chapter 4](#)) to train a linear SVM classifier. It does not converge as fast as the `LinearSVC` class, but it can be useful to handle huge datasets that do not fit in memory (out-of-core training), or to handle online classification tasks.



The `LinearSVC` class regularizes the bias term, so you should center the training set first by subtracting its mean. This is automatic if you scale the data using the `StandardScaler`. Moreover, make sure you set the `loss` hyperparameter to "hinge", as it is not the default value. Finally, for better performance you should set the `dual` hyperparameter to `False`, unless there are more features than training instances (we will discuss duality later in the chapter).

Nonlinear SVM Classification

Although linear SVM classifiers are efficient and work surprisingly well in many cases, many datasets are not even close to being linearly separable. One approach to handling nonlinear datasets is to add more features, such as polynomial features (as you did in [Chapter 4](#)); in some cases this can result in a linearly separable dataset. Consider the left plot in [Figure 5-5](#): it represents a simple dataset with just one feature x_1 . This dataset is not linearly separable, as you can see. But if you add a second feature $x_2 = (x_1)^2$, the resulting 2D dataset is perfectly linearly separable.

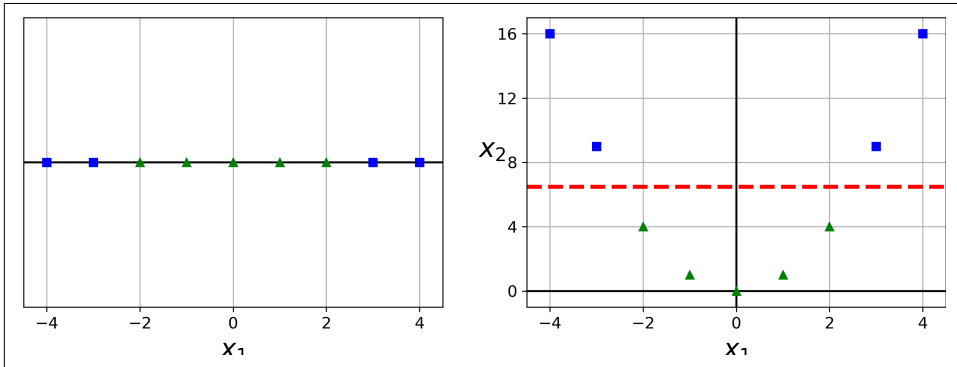

Figure 5-5. Adding features to make a dataset linearly separable

To implement this idea using Scikit-Learn, you can create a Pipeline containing a `PolynomialFeatures` transformer (discussed in “[Polynomial Regression](#)” on page 130), followed by a `StandardScaler` and a `LinearSVC`. Let’s test this on the moons dataset: this is a toy dataset for binary classification in which the data points are shaped as two interleaving half circles (see [Figure 5-6](#)). You can generate this dataset using the `make_moons()` function:

```
from sklearn.datasets import make_moons
from sklearn.pipeline import Pipeline
from sklearn.preprocessing import PolynomialFeatures

polynomial_svm_clf = Pipeline([
    ("poly_features", PolynomialFeatures(degree=3)),
    ("scaler", StandardScaler()),
    ("svm_clf", LinearSVC(C=10, loss="hinge"))
])

polynomial_svm_clf.fit(X, y)
```

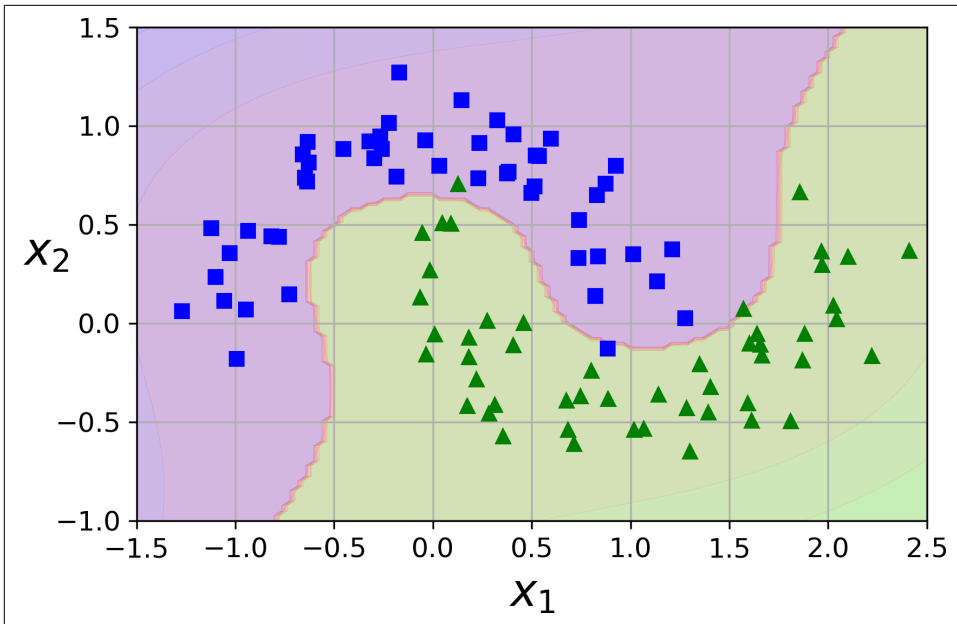

Figure 5-6. Linear SVM classifier using polynomial features

Polynomial Kernel

Adding polynomial features is simple to implement and can work great with all sorts of Machine Learning algorithms (not just SVMs), but at a low polynomial degree it cannot deal with very complex datasets, and with a high polynomial degree it creates a huge number of features, making the model too slow.

Fortunately, when using SVMs you can apply an almost miraculous mathematical technique called the *kernel trick* (it is explained in a moment). It makes it possible to get the same result as if you added many polynomial features, even with very high-degree polynomials, without actually having to add them. So there is no combinatorial explosion of the number of features since you don't actually add any features. This trick is implemented by the SVC class. Let's test it on the moons dataset:

```
from sklearn.svm import SVC
poly_kernel_svm_clf = Pipeline([
    ("scaler", StandardScaler()),
    ("svm_clf", SVC(kernel="poly", degree=3, coef0=1, C=5))
])
poly_kernel_svm_clf.fit(X, y)
```

This code trains an SVM classifier using a 3rd-degree polynomial kernel. It is represented on the left of Figure 5-7. On the right is another SVM classifier using a 10th-degree polynomial kernel. Obviously, if your model is overfitting, you might want to

reduce the polynomial degree. Conversely, if it is underfitting, you can try increasing it. The hyperparameter `coef0` controls how much the model is influenced by high-degree polynomials versus low-degree polynomials.

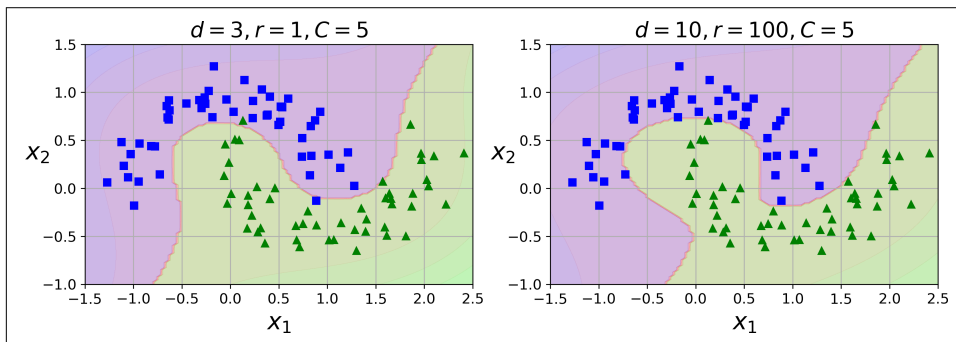

Figure 5-7. SVM classifiers with a polynomial kernel



A common approach to find the right hyperparameter values is to use grid search (see [Chapter 2](#)). It is often faster to first do a very coarse grid search, then a finer grid search around the best values found. Having a good sense of what each hyperparameter actually does can also help you search in the right part of the hyperparameter space.

Adding Similarity Features

Another technique to tackle nonlinear problems is to add features computed using a *similarity function* that measures how much each instance resembles a particular *landmark*. For example, let's take the one-dimensional dataset discussed earlier and add two landmarks to it at $x_1 = -2$ and $x_1 = 1$ (see the left plot in [Figure 5-8](#)). Next, let's define the similarity function to be the *Gaussian Radial Basis Function (RBF)* with $\gamma = 0.3$ (see [Equation 5-1](#)).

Equation 5-1. Gaussian RBF

$$\phi_{\gamma}(\mathbf{x}, \ell) = \exp\left(-\gamma\|\mathbf{x} - \ell\|^2\right)$$

It is a bell-shaped function varying from 0 (very far away from the landmark) to 1 (at the landmark). Now we are ready to compute the new features. For example, let's look at the instance $x_1 = -1$: it is located at a distance of 1 from the first landmark, and 2 from the second landmark. Therefore its new features are $x_2 = \exp(-0.3 \times 1^2) \approx 0.74$ and $x_3 = \exp(-0.3 \times 2^2) \approx 0.30$. The plot on the right of [Figure 5-8](#) shows the transformed dataset (dropping the original features). As you can see, it is now linearly separable.

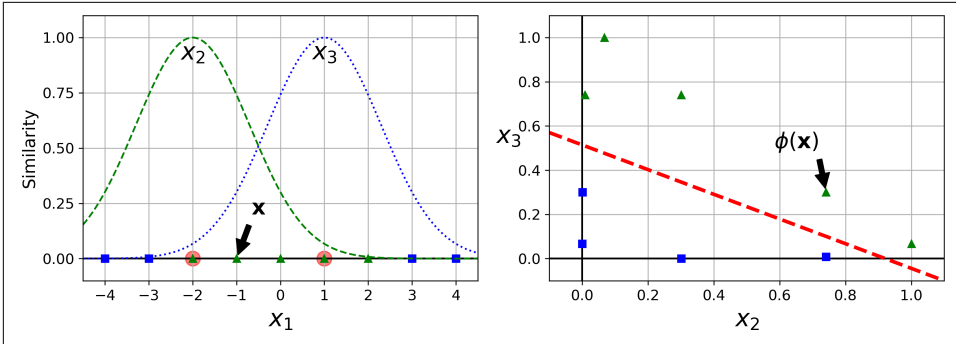

Figure 5-8. Similarity features using the Gaussian RBF

You may wonder how to select the landmarks. The simplest approach is to create a landmark at the location of each and every instance in the dataset. This creates many dimensions and thus increases the chances that the transformed training set will be linearly separable. The downside is that a training set with m instances and n features gets transformed into a training set with m instances and m features (assuming you drop the original features). If your training set is very large, you end up with an equally large number of features.

Gaussian RBF Kernel

Just like the polynomial features method, the similarity features method can be useful with any Machine Learning algorithm, but it may be computationally expensive to compute all the additional features, especially on large training sets. However, once again the kernel trick does its SVM magic: it makes it possible to obtain a similar result as if you had added many similarity features, without actually having to add them. Let's try the Gaussian RBF kernel using the `SVC` class:

```
rbf_kernel_svm_clf = Pipeline([
    ("scaler", StandardScaler()),
    ("svm_clf", SVC(kernel="rbf", gamma=5, C=0.001))
])
rbf_kernel_svm_clf.fit(X, y)
```

This model is represented on the bottom left of Figure 5-9. The other plots show models trained with different values of hyperparameters `gamma` (γ) and `C`. Increasing `gamma` makes the bell-shape curve narrower (see the left plot of Figure 5-8), and as a result each instance's range of influence is smaller: the decision boundary ends up being more irregular, wiggling around individual instances. Conversely, a small `gamma` value makes the bell-shaped curve wider, so instances have a larger range of influence, and the decision boundary ends up smoother. So γ acts like a regularization hyperparameter: if your model is overfitting, you should reduce it, and if it is underfitting, you should increase it (similar to the `C` hyperparameter).

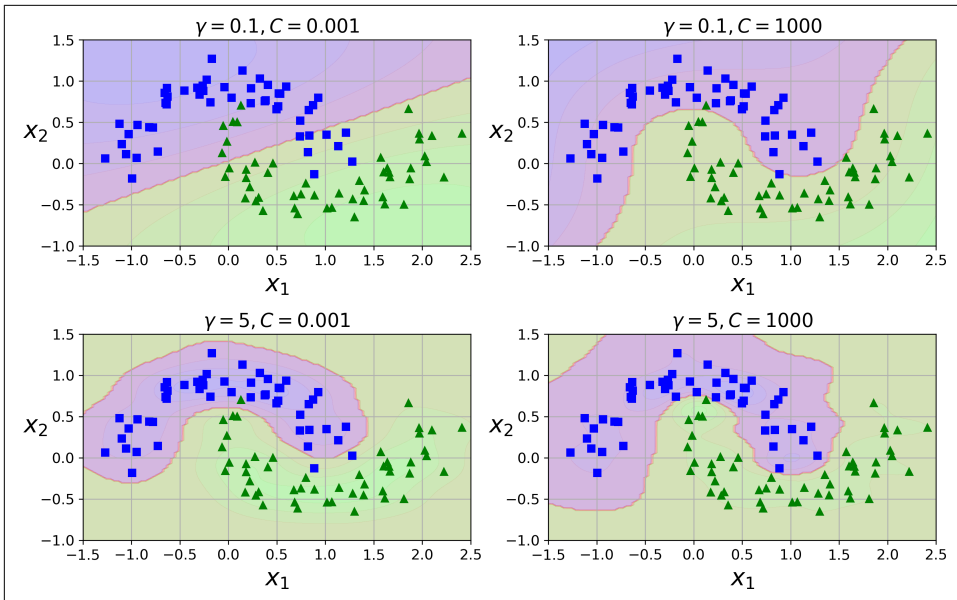

Figure 5-9. SVM classifiers using an RBF kernel

Other kernels exist but are used much more rarely. For example, some kernels are specialized for specific data structures. *String kernels* are sometimes used when classifying text documents or DNA sequences (e.g., using the *string subsequence kernel* or kernels based on the *Levenshtein distance*).



With so many kernels to choose from, how can you decide which one to use? As a rule of thumb, you should always try the linear kernel first (remember that `LinearSVC` is much faster than `SVC(kernel="linear")`), especially if the training set is very large or if it has plenty of features. If the training set is not too large, you should try the Gaussian RBF kernel as well; it works well in most cases. Then if you have spare time and computing power, you can also experiment with a few other kernels using cross-validation and grid search, especially if there are kernels specialized for your training set's data structure.

Computational Complexity

The `LinearSVC` class is based on the *liblinear* library, which implements an **optimized algorithm** for linear SVMs.¹ It does not support the kernel trick, but it scales almost

¹ "A Dual Coordinate Descent Method for Large-scale Linear SVM," Lin et al. (2008).

linearly with the number of training instances and the number of features: its training time complexity is roughly $O(m \times n)$.

The algorithm takes longer if you require a very high precision. This is controlled by the tolerance hyperparameter ϵ (called `tol` in Scikit-Learn). In most classification tasks, the default tolerance is fine.

The SVC class is based on the *libsvm* library, which implements **an algorithm** that supports the kernel trick.² The training time complexity is usually between $O(m^2 \times n)$ and $O(m^3 \times n)$. Unfortunately, this means that it gets dreadfully slow when the number of training instances gets large (e.g., hundreds of thousands of instances). This algorithm is perfect for complex but small or medium training sets. However, it scales well with the number of features, especially with *sparse features* (i.e., when each instance has few nonzero features). In this case, the algorithm scales roughly with the average number of nonzero features per instance. **Table 5-1** compares Scikit-Learn's SVM classification classes.

Table 5-1. Comparison of Scikit-Learn classes for SVM classification

Class	Time complexity	Out-of-core support	Scaling required	Kernel trick
LinearSVC	$O(m \times n)$	No	Yes	No
SGDClassifier	$O(m \times n)$	Yes	Yes	No
SVC	$O(m^2 \times n)$ to $O(m^3 \times n)$	No	Yes	Yes

SVM Regression

As we mentioned earlier, the SVM algorithm is quite versatile: not only does it support linear and nonlinear classification, but it also supports linear and nonlinear regression. The trick is to reverse the objective: instead of trying to fit the largest possible street between two classes while limiting margin violations, SVM Regression tries to fit as many instances as possible *on* the street while limiting margin violations (i.e., instances *off* the street). The width of the street is controlled by a hyperparameter ϵ . **Figure 5-10** shows two linear SVM Regression models trained on some random linear data, one with a large margin ($\epsilon = 1.5$) and the other with a small margin ($\epsilon = 0.5$).

² "Sequential Minimal Optimization (SMO)," J. Platt (1998).

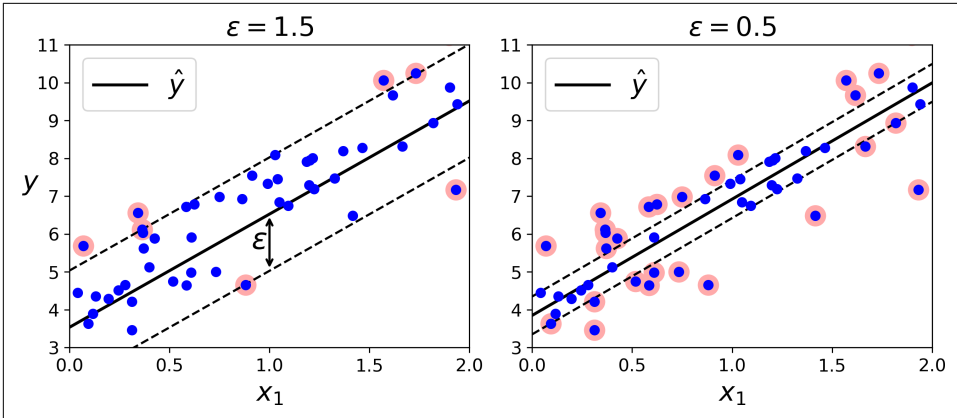

Figure 5-10. SVM Regression

Adding more training instances within the margin does not affect the model's predictions; thus, the model is said to be ϵ -insensitive.

You can use Scikit-Learn's `LinearSVR` class to perform linear SVM Regression. The following code produces the model represented on the left of Figure 5-10 (the training data should be scaled and centered first):

```
from sklearn.svm import LinearSVR

svm_reg = LinearSVR(epsilon=1.5)
svm_reg.fit(X, y)
```

To tackle nonlinear regression tasks, you can use a kernelized SVM model. For example, Figure 5-11 shows SVM Regression on a random quadratic training set, using a 2nd-degree polynomial kernel. There is little regularization on the left plot (i.e., a large C value), and much more regularization on the right plot (i.e., a small C value).

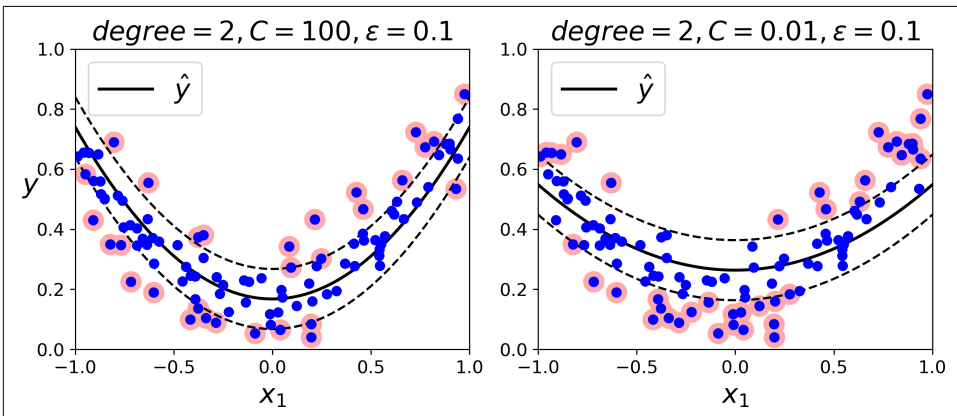

Figure 5-11. SVM regression using a 2nd-degree polynomial kernel

The following code produces the model represented on the left of [Figure 5-11](#) using Scikit-Learn's SVR class (which supports the kernel trick). The SVR class is the regression equivalent of the SVC class, and the LinearSVR class is the regression equivalent of the LinearSVC class. The LinearSVR class scales linearly with the size of the training set (just like the LinearSVC class), while the SVR class gets much too slow when the training set grows large (just like the SVC class).

```
from sklearn.svm import SVR

svm_poly_reg = SVR(kernel="poly", degree=2, C=100, epsilon=0.1)
svm_poly_reg.fit(X, y)
```



SVMs can also be used for outlier detection; see Scikit-Learn's documentation for more details.

Under the Hood

This section explains how SVMs make predictions and how their training algorithms work, starting with linear SVM classifiers. You can safely skip it and go straight to the exercises at the end of this chapter if you are just getting started with Machine Learning, and come back later when you want to get a deeper understanding of SVMs.

First, a word about notations: in [Chapter 4](#) we used the convention of putting all the model parameters in one vector θ , including the bias term θ_0 and the input feature weights θ_1 to θ_n , and adding a bias input $x_0 = 1$ to all instances. In this chapter, we will use a different convention, which is more convenient (and more common) when you are dealing with SVMs: the bias term will be called b and the feature weights vector will be called \mathbf{w} . No bias feature will be added to the input feature vectors.

Decision Function and Predictions

The linear SVM classifier model predicts the class of a new instance \mathbf{x} by simply computing the decision function $\mathbf{w}^T \mathbf{x} + b = w_1 x_1 + \dots + w_n x_n + b$: if the result is positive, the predicted class \hat{y} is the positive class (1), or else it is the negative class (0); see [Equation 5-2](#).

Equation 5-2. Linear SVM classifier prediction

$$\hat{y} = \begin{cases} 0 & \text{if } \mathbf{w}^T \mathbf{x} + b < 0, \\ 1 & \text{if } \mathbf{w}^T \mathbf{x} + b \geq 0 \end{cases}$$

Figure 5-12 shows the decision function that corresponds to the model on the left of Figure 5-4: it is a two-dimensional plane since this dataset has two features (petal width and petal length). The decision boundary is the set of points where the decision function is equal to 0: it is the intersection of two planes, which is a straight line (represented by the thick solid line).³

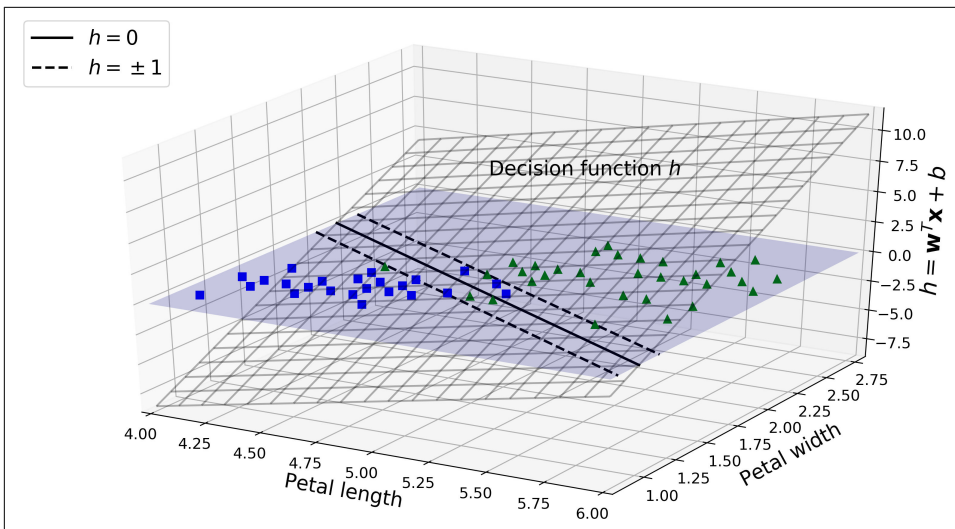

Figure 5-12. Decision function for the iris dataset

The dashed lines represent the points where the decision function is equal to 1 or -1 : they are parallel and at equal distance to the decision boundary, forming a margin around it. Training a linear SVM classifier means finding the value of \mathbf{w} and b that make this margin as wide as possible while avoiding margin violations (hard margin) or limiting them (soft margin).

Training Objective

Consider the slope of the decision function: it is equal to the norm of the weight vector, $\|\mathbf{w}\|$. If we divide this slope by 2, the points where the decision function is equal to ± 1 are going to be twice as far away from the decision boundary. In other words, dividing the slope by 2 will multiply the margin by 2. Perhaps this is easier to visualize in 2D in Figure 5-13. The smaller the weight vector \mathbf{w} , the larger the margin.

³ More generally, when there are n features, the decision function is an n -dimensional *hyperplane*, and the decision boundary is an $(n - 1)$ -dimensional hyperplane.

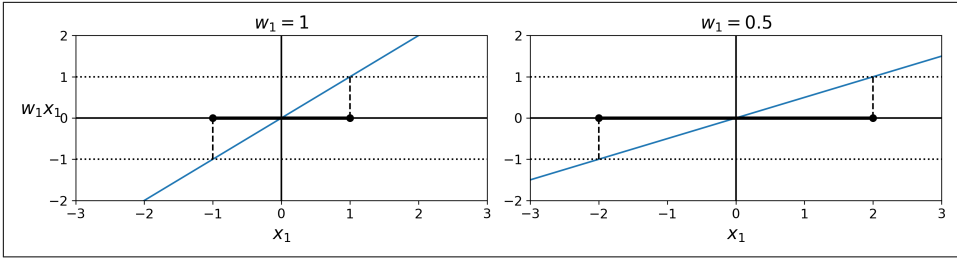

Figure 5-13. A smaller weight vector results in a larger margin

So we want to minimize $\| \mathbf{w} \|$ to get a large margin. However, if we also want to avoid any margin violation (hard margin), then we need the decision function to be greater than 1 for all positive training instances, and lower than -1 for negative training instances. If we define $t^{(i)} = -1$ for negative instances (if $y^{(i)} = 0$) and $t^{(i)} = 1$ for positive instances (if $y^{(i)} = 1$), then we can express this constraint as $t^{(i)}(\mathbf{w}^T \mathbf{x}^{(i)} + b) \geq 1$ for all instances.

We can therefore express the hard margin linear SVM classifier objective as the *constrained optimization* problem in Equation 5-3.

Equation 5-3. Hard margin linear SVM classifier objective

$$\begin{aligned} & \underset{\mathbf{w}, b}{\text{minimize}} && \frac{1}{2} \mathbf{w}^T \mathbf{w} \\ & \text{subject to} && t^{(i)}(\mathbf{w}^T \mathbf{x}^{(i)} + b) \geq 1 \quad \text{for } i = 1, 2, \dots, m \end{aligned}$$



We are minimizing $\frac{1}{2} \mathbf{w}^T \mathbf{w}$, which is equal to $\frac{1}{2} \| \mathbf{w} \|^2$, rather than minimizing $\| \mathbf{w} \|$. Indeed, $\frac{1}{2} \| \mathbf{w} \|^2$ has a nice and simple derivative (it is just \mathbf{w}) while $\| \mathbf{w} \|$ is not differentiable at $\mathbf{w} = \mathbf{0}$. Optimization algorithms work much better on differentiable functions.

To get the soft margin objective, we need to introduce a *slack variable* $\zeta^{(i)} \geq 0$ for each instance:⁴ $\zeta^{(i)}$ measures how much the i^{th} instance is allowed to violate the margin. We now have two conflicting objectives: making the slack variables as small as possible to reduce the margin violations, and making $\frac{1}{2} \mathbf{w}^T \mathbf{w}$ as small as possible to increase the margin. This is where the C hyperparameter comes in: it allows us to define the trade-

⁴ Zeta (ζ) is the 6th letter of the Greek alphabet.

off between these two objectives. This gives us the constrained optimization problem in [Equation 5-4](#).

Equation 5-4. Soft margin linear SVM classifier objective

$$\begin{aligned} & \underset{\mathbf{w}, b, \zeta}{\text{minimize}} && \frac{1}{2} \mathbf{w}^T \mathbf{w} + C \sum_{i=1}^m \zeta^{(i)} \\ & \text{subject to} && t^{(i)} (\mathbf{w}^T \mathbf{x}^{(i)} + b) \geq 1 - \zeta^{(i)} \quad \text{and} \quad \zeta^{(i)} \geq 0 \quad \text{for } i = 1, 2, \dots, m \end{aligned}$$

Quadratic Programming

The hard margin and soft margin problems are both convex quadratic optimization problems with linear constraints. Such problems are known as *Quadratic Programming* (QP) problems. Many off-the-shelf solvers are available to solve QP problems using a variety of techniques that are outside the scope of this book.⁵ The general problem formulation is given by [Equation 5-5](#).

Equation 5-5. Quadratic Programming problem

$$\begin{aligned} & \underset{\mathbf{p}}{\text{Minimize}} && \frac{1}{2} \mathbf{p}^T \mathbf{H} \mathbf{p} + \mathbf{f}^T \mathbf{p} \\ & \text{subject to} && \mathbf{A} \mathbf{p} \leq \mathbf{b} \end{aligned}$$

where

$$\left\{ \begin{array}{l} \mathbf{p} \text{ is an } n_p\text{-dimensional vector (} n_p = \text{number of parameters),} \\ \mathbf{H} \text{ is an } n_p \times n_p \text{ matrix,} \\ \mathbf{f} \text{ is an } n_p\text{-dimensional vector,} \\ \mathbf{A} \text{ is an } n_c \times n_p \text{ matrix (} n_c = \text{number of constraints),} \\ \mathbf{b} \text{ is an } n_c\text{-dimensional vector.} \end{array} \right.$$

Note that the expression $\mathbf{A} \mathbf{p} \leq \mathbf{b}$ actually defines n_c constraints: $\mathbf{p}^T \mathbf{a}^{(i)} \leq b^{(i)}$ for $i = 1, 2, \dots, n_c$, where $\mathbf{a}^{(i)}$ is the vector containing the elements of the i^{th} row of \mathbf{A} and $b^{(i)}$ is the i^{th} element of \mathbf{b} .

You can easily verify that if you set the QP parameters in the following way, you get the hard margin linear SVM classifier objective:

- $n_p = n + 1$, where n is the number of features (the +1 is for the bias term).

⁵ To learn more about Quadratic Programming, you can start by reading Stephen Boyd and Lieven Vandenberghe, *Convex Optimization* (Cambridge, UK: Cambridge University Press, 2004) or watch Richard Brown's [series of video lectures](#).

- $n_c = m$, where m is the number of training instances.
- \mathbf{H} is the $n_p \times n_p$ identity matrix, except with a zero in the top-left cell (to ignore the bias term).
- $\mathbf{f} = \mathbf{0}$, an n_p -dimensional vector full of 0s.
- $\mathbf{b} = -\mathbf{1}$, an n_c -dimensional vector full of -1s.
- $\mathbf{a}^{(i)} = -t^{(i)} \dot{\mathbf{x}}^{(i)}$, where $\dot{\mathbf{x}}^{(i)}$ is equal to $\mathbf{x}^{(i)}$ with an extra bias feature $\dot{\mathbf{x}}_0 = 1$.

So one way to train a hard margin linear SVM classifier is just to use an off-the-shelf QP solver by passing it the preceding parameters. The resulting vector \mathbf{p} will contain the bias term $b = p_0$ and the feature weights $w_i = p_i$ for $i = 1, 2, \dots, n$. Similarly, you can use a QP solver to solve the soft margin problem (see the exercises at the end of the chapter).

However, to use the kernel trick we are going to look at a different constrained optimization problem.

The Dual Problem

Given a constrained optimization problem, known as the *primal problem*, it is possible to express a different but closely related problem, called its *dual problem*. The solution to the dual problem typically gives a lower bound to the solution of the primal problem, but under some conditions it can even have the same solutions as the primal problem. Luckily, the SVM problem happens to meet these conditions,⁶ so you can choose to solve the primal problem or the dual problem; both will have the same solution. Equation 5-6 shows the dual form of the linear SVM objective (if you are interested in knowing how to derive the dual problem from the primal problem, see ???).

Equation 5-6. Dual form of the linear SVM objective

$$\begin{aligned} \underset{\alpha}{\text{minimize}} \quad & \frac{1}{2} \sum_{i=1}^m \sum_{j=1}^m \alpha^{(i)} \alpha^{(j)} t^{(i)} t^{(j)} \mathbf{x}^{(i)T} \mathbf{x}^{(j)} \quad - \quad \sum_{i=1}^m \alpha^{(i)} \\ \text{subject to} \quad & \alpha^{(i)} \geq 0 \quad \text{for } i = 1, 2, \dots, m \end{aligned}$$

⁶ The objective function is convex, and the inequality constraints are continuously differentiable and convex functions.

Once you find the vector $\hat{\alpha}$ that minimizes this equation (using a QP solver), you can compute $\hat{\mathbf{w}}$ and \hat{b} that minimize the primal problem by using [Equation 5-7](#).

Equation 5-7. From the dual solution to the primal solution

$$\hat{\mathbf{w}} = \sum_{i=1}^m \hat{\alpha}^{(i)} t^{(i)} \mathbf{x}^{(i)}$$

$$\hat{b} = \frac{1}{n_s} \sum_{\substack{i=1 \\ \hat{\alpha}^{(i)} > 0}}^m (t^{(i)} - \hat{\mathbf{w}}^T \mathbf{x}^{(i)})$$

The dual problem is faster to solve than the primal when the number of training instances is smaller than the number of features. More importantly, it makes the kernel trick possible, while the primal does not. So what is this kernel trick anyway?

Kernelized SVM

Suppose you want to apply a 2nd-degree polynomial transformation to a two-dimensional training set (such as the moons training set), then train a linear SVM classifier on the transformed training set. [Equation 5-8](#) shows the 2nd-degree polynomial mapping function ϕ that you want to apply.

Equation 5-8. Second-degree polynomial mapping

$$\phi(\mathbf{x}) = \phi\left(\begin{pmatrix} x_1 \\ x_2 \end{pmatrix}\right) = \begin{pmatrix} x_1^2 \\ \sqrt{2} x_1 x_2 \\ x_2^2 \end{pmatrix}$$

Notice that the transformed vector is three-dimensional instead of two-dimensional. Now let's look at what happens to a couple of two-dimensional vectors, \mathbf{a} and \mathbf{b} , if we apply this 2nd-degree polynomial mapping and then compute the dot product⁷ of the transformed vectors (See [Equation 5-9](#)).

⁷ As explained in [Chapter 4](#), the dot product of two vectors \mathbf{a} and \mathbf{b} is normally noted $\mathbf{a} \cdot \mathbf{b}$. However, in Machine Learning, vectors are frequently represented as column vectors (i.e., single-column matrices), so the dot product is achieved by computing $\mathbf{a}^T \mathbf{b}$. To remain consistent with the rest of the book, we will use this notation here, ignoring the fact that this technically results in a single-cell matrix rather than a scalar value.

Equation 5-9. Kernel trick for a 2nd-degree polynomial mapping

$$\begin{aligned}\phi(\mathbf{a})^T \phi(\mathbf{b}) &= \begin{pmatrix} a_1^2 \\ \sqrt{2} a_1 a_2 \\ a_2^2 \end{pmatrix}^T \begin{pmatrix} b_1^2 \\ \sqrt{2} b_1 b_2 \\ b_2^2 \end{pmatrix} = a_1^2 b_1^2 + 2a_1 b_1 a_2 b_2 + a_2^2 b_2^2 \\ &= (a_1 b_1 + a_2 b_2)^2 = \left(\begin{pmatrix} a_1 \\ a_2 \end{pmatrix}^T \begin{pmatrix} b_1 \\ b_2 \end{pmatrix} \right)^2 = (\mathbf{a}^T \mathbf{b})^2\end{aligned}$$

How about that? The dot product of the transformed vectors is equal to the square of the dot product of the original vectors: $\phi(\mathbf{a})^T \phi(\mathbf{b}) = (\mathbf{a}^T \mathbf{b})^2$.

Now here is the key insight: if you apply the transformation ϕ to all training instances, then the dual problem (see Equation 5-6) will contain the dot product $\phi(\mathbf{x}^{(i)})^T \phi(\mathbf{x}^{(j)})$. But if ϕ is the 2nd-degree polynomial transformation defined in Equation 5-8, then you can replace this dot product of transformed vectors simply by $(\mathbf{x}^{(i)T} \mathbf{x}^{(j)})^2$. So you don't actually need to transform the training instances at all: just replace the dot product by its square in Equation 5-6. The result will be strictly the same as if you went through the trouble of actually transforming the training set then fitting a linear SVM algorithm, but this trick makes the whole process much more computationally efficient. This is the essence of the kernel trick.

The function $K(\mathbf{a}, \mathbf{b}) = (\mathbf{a}^T \mathbf{b})^2$ is called a 2nd-degree *polynomial kernel*. In Machine Learning, a *kernel* is a function capable of computing the dot product $\phi(\mathbf{a})^T \phi(\mathbf{b})$ based only on the original vectors \mathbf{a} and \mathbf{b} , without having to compute (or even to know about) the transformation ϕ . Equation 5-10 lists some of the most commonly used kernels.

Equation 5-10. Common kernels

$$\begin{aligned}\text{Linear:} \quad K(\mathbf{a}, \mathbf{b}) &= \mathbf{a}^T \mathbf{b} \\ \text{Polynomial:} \quad K(\mathbf{a}, \mathbf{b}) &= (\gamma \mathbf{a}^T \mathbf{b} + r)^d \\ \text{Gaussian RBF:} \quad K(\mathbf{a}, \mathbf{b}) &= \exp(-\gamma \|\mathbf{a} - \mathbf{b}\|^2) \\ \text{Sigmoid:} \quad K(\mathbf{a}, \mathbf{b}) &= \tanh(\gamma \mathbf{a}^T \mathbf{b} + r)\end{aligned}$$

Mercer's Theorem

According to *Mercer's theorem*, if a function $K(\mathbf{a}, \mathbf{b})$ respects a few mathematical conditions called *Mercer's conditions* (K must be continuous, symmetric in its arguments so $K(\mathbf{a}, \mathbf{b}) = K(\mathbf{b}, \mathbf{a})$, etc.), then there exists a function ϕ that maps \mathbf{a} and \mathbf{b} into another space (possibly with much higher dimensions) such that $K(\mathbf{a}, \mathbf{b}) = \phi(\mathbf{a})^T \phi(\mathbf{b})$. So you can use K as a kernel since you know ϕ exists, even if you don't know what ϕ is. In the case of the Gaussian RBF kernel, it can be shown that ϕ actually maps each training instance to an infinite-dimensional space, so it's a good thing you don't need to actually perform the mapping!

Note that some frequently used kernels (such as the Sigmoid kernel) don't respect all of Mercer's conditions, yet they generally work well in practice.

There is still one loose end we must tie. [Equation 5-7](#) shows how to go from the dual solution to the primal solution in the case of a linear SVM classifier, but if you apply the kernel trick you end up with equations that include $\phi(\mathbf{x}^{(i)})$. In fact, $\widehat{\mathbf{w}}$ must have the same number of dimensions as $\phi(\mathbf{x}^{(i)})$, which may be huge or even infinite, so you can't compute it. But how can you make predictions without knowing $\widehat{\mathbf{w}}$? Well, the good news is that you can plug in the formula for $\widehat{\mathbf{w}}$ from [Equation 5-7](#) into the decision function for a new instance $\mathbf{x}^{(n)}$, and you get an equation with only dot products between input vectors. This makes it possible to use the kernel trick, once again ([Equation 5-11](#)).

Equation 5-11. Making predictions with a kernelized SVM

$$\begin{aligned} h_{\widehat{\mathbf{w}}, \widehat{b}}(\phi(\mathbf{x}^{(n)})) &= \widehat{\mathbf{w}}^T \phi(\mathbf{x}^{(n)}) + \widehat{b} = \left(\sum_{i=1}^m \widehat{\alpha}^{(i)} t^{(i)} \phi(\mathbf{x}^{(i)}) \right)^T \phi(\mathbf{x}^{(n)}) + \widehat{b} \\ &= \sum_{i=1}^m \widehat{\alpha}^{(i)} t^{(i)} \left(\phi(\mathbf{x}^{(i)})^T \phi(\mathbf{x}^{(n)}) \right) + \widehat{b} \\ &= \sum_{i=1}^m \widehat{\alpha}^{(i)} t^{(i)} K(\mathbf{x}^{(i)}, \mathbf{x}^{(n)}) + \widehat{b} \\ &\quad \widehat{\alpha}^{(i)} > 0 \end{aligned}$$

Note that since $\alpha^{(i)} \neq 0$ only for support vectors, making predictions involves computing the dot product of the new input vector $\mathbf{x}^{(n)}$ with only the support vectors, not all the training instances. Of course, you also need to compute the bias term \widehat{b} , using the same trick ([Equation 5-12](#)).

Equation 5-12. Computing the bias term using the kernel trick

$$\begin{aligned}\hat{b} &= \frac{1}{n_s} \sum_{\substack{i=1 \\ \hat{\alpha}^{(i)} > 0}}^m \left(t^{(i)} - \hat{\mathbf{w}}^T \phi(\mathbf{x}^{(i)}) \right) = \frac{1}{n_s} \sum_{\substack{i=1 \\ \hat{\alpha}^{(i)} > 0}}^m \left(t^{(i)} - \left(\sum_{j=1}^m \hat{\alpha}^{(j)} t^{(j)} \phi(\mathbf{x}^{(j)}) \right)^T \phi(\mathbf{x}^{(i)}) \right) \\ &= \frac{1}{n_s} \sum_{\substack{i=1 \\ \hat{\alpha}^{(i)} > 0}}^m \left(t^{(i)} - \sum_{\substack{j=1 \\ \hat{\alpha}^{(j)} > 0}}^m \hat{\alpha}^{(j)} t^{(j)} K(\mathbf{x}^{(i)}, \mathbf{x}^{(j)}) \right)\end{aligned}$$

If you are starting to get a headache, it's perfectly normal: it's an unfortunate side effect of the kernel trick.

Online SVMs

Before concluding this chapter, let's take a quick look at online SVM classifiers (recall that online learning means learning incrementally, typically as new instances arrive).

For linear SVM classifiers, one method is to use Gradient Descent (e.g., using `SGDClassifier`) to minimize the cost function in [Equation 5-13](#), which is derived from the primal problem. Unfortunately it converges much more slowly than the methods based on QP.

Equation 5-13. Linear SVM classifier cost function

$$J(\mathbf{w}, b) = \frac{1}{2} \mathbf{w}^T \mathbf{w} + C \sum_{i=1}^m \max(0, 1 - t^{(i)}(\mathbf{w}^T \mathbf{x}^{(i)} + b))$$

The first sum in the cost function will push the model to have a small weight vector \mathbf{w} , leading to a larger margin. The second sum computes the total of all margin violations. An instance's margin violation is equal to 0 if it is located off the street and on the correct side, or else it is proportional to the distance to the correct side of the street. Minimizing this term ensures that the model makes the margin violations as small and as few as possible

Hinge Loss

The function $\max(0, 1 - t)$ is called the *hinge loss* function (represented below). It is equal to 0 when $t \geq 1$. Its derivative (slope) is equal to -1 if $t < 1$ and 0 if $t > 1$. It is not differentiable at $t = 1$, but just like for Lasso Regression (see [“Lasso Regression” on page 139](#)) you can still use Gradient Descent using any *subderivative* at $t = 1$ (i.e., any value between -1 and 0).

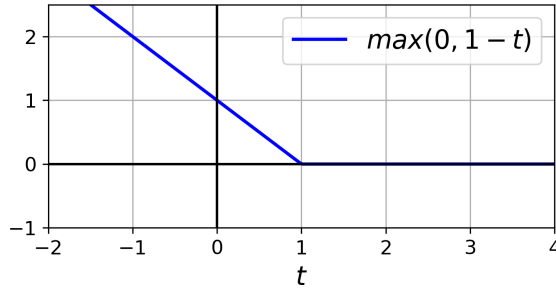

It is also possible to implement online kernelized SVMs—for example, using “[Incremental and Decremental SVM Learning](#)”⁸ or “[Fast Kernel Classifiers with Online and Active Learning](#).”⁹ However, these are implemented in Matlab and C++. For large-scale nonlinear problems, you may want to consider using neural networks instead (see [Part II](#)).

Exercises

1. What is the fundamental idea behind Support Vector Machines?
2. What is a support vector?
3. Why is it important to scale the inputs when using SVMs?
4. Can an SVM classifier output a confidence score when it classifies an instance? What about a probability?
5. Should you use the primal or the dual form of the SVM problem to train a model on a training set with millions of instances and hundreds of features?
6. Say you trained an SVM classifier with an RBF kernel. It seems to underfit the training set: should you increase or decrease γ (gamma)? What about C ?
7. How should you set the QP parameters (\mathbf{H} , \mathbf{f} , \mathbf{A} , and \mathbf{b}) to solve the soft margin linear SVM classifier problem using an off-the-shelf QP solver?
8. Train a `LinearSVC` on a linearly separable dataset. Then train an `SVC` and a `SGDClassifier` on the same dataset. See if you can get them to produce roughly the same model.
9. Train an SVM classifier on the MNIST dataset. Since SVM classifiers are binary classifiers, you will need to use one-versus-all to classify all 10 digits. You may

⁸ “Incremental and Decremental Support Vector Machine Learning,” G. Cauwenberghs, T. Poggio (2001).

⁹ “Fast Kernel Classifiers with Online and Active Learning,” A. Bordes, S. Ertekin, J. Weston, L. Bottou (2005).

want to tune the hyperparameters using small validation sets to speed up the process. What accuracy can you reach?

10. Train an SVM regressor on the California housing dataset.

Solutions to these exercises are available in ???.

Decision Trees



With Early Release ebooks, you get books in their earliest form—the author’s raw and unedited content as he or she writes—so you can take advantage of these technologies long before the official release of these titles. The following will be Chapter 6 in the final release of the book.

Like SVMs, *Decision Trees* are versatile Machine Learning algorithms that can perform both classification and regression tasks, and even multioutput tasks. They are very powerful algorithms, capable of fitting complex datasets. For example, in [Chapter 2](#) you trained a `DecisionTreeRegressor` model on the California housing dataset, fitting it perfectly (actually overfitting it).

Decision Trees are also the fundamental components of Random Forests (see [Chapter 7](#)), which are among the most powerful Machine Learning algorithms available today.

In this chapter we will start by discussing how to train, visualize, and make predictions with Decision Trees. Then we will go through the CART training algorithm used by Scikit-Learn, and we will discuss how to regularize trees and use them for regression tasks. Finally, we will discuss some of the limitations of Decision Trees.

Training and Visualizing a Decision Tree

To understand Decision Trees, let’s just build one and take a look at how it makes predictions. The following code trains a `DecisionTreeClassifier` on the iris dataset (see [Chapter 4](#)):

```
from sklearn.datasets import load_iris
from sklearn.tree import DecisionTreeClassifier
```

```
iris = load_iris()
X = iris.data[:, 2:] # petal length and width
y = iris.target

tree_clf = DecisionTreeClassifier(max_depth=2)
tree_clf.fit(X, y)
```

You can visualize the trained Decision Tree by first using the `export_graphviz()` method to output a graph definition file called `iris_tree.dot`:

```
from sklearn.tree import export_graphviz

export_graphviz(
    tree_clf,
    out_file=image_path("iris_tree.dot"),
    feature_names=iris.feature_names[2:],
    class_names=iris.target_names,
    rounded=True,
    filled=True
)
```

Then you can convert this `.dot` file to a variety of formats such as PDF or PNG using the `dot` command-line tool from the `graphviz` package.¹ This command line converts the `.dot` file to a `.png` image file:

```
$ dot -Tpng iris_tree.dot -o iris_tree.png
```

Your first decision tree looks like [Figure 6-1](#).

¹ Graphviz is an open source graph visualization software package, available at <http://www.graphviz.org/>.

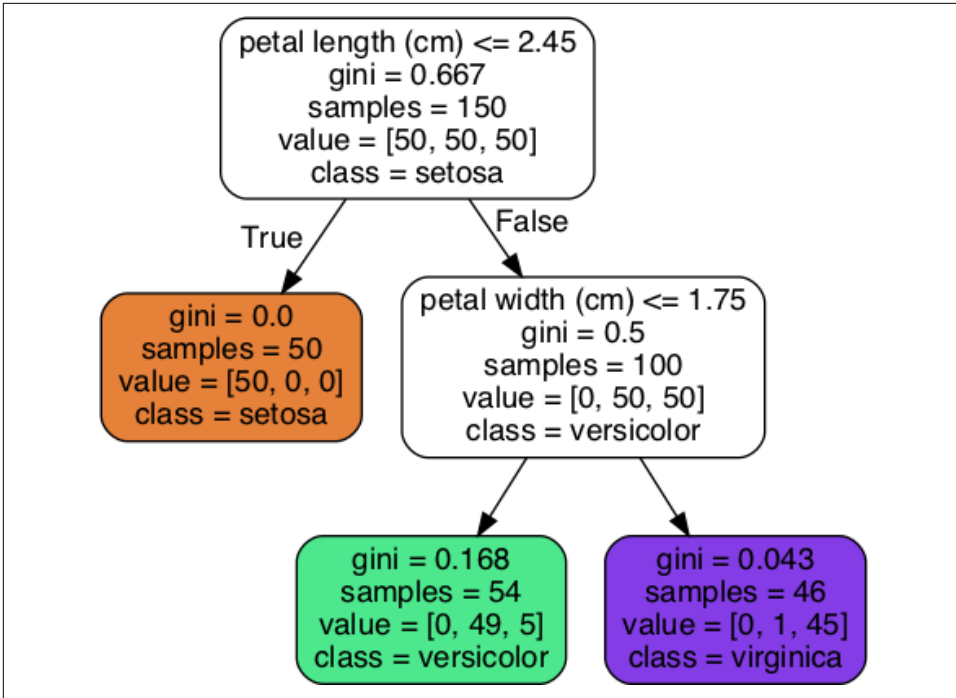

Figure 6-1. Iris Decision Tree

Making Predictions

Let's see how the tree represented in [Figure 6-1](#) makes predictions. Suppose you find an iris flower and you want to classify it. You start at the *root node* (depth 0, at the top): this node asks whether the flower's petal length is smaller than 2.45 cm. If it is, then you move down to the root's left child node (depth 1, left). In this case, it is a *leaf node* (i.e., it does not have any children nodes), so it does not ask any questions: you can simply look at the predicted class for that node and the Decision Tree predicts that your flower is an Iris-Setosa (`class=setosa`).

Now suppose you find another flower, but this time the petal length is greater than 2.45 cm. You must move down to the root's right child node (depth 1, right), which is not a leaf node, so it asks another question: is the petal width smaller than 1.75 cm? If it is, then your flower is most likely an Iris-Versicolor (depth 2, left). If not, it is likely an Iris-Virginica (depth 2, right). It's really that simple.



One of the many qualities of Decision Trees is that they require very little data preparation. In particular, they don't require feature scaling or centering at all.

A node's samples attribute counts how many training instances it applies to. For example, 100 training instances have a petal length greater than 2.45 cm (depth 1, right), among which 54 have a petal width smaller than 1.75 cm (depth 2, left). A node's value attribute tells you how many training instances of each class this node applies to: for example, the bottom-right node applies to 0 Iris-Setosa, 1 Iris-Versicolor, and 45 Iris-Virginica. Finally, a node's gini attribute measures its *impurity*: a node is “pure” (gini=0) if all training instances it applies to belong to the same class. For example, since the depth-1 left node applies only to Iris-Setosa training instances, it is pure and its gini score is 0. Equation 6-1 shows how the training algorithm computes the gini score G_i of the i^{th} node. For example, the depth-2 left node has a gini score equal to $1 - (0/54)^2 - (49/54)^2 - (5/54)^2 \approx 0.168$. Another *impurity measure* is discussed shortly.

Equation 6-1. Gini impurity

$$G_i = 1 - \sum_{k=1}^n p_{i,k}^2$$

- $p_{i,k}$ is the ratio of class k instances among the training instances in the i^{th} node.



Scikit-Learn uses the CART algorithm, which produces only *binary trees*: nonleaf nodes always have two children (i.e., questions only have yes/no answers). However, other algorithms such as ID3 can produce Decision Trees with nodes that have more than two children.

Figure 6-2 shows this Decision Tree's decision boundaries. The thick vertical line represents the decision boundary of the root node (depth 0): petal length = 2.45 cm. Since the left area is pure (only Iris-Setosa), it cannot be split any further. However, the right area is impure, so the depth-1 right node splits it at petal width = 1.75 cm (represented by the dashed line). Since `max_depth` was set to 2, the Decision Tree stops right there. However, if you set `max_depth` to 3, then the two depth-2 nodes would each add another decision boundary (represented by the dotted lines).

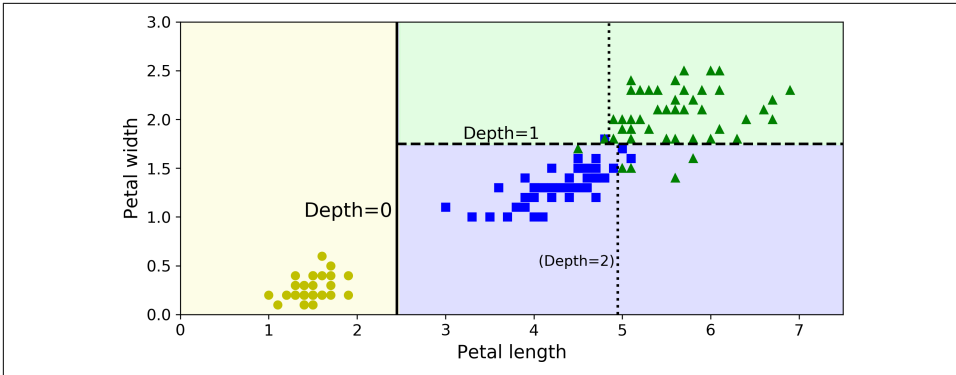

Figure 6-2. Decision Tree decision boundaries

Model Interpretation: White Box Versus Black Box

As you can see Decision Trees are fairly intuitive and their decisions are easy to interpret. Such models are often called *white box models*. In contrast, as we will see, Random Forests or neural networks are generally considered *black box models*. They make great predictions, and you can easily check the calculations that they performed to make these predictions; nevertheless, it is usually hard to explain in simple terms why the predictions were made. For example, if a neural network says that a particular person appears on a picture, it is hard to know what actually contributed to this prediction: did the model recognize that person's eyes? Her mouth? Her nose? Her shoes? Or even the couch that she was sitting on? Conversely, Decision Trees provide nice and simple classification rules that can even be applied manually if need be (e.g., for flower classification).

Estimating Class Probabilities

A Decision Tree can also estimate the probability that an instance belongs to a particular class k : first it traverses the tree to find the leaf node for this instance, and then it returns the ratio of training instances of class k in this node. For example, suppose you have found a flower whose petals are 5 cm long and 1.5 cm wide. The corresponding leaf node is the depth-2 left node, so the Decision Tree should output the following probabilities: 0% for Iris-Setosa (0/54), 90.7% for Iris-Versicolor (49/54), and 9.3% for Iris-Virginica (5/54). And of course if you ask it to predict the class, it should output Iris-Versicolor (class 1) since it has the highest probability. Let's check this:

```
>>> tree_clf.predict_proba([[5, 1.5]])
array([[0.         , 0.90740741, 0.09259259]])
```

```
>>> tree_clf.predict([[5, 1.5]])
array([1])
```

Perfect! Notice that the estimated probabilities would be identical anywhere else in the bottom-right rectangle of [Figure 6-2](#)—for example, if the petals were 6 cm long and 1.5 cm wide (even though it seems obvious that it would most likely be an Iris-Virginica in this case).

The CART Training Algorithm

Scikit-Learn uses the *Classification And Regression Tree* (CART) algorithm to train Decision Trees (also called “growing” trees). The idea is really quite simple: the algorithm first splits the training set in two subsets using a single feature k and a threshold t_k (e.g., “petal length ≤ 2.45 cm”). How does it choose k and t_k ? It searches for the pair (k, t_k) that produces the purest subsets (weighted by their size). The cost function that the algorithm tries to minimize is given by [Equation 6-2](#).

Equation 6-2. CART cost function for classification

$$J(k, t_k) = \frac{m_{\text{left}}}{m} G_{\text{left}} + \frac{m_{\text{right}}}{m} G_{\text{right}}$$

where $\begin{cases} G_{\text{left/right}} & \text{measures the impurity of the left/right subset,} \\ m_{\text{left/right}} & \text{is the number of instances in the left/right subset.} \end{cases}$

Once it has successfully split the training set in two, it splits the subsets using the same logic, then the sub-subsets and so on, recursively. It stops recursing once it reaches the maximum depth (defined by the `max_depth` hyperparameter), or if it cannot find a split that will reduce impurity. A few other hyperparameters (described in a moment) control additional stopping conditions (`min_samples_split`, `min_samples_leaf`, `min_weight_fraction_leaf`, and `max_leaf_nodes`).



As you can see, the CART algorithm is a *greedy algorithm*: it greedily searches for an optimum split at the top level, then repeats the process at each level. It does not check whether or not the split will lead to the lowest possible impurity several levels down. A greedy algorithm often produces a reasonably good solution, but it is not guaranteed to be the optimal solution.

Unfortunately, finding the optimal tree is known to be an *NP-Complete* problem:² it requires $O(\exp(m))$ time, making the problem intractable even for fairly small training sets. This is why we must settle for a “reasonably good” solution.

Computational Complexity

Making predictions requires traversing the Decision Tree from the root to a leaf. Decision Trees are generally approximately balanced, so traversing the Decision Tree requires going through roughly $O(\log_2(m))$ nodes.³ Since each node only requires checking the value of one feature, the overall prediction complexity is just $O(\log_2(m))$, independent of the number of features. So predictions are very fast, even when dealing with large training sets.

However, the training algorithm compares all features (or less if `max_features` is set) on all samples at each node. This results in a training complexity of $O(n \times m \log(m))$. For small training sets (less than a few thousand instances), Scikit-Learn can speed up training by presorting the data (set `presort=True`), but this slows down training considerably for larger training sets.

Gini Impurity or Entropy?

By default, the Gini impurity measure is used, but you can select the *entropy* impurity measure instead by setting the `criterion` hyperparameter to "entropy". The concept of entropy originated in thermodynamics as a measure of molecular disorder: entropy approaches zero when molecules are still and well ordered. It later spread to a wide variety of domains, including Shannon's *information theory*, where it measures the average information content of a message:⁴ entropy is zero when all messages are identical. In Machine Learning, it is frequently used as an impurity measure: a set's

² P is the set of problems that can be solved in polynomial time. NP is the set of problems whose solutions can be verified in polynomial time. An NP-Hard problem is a problem to which any NP problem can be reduced in polynomial time. An NP-Complete problem is both NP and NP-Hard. A major open mathematical question is whether or not $P = NP$. If $P \neq NP$ (which seems likely), then no polynomial algorithm will ever be found for any NP-Complete problem (except perhaps on a quantum computer).

³ \log_2 is the binary logarithm. It is equal to $\log_2(m) = \log(m) / \log(2)$.

⁴ A reduction of entropy is often called an *information gain*.

entropy is zero when it contains instances of only one class. Equation 6-3 shows the definition of the entropy of the i^{th} node. For example, the depth-2 left node in Figure 6-1 has an entropy equal to $-\frac{49}{54} \log_2 \left(\frac{49}{54}\right) - \frac{5}{54} \log_2 \left(\frac{5}{54}\right) \approx 0.445$.

Equation 6-3. Entropy

$$H_i = - \sum_{\substack{k=1 \\ p_{i,k} \neq 0}}^n p_{i,k} \log_2 (p_{i,k})$$

So should you use Gini impurity or entropy? The truth is, most of the time it does not make a big difference: they lead to similar trees. Gini impurity is slightly faster to compute, so it is a good default. However, when they differ, Gini impurity tends to isolate the most frequent class in its own branch of the tree, while entropy tends to produce slightly more balanced trees.⁵

Regularization Hyperparameters

Decision Trees make very few assumptions about the training data (as opposed to linear models, which obviously assume that the data is linear, for example). If left unconstrained, the tree structure will adapt itself to the training data, fitting it very closely, and most likely overfitting it. Such a model is often called a *nonparametric model*, not because it does not have any parameters (it often has a lot) but because the number of parameters is not determined prior to training, so the model structure is free to stick closely to the data. In contrast, a *parametric model* such as a linear model has a predetermined number of parameters, so its degree of freedom is limited, reducing the risk of overfitting (but increasing the risk of underfitting).

To avoid overfitting the training data, you need to restrict the Decision Tree's freedom during training. As you know by now, this is called regularization. The regularization hyperparameters depend on the algorithm used, but generally you can at least restrict the maximum depth of the Decision Tree. In Scikit-Learn, this is controlled by the `max_depth` hyperparameter (the default value is `None`, which means unlimited). Reducing `max_depth` will regularize the model and thus reduce the risk of overfitting.

The `DecisionTreeClassifier` class has a few other parameters that similarly restrict the shape of the Decision Tree: `min_samples_split` (the minimum number of samples a node must have before it can be split), `min_samples_leaf` (the minimum number of samples a leaf node must have), `min_weight_fraction_leaf` (same as `min_samples_leaf` but expressed as a fraction of the total number of weighted

⁵ See Sebastian Raschka's [interesting analysis for more details](#).

instances), `max_leaf_nodes` (maximum number of leaf nodes), and `max_features` (maximum number of features that are evaluated for splitting at each node). Increasing `min_*` hyperparameters or reducing `max_*` hyperparameters will regularize the model.



Other algorithms work by first training the Decision Tree without restrictions, then *pruning* (deleting) unnecessary nodes. A node whose children are all leaf nodes is considered unnecessary if the purity improvement it provides is not *statistically significant*. Standard statistical tests, such as the χ^2 test, are used to estimate the probability that the improvement is purely the result of chance (which is called the *null hypothesis*). If this probability, called the *p-value*, is higher than a given threshold (typically 5%, controlled by a hyperparameter), then the node is considered unnecessary and its children are deleted. The pruning continues until all unnecessary nodes have been pruned.

Figure 6-3 shows two Decision Trees trained on the moons dataset (introduced in Chapter 5). On the left, the Decision Tree is trained with the default hyperparameters (i.e., no restrictions), and on the right the Decision Tree is trained with `min_samples_leaf=4`. It is quite obvious that the model on the left is overfitting, and the model on the right will probably generalize better.

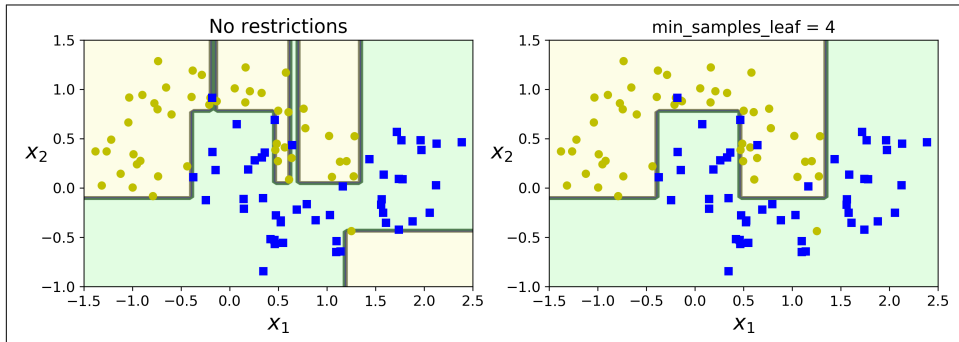

Figure 6-3. Regularization using `min_samples_leaf`

Regression

Decision Trees are also capable of performing regression tasks. Let's build a regression tree using Scikit-Learn's `DecisionTreeRegressor` class, training it on a noisy quadratic dataset with `max_depth=2`:

```
from sklearn.tree import DecisionTreeRegressor
```

```
tree_reg = DecisionTreeRegressor(max_depth=2)
tree_reg.fit(X, y)
```

The resulting tree is represented on [Figure 6-4](#).

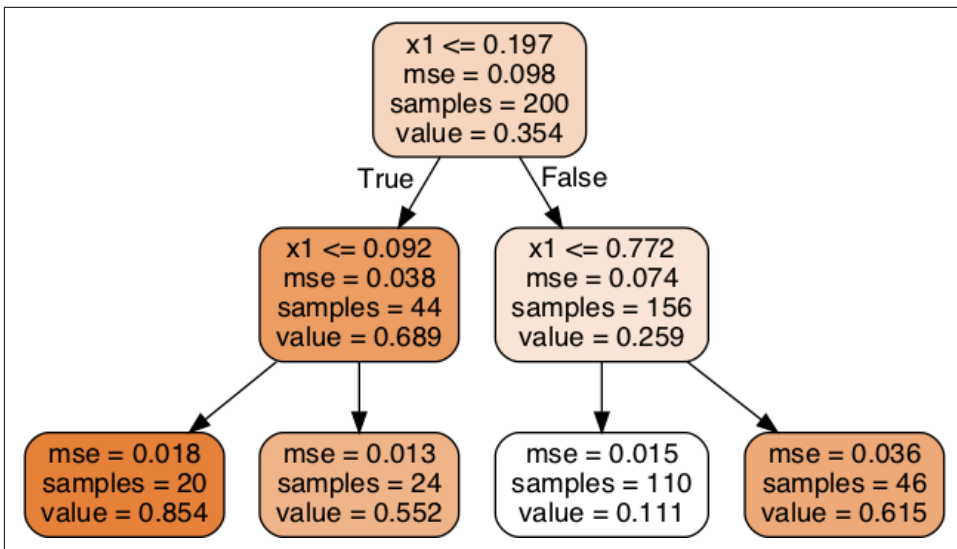

Figure 6-4. A Decision Tree for regression

This tree looks very similar to the classification tree you built earlier. The main difference is that instead of predicting a class in each node, it predicts a value. For example, suppose you want to make a prediction for a new instance with $x_1 = 0.6$. You traverse the tree starting at the root, and you eventually reach the leaf node that predicts $\text{value}=0.1106$. This prediction is simply the average target value of the 110 training instances associated to this leaf node. This prediction results in a Mean Squared Error (MSE) equal to 0.0151 over these 110 instances.

This model's predictions are represented on the left of [Figure 6-5](#). If you set `max_depth=3`, you get the predictions represented on the right. Notice how the predicted value for each region is always the average target value of the instances in that region. The algorithm splits each region in a way that makes most training instances as close as possible to that predicted value.

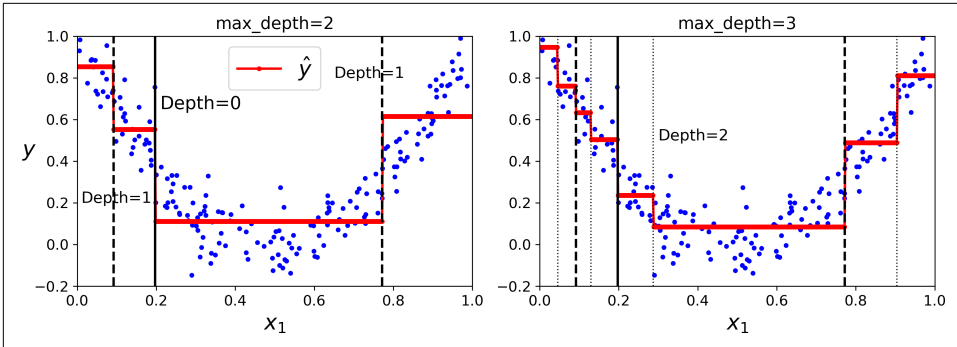

Figure 6-5. Predictions of two Decision Tree regression models

The CART algorithm works mostly the same way as earlier, except that instead of trying to split the training set in a way that minimizes impurity, it now tries to split the training set in a way that minimizes the MSE. Equation 6-4 shows the cost function that the algorithm tries to minimize.

Equation 6-4. CART cost function for regression

$$J(k, t_k) = \frac{m_{\text{left}}}{m} \text{MSE}_{\text{left}} + \frac{m_{\text{right}}}{m} \text{MSE}_{\text{right}} \quad \text{where} \quad \begin{cases} \text{MSE}_{\text{node}} = \sum_{i \in \text{node}} (\hat{y}_{\text{node}} - y^{(i)})^2 \\ \hat{y}_{\text{node}} = \frac{1}{m_{\text{node}}} \sum_{i \in \text{node}} y^{(i)} \end{cases}$$

Just like for classification tasks, Decision Trees are prone to overfitting when dealing with regression tasks. Without any regularization (i.e., using the default hyperparameters), you get the predictions on the left of Figure 6-6. It is obviously overfitting the training set very badly. Just setting `min_samples_leaf=10` results in a much more reasonable model, represented on the right of Figure 6-6.

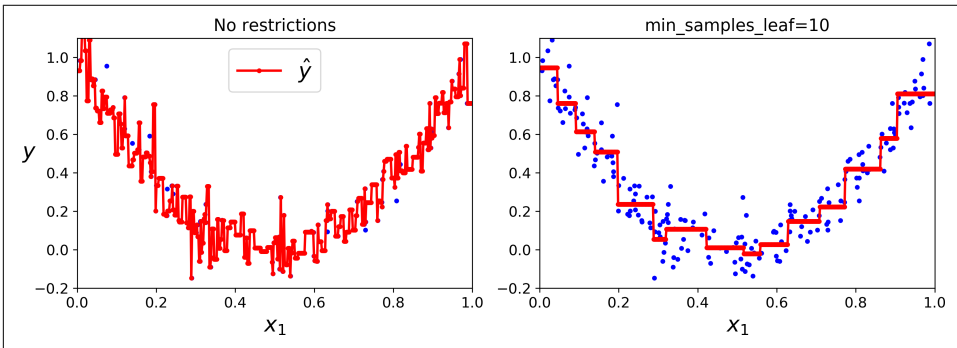

Figure 6-6. Regularizing a Decision Tree regressor

Instability

Hopefully by now you are convinced that Decision Trees have a lot going for them: they are simple to understand and interpret, easy to use, versatile, and powerful. However they do have a few limitations. First, as you may have noticed, Decision Trees love orthogonal decision boundaries (all splits are perpendicular to an axis), which makes them sensitive to training set rotation. For example, [Figure 6-7](#) shows a simple linearly separable dataset: on the left, a Decision Tree can split it easily, while on the right, after the dataset is rotated by 45°, the decision boundary looks unnecessarily convoluted. Although both Decision Trees fit the training set perfectly, it is very likely that the model on the right will not generalize well. One way to limit this problem is to use PCA (see [Chapter 8](#)), which often results in a better orientation of the training data.

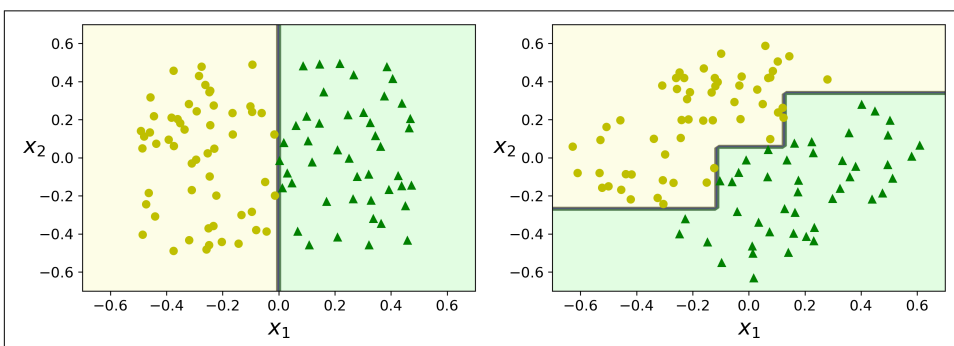

Figure 6-7. Sensitivity to training set rotation

More generally, the main issue with Decision Trees is that they are very sensitive to small variations in the training data. For example, if you just remove the widest Iris-Versicolor from the iris training set (the one with petals 4.8 cm long and 1.8 cm wide) and train a new Decision Tree, you may get the model represented in [Figure 6-8](#). As you can see, it looks very different from the previous Decision Tree ([Figure 6-2](#)). Actually, since the training algorithm used by Scikit-Learn is stochastic⁶ you may get very different models even on the same training data (unless you set the `random_state` hyperparameter).

⁶ It randomly selects the set of features to evaluate at each node.

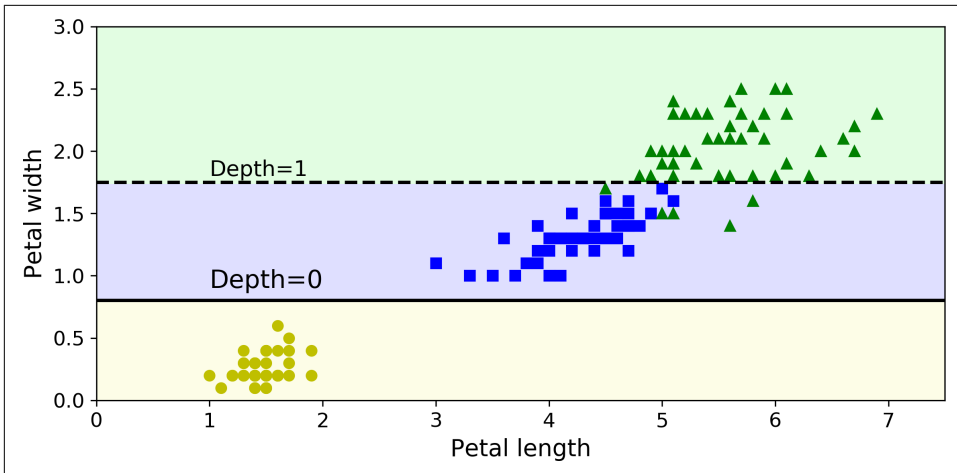

Figure 6-8. Sensitivity to training set details

Random Forests can limit this instability by averaging predictions over many trees, as we will see in the next chapter.

Exercises

1. What is the approximate depth of a Decision Tree trained (without restrictions) on a training set with 1 million instances?
2. Is a node's Gini impurity generally lower or greater than its parent's? Is it *generally* lower/greater, or *always* lower/greater?
3. If a Decision Tree is overfitting the training set, is it a good idea to try decreasing `max_depth`?
4. If a Decision Tree is underfitting the training set, is it a good idea to try scaling the input features?
5. If it takes one hour to train a Decision Tree on a training set containing 1 million instances, roughly how much time will it take to train another Decision Tree on a training set containing 10 million instances?
6. If your training set contains 100,000 instances, will setting `presort=True` speed up training?
7. Train and fine-tune a Decision Tree for the moons dataset.
 - a. Generate a moons dataset using `make_moons(n_samples=10000, noise=0.4)`.
 - b. Split it into a training set and a test set using `train_test_split()`.

- c. Use grid search with cross-validation (with the help of the `GridSearchCV` class) to find good hyperparameter values for a `DecisionTreeClassifier`. Hint: try various values for `max_leaf_nodes`.
 - d. Train it on the full training set using these hyperparameters, and measure your model's performance on the test set. You should get roughly 85% to 87% accuracy.
8. Grow a forest.
- a. Continuing the previous exercise, generate 1,000 subsets of the training set, each containing 100 instances selected randomly. Hint: you can use Scikit-Learn's `ShuffleSplit` class for this.
 - b. Train one Decision Tree on each subset, using the best hyperparameter values found above. Evaluate these 1,000 Decision Trees on the test set. Since they were trained on smaller sets, these Decision Trees will likely perform worse than the first Decision Tree, achieving only about 80% accuracy.
 - c. Now comes the magic. For each test set instance, generate the predictions of the 1,000 Decision Trees, and keep only the most frequent prediction (you can use SciPy's `mode()` function for this). This gives you *majority-vote predictions* over the test set.
 - d. Evaluate these predictions on the test set: you should obtain a slightly higher accuracy than your first model (about 0.5 to 1.5% higher). Congratulations, you have trained a Random Forest classifier!

Solutions to these exercises are available in ???.

Ensemble Learning and Random Forests



With Early Release ebooks, you get books in their earliest form—the author’s raw and unedited content as he or she writes—so you can take advantage of these technologies long before the official release of these titles. The following will be Chapter 7 in the final release of the book.

Suppose you ask a complex question to thousands of random people, then aggregate their answers. In many cases you will find that this aggregated answer is better than an expert’s answer. This is called the *wisdom of the crowd*. Similarly, if you aggregate the predictions of a group of predictors (such as classifiers or regressors), you will often get better predictions than with the best individual predictor. A group of predictors is called an *ensemble*; thus, this technique is called *Ensemble Learning*, and an Ensemble Learning algorithm is called an *Ensemble method*.

For example, you can train a group of Decision Tree classifiers, each on a different random subset of the training set. To make predictions, you just obtain the predictions of all individual trees, then predict the class that gets the most votes (see the last exercise in [Chapter 6](#)). Such an ensemble of Decision Trees is called a *Random Forest*, and despite its simplicity, this is one of the most powerful Machine Learning algorithms available today.

Moreover, as we discussed in [Chapter 2](#), you will often use Ensemble methods near the end of a project, once you have already built a few good predictors, to combine them into an even better predictor. In fact, the winning solutions in Machine Learning competitions often involve several Ensemble methods (most famously in the [Netflix Prize competition](#)).

In this chapter we will discuss the most popular Ensemble methods, including *bagging*, *boosting*, *stacking*, and a few others. We will also explore Random Forests.

Voting Classifiers

Suppose you have trained a few classifiers, each one achieving about 80% accuracy. You may have a Logistic Regression classifier, an SVM classifier, a Random Forest classifier, a K-Nearest Neighbors classifier, and perhaps a few more (see [Figure 7-1](#)).

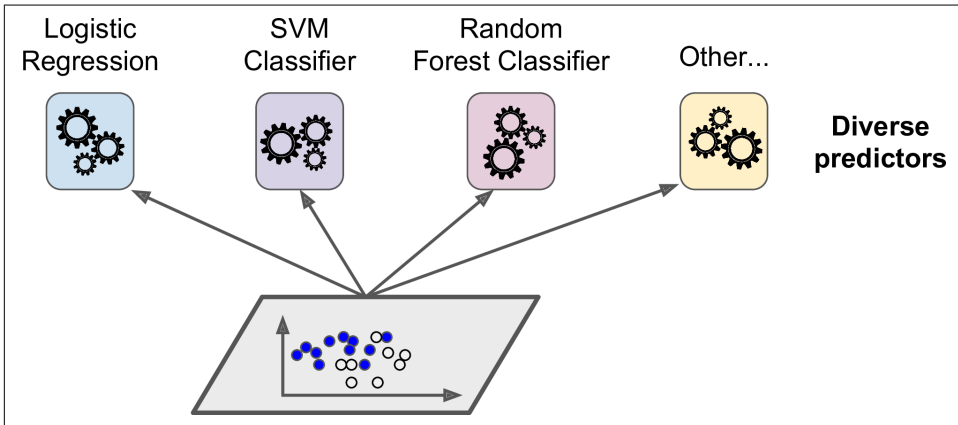

Figure 7-1. Training diverse classifiers

A very simple way to create an even better classifier is to aggregate the predictions of each classifier and predict the class that gets the most votes. This majority-vote classifier is called a *hard voting* classifier (see [Figure 7-2](#)).

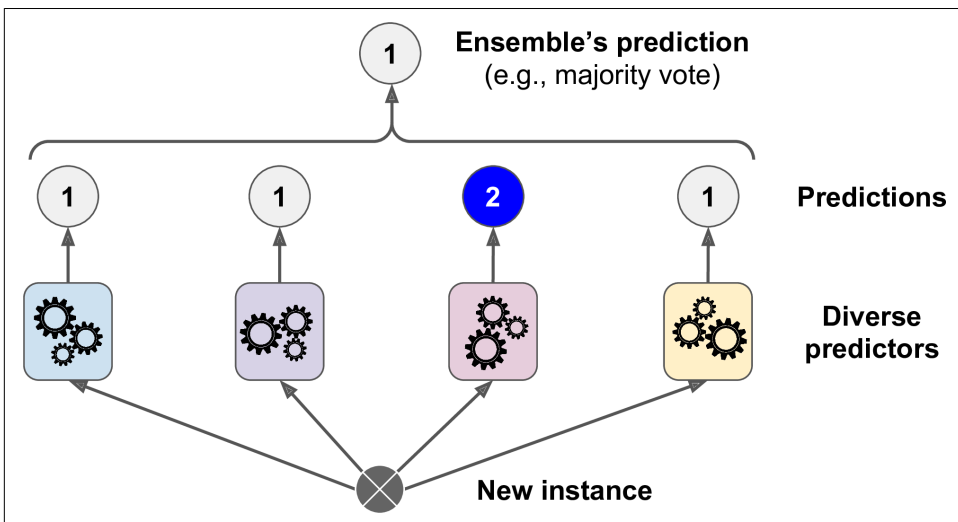

Figure 7-2. Hard voting classifier predictions

Somewhat surprisingly, this voting classifier often achieves a higher accuracy than the best classifier in the ensemble. In fact, even if each classifier is a *weak learner* (meaning it does only slightly better than random guessing), the ensemble can still be a *strong learner* (achieving high accuracy), provided there are a sufficient number of weak learners and they are sufficiently diverse.

How is this possible? The following analogy can help shed some light on this mystery. Suppose you have a slightly biased coin that has a 51% chance of coming up heads, and 49% chance of coming up tails. If you toss it 1,000 times, you will generally get more or less 510 heads and 490 tails, and hence a majority of heads. If you do the math, you will find that the probability of obtaining a majority of heads after 1,000 tosses is close to 75%. The more you toss the coin, the higher the probability (e.g., with 10,000 tosses, the probability climbs over 97%). This is due to the *law of large numbers*: as you keep tossing the coin, the ratio of heads gets closer and closer to the probability of heads (51%). **Figure 7-3** shows 10 series of biased coin tosses. You can see that as the number of tosses increases, the ratio of heads approaches 51%. Eventually all 10 series end up so close to 51% that they are consistently above 50%.

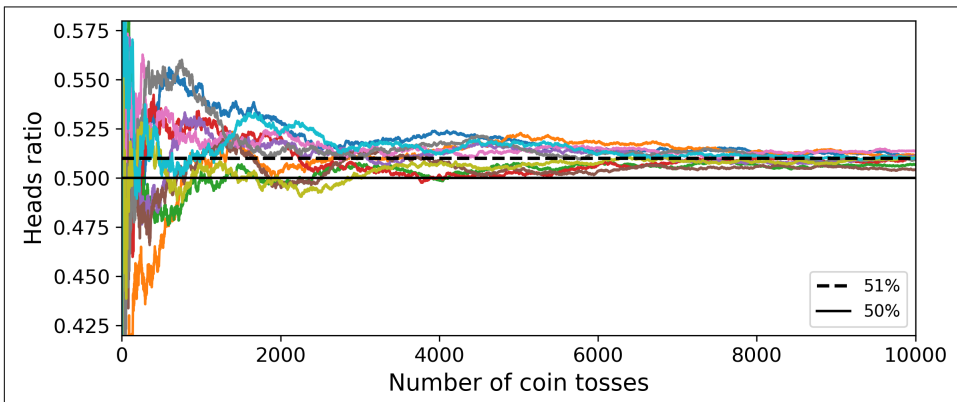

Figure 7-3. The law of large numbers

Similarly, suppose you build an ensemble containing 1,000 classifiers that are individually correct only 51% of the time (barely better than random guessing). If you predict the majority voted class, you can hope for up to 75% accuracy! However, this is only true if all classifiers are perfectly independent, making uncorrelated errors, which is clearly not the case since they are trained on the same data. They are likely to make the same types of errors, so there will be many majority votes for the wrong class, reducing the ensemble's accuracy.



Ensemble methods work best when the predictors are as independent from one another as possible. One way to get diverse classifiers is to train them using very different algorithms. This increases the chance that they will make very different types of errors, improving the ensemble's accuracy.

The following code creates and trains a voting classifier in Scikit-Learn, composed of three diverse classifiers (the training set is the moons dataset, introduced in [Chapter 5](#)):

```
from sklearn.ensemble import RandomForestClassifier
from sklearn.ensemble import VotingClassifier
from sklearn.linear_model import LogisticRegression
from sklearn.svm import SVC

log_clf = LogisticRegression()
rnd_clf = RandomForestClassifier()
svm_clf = SVC()

voting_clf = VotingClassifier(
    estimators=[('lr', log_clf), ('rf', rnd_clf), ('svc', svm_clf)],
    voting='hard')
voting_clf.fit(X_train, y_train)
```

Let's look at each classifier's accuracy on the test set:

```
>>> from sklearn.metrics import accuracy_score
>>> for clf in (log_clf, rnd_clf, svm_clf, voting_clf):
...     clf.fit(X_train, y_train)
...     y_pred = clf.predict(X_test)
...     print(clf.__class__.__name__, accuracy_score(y_test, y_pred))
...
LogisticRegression 0.864
RandomForestClassifier 0.896
SVC 0.888
VotingClassifier 0.904
```

There you have it! The voting classifier slightly outperforms all the individual classifiers.

If all classifiers are able to estimate class probabilities (i.e., they have a `predict_proba()` method), then you can tell Scikit-Learn to predict the class with the highest class probability, averaged over all the individual classifiers. This is called *soft voting*. It often achieves higher performance than hard voting because it gives more weight to highly confident votes. All you need to do is replace `voting="hard"` with `voting="soft"` and ensure that all classifiers can estimate class probabilities. This is not the case of the SVC class by default, so you need to set its `probability` hyperparameter to `True` (this will make the SVC class use cross-validation to estimate class probabilities, slowing down training, and it will add a `predict_proba()` method). If you

modify the preceding code to use soft voting, you will find that the voting classifier achieves over 91.2% accuracy!

Bagging and Pasting

One way to get a diverse set of classifiers is to use very different training algorithms, as just discussed. Another approach is to use the same training algorithm for every predictor, but to train them on different random subsets of the training set. When sampling is performed *with* replacement, this method is called *bagging*¹ (short for *bootstrap aggregating*²). When sampling is performed *without* replacement, it is called *pasting*.³

In other words, both bagging and pasting allow training instances to be sampled several times across multiple predictors, but only bagging allows training instances to be sampled several times for the same predictor. This sampling and training process is represented in [Figure 7-4](#).

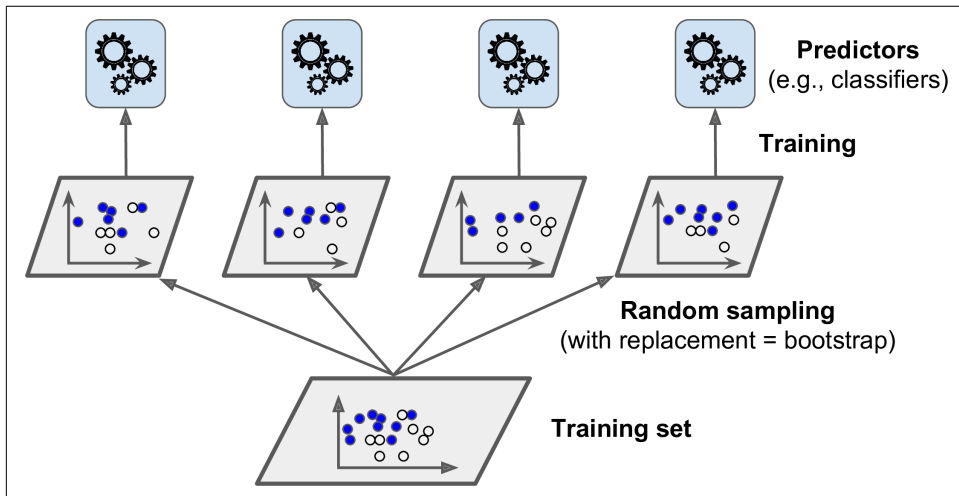

Figure 7-4. Pasting/bagging training set sampling and training

Once all predictors are trained, the ensemble can make a prediction for a new instance by simply aggregating the predictions of all predictors. The aggregation function is typically the *statistical mode* (i.e., the most frequent prediction, just like a hard voting classifier) for classification, or the average for regression. Each individual

¹ “Bagging Predictors,” L. Breiman (1996).

² In statistics, resampling with replacement is called *bootstrapping*.

³ “Pasting small votes for classification in large databases and on-line,” L. Breiman (1999).

predictor has a higher bias than if it were trained on the original training set, but aggregation reduces both bias and variance.⁴ Generally, the net result is that the ensemble has a similar bias but a lower variance than a single predictor trained on the original training set.

As you can see in [Figure 7-4](#), predictors can all be trained in parallel, via different CPU cores or even different servers. Similarly, predictions can be made in parallel. This is one of the reasons why bagging and pasting are such popular methods: they scale very well.

Bagging and Pasting in Scikit-Learn

Scikit-Learn offers a simple API for both bagging and pasting with the `BaggingClassifier` class (or `BaggingRegressor` for regression). The following code trains an ensemble of 500 Decision Tree classifiers,⁵ each trained on 100 training instances randomly sampled from the training set with replacement (this is an example of bagging, but if you want to use pasting instead, just set `bootstrap=False`). The `n_jobs` parameter tells Scikit-Learn the number of CPU cores to use for training and predictions (`-1` tells Scikit-Learn to use all available cores):

```
from sklearn.ensemble import BaggingClassifier
from sklearn.tree import DecisionTreeClassifier

bag_clf = BaggingClassifier(
    DecisionTreeClassifier(), n_estimators=500,
    max_samples=100, bootstrap=True, n_jobs=-1)
bag_clf.fit(X_train, y_train)
y_pred = bag_clf.predict(X_test)
```



The `BaggingClassifier` automatically performs soft voting instead of hard voting if the base classifier can estimate class probabilities (i.e., if it has a `predict_proba()` method), which is the case with Decision Trees classifiers.

[Figure 7-5](#) compares the decision boundary of a single Decision Tree with the decision boundary of a bagging ensemble of 500 trees (from the preceding code), both trained on the moons dataset. As you can see, the ensemble's predictions will likely generalize much better than the single Decision Tree's predictions: the ensemble has a comparable bias but a smaller variance (it makes roughly the same number of errors on the training set, but the decision boundary is less irregular).

⁴ Bias and variance were introduced in [Chapter 4](#).

⁵ `max_samples` can alternatively be set to a float between 0.0 and 1.0, in which case the max number of instances to sample is equal to the size of the training set times `max_samples`.

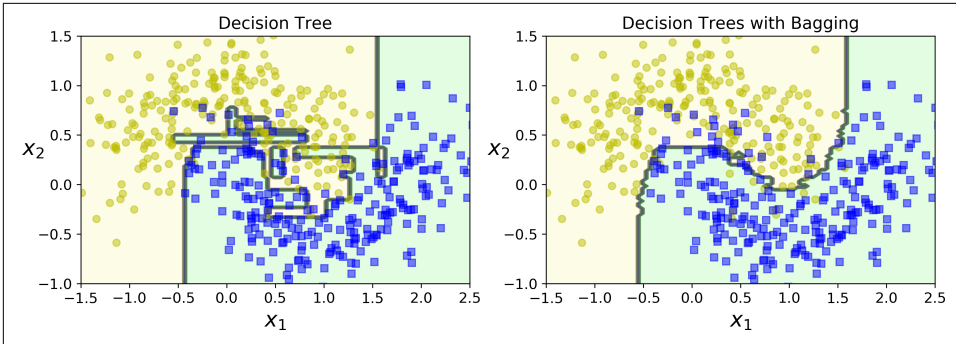

Figure 7-5. A single Decision Tree versus a bagging ensemble of 500 trees

Bootstrapping introduces a bit more diversity in the subsets that each predictor is trained on, so bagging ends up with a slightly higher bias than pasting, but this also means that predictors end up being less correlated so the ensemble’s variance is reduced. Overall, bagging often results in better models, which explains why it is generally preferred. However, if you have spare time and CPU power you can use cross-validation to evaluate both bagging and pasting and select the one that works best.

Out-of-Bag Evaluation

With bagging, some instances may be sampled several times for any given predictor, while others may not be sampled at all. By default a `BaggingClassifier` samples m training instances with replacement (`bootstrap=True`), where m is the size of the training set. This means that only about 63% of the training instances are sampled on average for each predictor.⁶ The remaining 37% of the training instances that are not sampled are called *out-of-bag* (oob) instances. Note that they are not the same 37% for all predictors.

Since a predictor never sees the oob instances during training, it can be evaluated on these instances, without the need for a separate validation set. You can evaluate the ensemble itself by averaging out the oob evaluations of each predictor.

In Scikit-Learn, you can set `oob_score=True` when creating a `BaggingClassifier` to request an automatic oob evaluation after training. The following code demonstrates this. The resulting evaluation score is available through the `oob_score_` variable:

```
>>> bag_clf = BaggingClassifier(
...     DecisionTreeClassifier(), n_estimators=500,
...     bootstrap=True, n_jobs=-1, oob_score=True)
...
>>> bag_clf.fit(X_train, y_train)
```

⁶ As m grows, this ratio approaches $1 - \exp(-1) \approx 63.212\%$.

```
>>> bag_clf.oob_score_  
0.9013333333333332
```

According to this oob evaluation, this `BaggingClassifier` is likely to achieve about 90.1% accuracy on the test set. Let's verify this:

```
>>> from sklearn.metrics import accuracy_score  
>>> y_pred = bag_clf.predict(X_test)  
>>> accuracy_score(y_test, y_pred)  
0.91200000000000003
```

We get 91.2% accuracy on the test set—close enough!

The oob decision function for each training instance is also available through the `oob_decision_function_` variable. In this case (since the base estimator has a `predict_proba()` method) the decision function returns the class probabilities for each training instance. For example, the oob evaluation estimates that the first training instance has a 68.25% probability of belonging to the positive class (and 31.75% of belonging to the negative class):

```
>>> bag_clf.oob_decision_function_  
array([[0.31746032, 0.68253968],  
       [0.34117647, 0.65882353],  
       [1.         , 0.         ],  
       ...  
       [1.         , 0.         ],  
       [0.03108808, 0.96891192],  
       [0.57291667, 0.42708333]])
```

Random Patches and Random Subspaces

The `BaggingClassifier` class supports sampling the features as well. This is controlled by two hyperparameters: `max_features` and `bootstrap_features`. They work the same way as `max_samples` and `bootstrap`, but for feature sampling instead of instance sampling. Thus, each predictor will be trained on a random subset of the input features.

This is particularly useful when you are dealing with high-dimensional inputs (such as images). Sampling both training instances and features is called the *Random Patches method*.⁷ Keeping all training instances (i.e., `bootstrap=False` and `max_samples=1.0`) but sampling features (i.e., `bootstrap_features=True` and/or `max_features` smaller than 1.0) is called the *Random Subspaces method*.⁸

⁷ “Ensembles on Random Patches,” G. Louppe and P. Geurts (2012).

⁸ “The random subspace method for constructing decision forests,” Tin Kam Ho (1998).

Sampling features results in even more predictor diversity, trading a bit more bias for a lower variance.

Random Forests

As we have discussed, a **Random Forest**⁹ is an ensemble of Decision Trees, generally trained via the bagging method (or sometimes pasting), typically with `max_samples` set to the size of the training set. Instead of building a `BaggingClassifier` and passing it a `DecisionTreeClassifier`, you can instead use the `RandomForestClassifier` class, which is more convenient and optimized for Decision Trees¹⁰ (similarly, there is a `RandomForestRegressor` class for regression tasks). The following code trains a Random Forest classifier with 500 trees (each limited to maximum 16 nodes), using all available CPU cores:

```
from sklearn.ensemble import RandomForestClassifier

rnd_clf = RandomForestClassifier(n_estimators=500, max_leaf_nodes=16, n_jobs=-1)
rnd_clf.fit(X_train, y_train)

y_pred_rf = rnd_clf.predict(X_test)
```

With a few exceptions, a `RandomForestClassifier` has all the hyperparameters of a `DecisionTreeClassifier` (to control how trees are grown), plus all the hyperparameters of a `BaggingClassifier` to control the ensemble itself.¹¹

The Random Forest algorithm introduces extra randomness when growing trees; instead of searching for the very best feature when splitting a node (see [Chapter 6](#)), it searches for the best feature among a random subset of features. This results in a greater tree diversity, which (once again) trades a higher bias for a lower variance, generally yielding an overall better model. The following `BaggingClassifier` is roughly equivalent to the previous `RandomForestClassifier`:

```
bag_clf = BaggingClassifier(
    DecisionTreeClassifier(splitter="random", max_leaf_nodes=16),
    n_estimators=500, max_samples=1.0, bootstrap=True, n_jobs=-1)
```

⁹ “Random Decision Forests,” T. Ho (1995).

¹⁰ The `BaggingClassifier` class remains useful if you want a bag of something other than Decision Trees.

¹¹ There are a few notable exceptions: `splitter` is absent (forced to "random"), `presort` is absent (forced to False), `max_samples` is absent (forced to 1.0), and `base_estimator` is absent (forced to `DecisionTreeClassifier` with the provided hyperparameters).

Extra-Trees

When you are growing a tree in a Random Forest, at each node only a random subset of the features is considered for splitting (as discussed earlier). It is possible to make trees even more random by also using random thresholds for each feature rather than searching for the best possible thresholds (like regular Decision Trees do).

A forest of such extremely random trees is simply called an *Extremely Randomized Trees* ensemble¹² (or *Extra-Trees* for short). Once again, this trades more bias for a lower variance. It also makes Extra-Trees much faster to train than regular Random Forests since finding the best possible threshold for each feature at every node is one of the most time-consuming tasks of growing a tree.

You can create an Extra-Trees classifier using Scikit-Learn's `ExtraTreesClassifier` class. Its API is identical to the `RandomForestClassifier` class. Similarly, the `ExtraTreesRegressor` class has the same API as the `RandomForestRegressor` class.



It is hard to tell in advance whether a `RandomForestClassifier` will perform better or worse than an `ExtraTreesClassifier`. Generally, the only way to know is to try both and compare them using cross-validation (and tuning the hyperparameters using grid search).

Feature Importance

Yet another great quality of Random Forests is that they make it easy to measure the relative importance of each feature. Scikit-Learn measures a feature's importance by looking at how much the tree nodes that use that feature reduce impurity on average (across all trees in the forest). More precisely, it is a weighted average, where each node's weight is equal to the number of training samples that are associated with it (see [Chapter 6](#)).

Scikit-Learn computes this score automatically for each feature after training, then it scales the results so that the sum of all importances is equal to 1. You can access the result using the `feature_importances_` variable. For example, the following code trains a `RandomForestClassifier` on the iris dataset (introduced in [Chapter 4](#)) and outputs each feature's importance. It seems that the most important features are the petal length (44%) and width (42%), while sepal length and width are rather unimportant in comparison (11% and 2%, respectively).

¹² "Extremely randomized trees," P. Geurts, D. Ernst, L. Wehenkel (2005).

```

>>> from sklearn.datasets import load_iris
>>> iris = load_iris()
>>> rnd_clf = RandomForestClassifier(n_estimators=500, n_jobs=-1)
>>> rnd_clf.fit(iris["data"], iris["target"])
>>> for name, score in zip(iris["feature_names"], rnd_clf.feature_importances_):
...     print(name, score)
...
sepal length (cm) 0.112492250999
sepal width (cm) 0.0231192882825
petal length (cm) 0.441030464364
petal width (cm) 0.423357996355

```

Similarly, if you train a Random Forest classifier on the MNIST dataset (introduced in [Chapter 3](#)) and plot each pixel's importance, you get the image represented in [Figure 7-6](#).

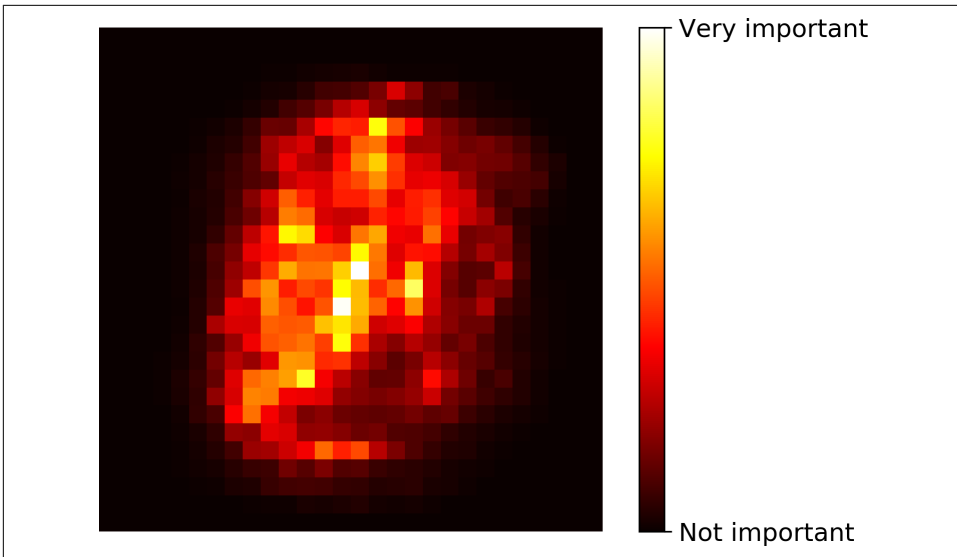

Figure 7-6. MNIST pixel importance (according to a Random Forest classifier)

Random Forests are very handy to get a quick understanding of what features actually matter, in particular if you need to perform feature selection.

Boosting

Boosting (originally called *hypothesis boosting*) refers to any Ensemble method that can combine several weak learners into a strong learner. The general idea of most boosting methods is to train predictors sequentially, each trying to correct its predecessor. There are many boosting methods available, but by far the most popular are

*AdaBoost*¹³ (short for *Adaptive Boosting*) and *Gradient Boosting*. Let's start with AdaBoost.

AdaBoost

One way for a new predictor to correct its predecessor is to pay a bit more attention to the training instances that the predecessor underfitted. This results in new predictors focusing more and more on the hard cases. This is the technique used by AdaBoost.

For example, to build an AdaBoost classifier, a first base classifier (such as a Decision Tree) is trained and used to make predictions on the training set. The relative weight of misclassified training instances is then increased. A second classifier is trained using the updated weights and again it makes predictions on the training set, weights are updated, and so on (see [Figure 7-7](#)).

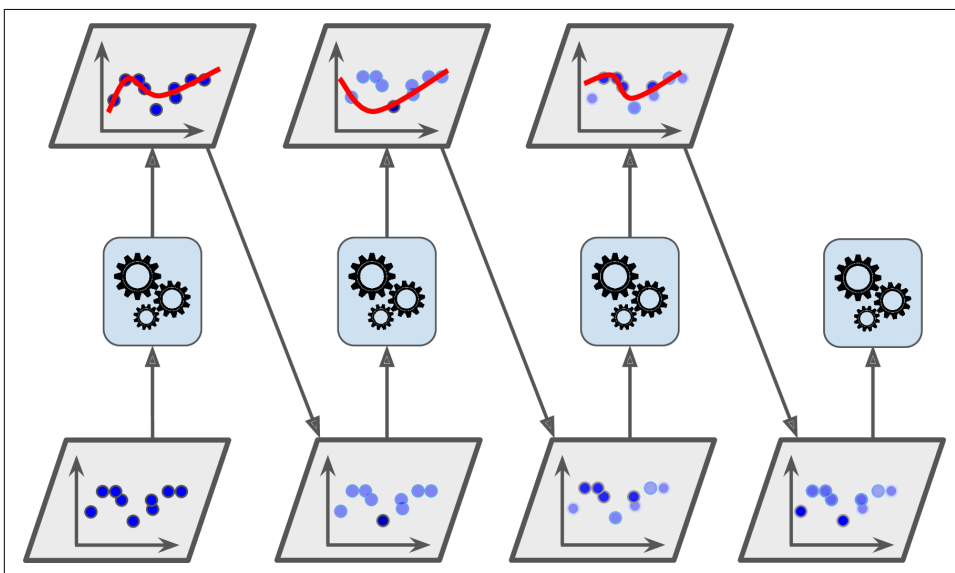

Figure 7-7. AdaBoost sequential training with instance weight updates

[Figure 7-8](#) shows the decision boundaries of five consecutive predictors on the moons dataset (in this example, each predictor is a highly regularized SVM classifier with an RBF kernel¹⁴). The first classifier gets many instances wrong, so their weights

13 “A Decision-Theoretic Generalization of On-Line Learning and an Application to Boosting,” Yoav Freund, Robert E. Schapire (1997).

14 This is just for illustrative purposes. SVMs are generally not good base predictors for AdaBoost, because they are slow and tend to be unstable with AdaBoost.

get boosted. The second classifier therefore does a better job on these instances, and so on. The plot on the right represents the same sequence of predictors except that the learning rate is halved (i.e., the misclassified instance weights are boosted half as much at every iteration). As you can see, this sequential learning technique has some similarities with Gradient Descent, except that instead of tweaking a single predictor's parameters to minimize a cost function, AdaBoost adds predictors to the ensemble, gradually making it better.

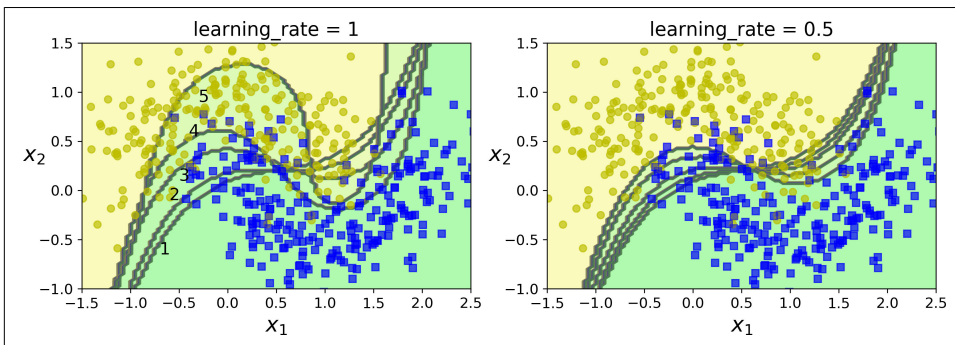

Figure 7-8. Decision boundaries of consecutive predictors

Once all predictors are trained, the ensemble makes predictions very much like bagging or pasting, except that predictors have different weights depending on their overall accuracy on the weighted training set.



There is one important drawback to this sequential learning technique: it cannot be parallelized (or only partially), since each predictor can only be trained after the previous predictor has been trained and evaluated. As a result, it does not scale as well as bagging or pasting.

Let's take a closer look at the AdaBoost algorithm. Each instance weight $w^{(i)}$ is initially set to $\frac{1}{m}$. A first predictor is trained and its weighted error rate r_1 is computed on the training set; see Equation 7-1.

Equation 7-1. Weighted error rate of the j^{th} predictor

$$r_j = \frac{\sum_{i=1}^m w^{(i)} \mathbb{1}_{\hat{y}_j^{(i)} \neq y^{(i)}}}{\sum_{i=1}^m w^{(i)}} \quad \text{where } \hat{y}_j^{(i)} \text{ is the } j^{\text{th}} \text{ predictor's prediction for the } i^{\text{th}} \text{ instance.}$$

The predictor's weight α_j is then computed using [Equation 7-2](#), where η is the learning rate hyperparameter (defaults to 1).¹⁵ The more accurate the predictor is, the higher its weight will be. If it is just guessing randomly, then its weight will be close to zero. However, if it is most often wrong (i.e., less accurate than random guessing), then its weight will be negative.

Equation 7-2. Predictor weight

$$\alpha_j = \eta \log \frac{1 - r_j}{r_j}$$

Next the instance weights are updated using [Equation 7-3](#): the misclassified instances are boosted.

Equation 7-3. Weight update rule

$$\text{for } i = 1, 2, \dots, m$$

$$w^{(i)} \leftarrow \begin{cases} w^{(i)} & \text{if } \hat{y}_j^{(i)} = y^{(i)} \\ w^{(i)} \exp(\alpha_j) & \text{if } \hat{y}_j^{(i)} \neq y^{(i)} \end{cases}$$

Then all the instance weights are normalized (i.e., divided by $\sum_{i=1}^m w^{(i)}$).

Finally, a new predictor is trained using the updated weights, and the whole process is repeated (the new predictor's weight is computed, the instance weights are updated, then another predictor is trained, and so on). The algorithm stops when the desired number of predictors is reached, or when a perfect predictor is found.

To make predictions, AdaBoost simply computes the predictions of all the predictors and weighs them using the predictor weights α_j . The predicted class is the one that receives the majority of weighted votes (see [Equation 7-4](#)).

Equation 7-4. AdaBoost predictions

$$\hat{y}(\mathbf{x}) = \underset{k}{\operatorname{argmax}} \sum_{\substack{j=1 \\ \hat{y}_j(\mathbf{x}) = k}}^N \alpha_j \quad \text{where } N \text{ is the number of predictors.}$$

¹⁵ The original AdaBoost algorithm does not use a learning rate hyperparameter.

Scikit-Learn actually uses a multiclass version of AdaBoost called *SAMME*¹⁶ (which stands for *Stagewise Additive Modeling using a Multiclass Exponential loss function*). When there are just two classes, SAMME is equivalent to AdaBoost. Moreover, if the predictors can estimate class probabilities (i.e., if they have a `predict_proba()` method), Scikit-Learn can use a variant of SAMME called *SAMME.R* (the *R* stands for “Real”), which relies on class probabilities rather than predictions and generally performs better.

The following code trains an AdaBoost classifier based on 200 *Decision Stumps* using Scikit-Learn’s `AdaBoostClassifier` class (as you might expect, there is also an `AdaBoostRegressor` class). A Decision Stump is a Decision Tree with `max_depth=1`—in other words, a tree composed of a single decision node plus two leaf nodes. This is the default base estimator for the `AdaBoostClassifier` class:

```
from sklearn.ensemble import AdaBoostClassifier

ada_clf = AdaBoostClassifier(
    DecisionTreeClassifier(max_depth=1), n_estimators=200,
    algorithm="SAMME.R", learning_rate=0.5)
ada_clf.fit(X_train, y_train)
```



If your AdaBoost ensemble is overfitting the training set, you can try reducing the number of estimators or more strongly regularizing the base estimator.

Gradient Boosting

Another very popular Boosting algorithm is *Gradient Boosting*.¹⁷ Just like AdaBoost, Gradient Boosting works by sequentially adding predictors to an ensemble, each one correcting its predecessor. However, instead of tweaking the instance weights at every iteration like AdaBoost does, this method tries to fit the new predictor to the *residual errors* made by the previous predictor.

Let’s go through a simple regression example using Decision Trees as the base predictors (of course Gradient Boosting also works great with regression tasks). This is called *Gradient Tree Boosting*, or *Gradient Boosted Regression Trees (GBRT)*. First, let’s fit a `DecisionTreeRegressor` to the training set (for example, a noisy quadratic training set):

16 For more details, see “Multi-Class AdaBoost,” J. Zhu et al. (2006).

17 First introduced in “Arcing the Edge,” L. Breiman (1997), and further developed in the paper “Greedy Function Approximation: A Gradient Boosting Machine,” Jerome H. Friedman (1999).

```

from sklearn.tree import DecisionTreeRegressor

tree_reg1 = DecisionTreeRegressor(max_depth=2)
tree_reg1.fit(X, y)

```

Now train a second `DecisionTreeRegressor` on the residual errors made by the first predictor:

```

y2 = y - tree_reg1.predict(X)
tree_reg2 = DecisionTreeRegressor(max_depth=2)
tree_reg2.fit(X, y2)

```

Then we train a third regressor on the residual errors made by the second predictor:

```

y3 = y2 - tree_reg2.predict(X)
tree_reg3 = DecisionTreeRegressor(max_depth=2)
tree_reg3.fit(X, y3)

```

Now we have an ensemble containing three trees. It can make predictions on a new instance simply by adding up the predictions of all the trees:

```

y_pred = sum(tree.predict(X_new) for tree in (tree_reg1, tree_reg2, tree_reg3))

```

Figure 7-9 represents the predictions of these three trees in the left column, and the ensemble's predictions in the right column. In the first row, the ensemble has just one tree, so its predictions are exactly the same as the first tree's predictions. In the second row, a new tree is trained on the residual errors of the first tree. On the right you can see that the ensemble's predictions are equal to the sum of the predictions of the first two trees. Similarly, in the third row another tree is trained on the residual errors of the second tree. You can see that the ensemble's predictions gradually get better as trees are added to the ensemble.

A simpler way to train GBRT ensembles is to use Scikit-Learn's `GradientBoostingRegressor` class. Much like the `RandomForestRegressor` class, it has hyperparameters to control the growth of Decision Trees (e.g., `max_depth`, `min_samples_leaf`, and so on), as well as hyperparameters to control the ensemble training, such as the number of trees (`n_estimators`). The following code creates the same ensemble as the previous one:

```

from sklearn.ensemble import GradientBoostingRegressor

gbrt = GradientBoostingRegressor(max_depth=2, n_estimators=3, learning_rate=1.0)
gbrt.fit(X, y)

```

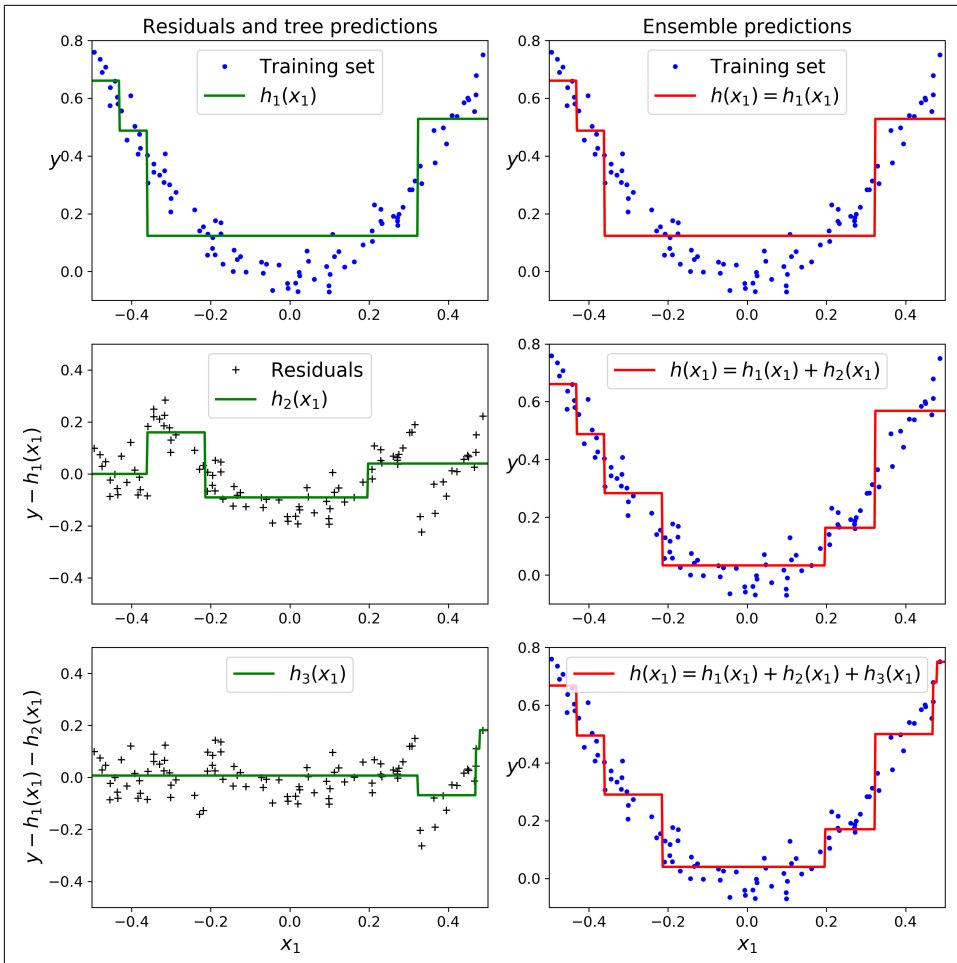



Figure 7-9. Gradient Boosting

The `learning_rate` hyperparameter scales the contribution of each tree. If you set it to a low value, such as `0.1`, you will need more trees in the ensemble to fit the training set, but the predictions will usually generalize better. This is a regularization technique called *shrinkage*. Figure 7-10 shows two GBRT ensembles trained with a low learning rate: the one on the left does not have enough trees to fit the training set, while the one on the right has too many trees and overfits the training set.

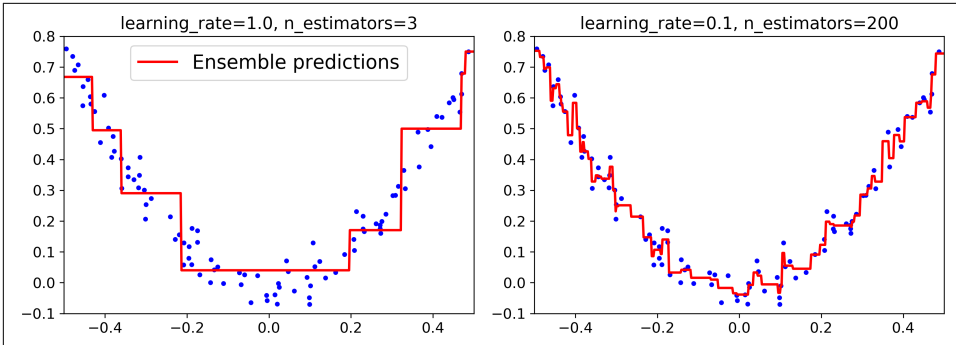

Figure 7-10. GBRT ensembles with not enough predictors (left) and too many (right)

In order to find the optimal number of trees, you can use early stopping (see [Chapter 4](#)). A simple way to implement this is to use the `staged_predict()` method: it returns an iterator over the predictions made by the ensemble at each stage of training (with one tree, two trees, etc.). The following code trains a GBRT ensemble with 120 trees, then measures the validation error at each stage of training to find the optimal number of trees, and finally trains another GBRT ensemble using the optimal number of trees:

```
import numpy as np
from sklearn.model_selection import train_test_split
from sklearn.metrics import mean_squared_error

X_train, X_val, y_train, y_val = train_test_split(X, y)

gbrt = GradientBoostingRegressor(max_depth=2, n_estimators=120)
gbrt.fit(X_train, y_train)

errors = [mean_squared_error(y_val, y_pred)
          for y_pred in gbrt.staged_predict(X_val)]
bst_n_estimators = np.argmin(errors)

gbrt_best = GradientBoostingRegressor(max_depth=2, n_estimators=bst_n_estimators)
gbrt_best.fit(X_train, y_train)
```

The validation errors are represented on the left of [Figure 7-11](#), and the best model's predictions are represented on the right.

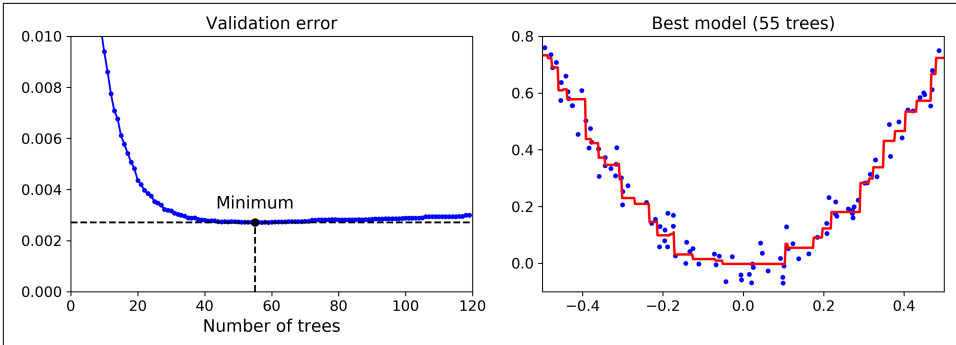

Figure 7-11. Tuning the number of trees using early stopping

It is also possible to implement early stopping by actually stopping training early (instead of training a large number of trees first and then looking back to find the optimal number). You can do so by setting `warm_start=True`, which makes Scikit-Learn keep existing trees when the `fit()` method is called, allowing incremental training. The following code stops training when the validation error does not improve for five iterations in a row:

```
gbrt = GradientBoostingRegressor(max_depth=2, warm_start=True)

min_val_error = float("inf")
error_going_up = 0
for n_estimators in range(1, 120):
    gbrt.n_estimators = n_estimators
    gbrt.fit(X_train, y_train)
    y_pred = gbrt.predict(X_val)
    val_error = mean_squared_error(y_val, y_pred)
    if val_error < min_val_error:
        min_val_error = val_error
        error_going_up = 0
    else:
        error_going_up += 1
        if error_going_up == 5:
            break # early stopping
```

The `GradientBoostingRegressor` class also supports a `subsample` hyperparameter, which specifies the fraction of training instances to be used for training each tree. For example, if `subsample=0.25`, then each tree is trained on 25% of the training instances, selected randomly. As you can probably guess by now, this trades a higher bias for a lower variance. It also speeds up training considerably. This technique is called *Stochastic Gradient Boosting*.



It is possible to use Gradient Boosting with other cost functions. This is controlled by the `loss` hyperparameter (see Scikit-Learn's documentation for more details).

It is worth noting that an optimized implementation of Gradient Boosting is available in the popular python library *XGBoost*, which stands for Extreme Gradient Boosting. This package was initially developed by Tianqi Chen as part of the Distributed (Deep) Machine Learning Community (*DMLC*), and it aims at being extremely fast, scalable and portable. In fact, XGBoost is often an important component of the winning entries in ML competitions. XGBoost's API is quite similar to Scikit-Learn's:

```
import xgboost

xgb_reg = xgboost.XGBRegressor()
xgb_reg.fit(X_train, y_train)
y_pred = xgb_reg.predict(X_val)
```

XGBoost also offers several nice features, such as automatically taking care of early stopping:

```
xgb_reg.fit(X_train, y_train,
            eval_set=[(X_val, y_val)], early_stopping_rounds=2)
y_pred = xgb_reg.predict(X_val)
```

You should definitely check it out!

Stacking

The last Ensemble method we will discuss in this chapter is called *stacking* (short for *stacked generalization*).¹⁸ It is based on a simple idea: instead of using trivial functions (such as hard voting) to aggregate the predictions of all predictors in an ensemble, why don't we train a model to perform this aggregation? **Figure 7-12** shows such an ensemble performing a regression task on a new instance. Each of the bottom three predictors predicts a different value (3.1, 2.7, and 2.9), and then the final predictor (called a *blender*, or a *meta learner*) takes these predictions as inputs and makes the final prediction (3.0).

¹⁸ "Stacked Generalization," D. Wolpert (1992).

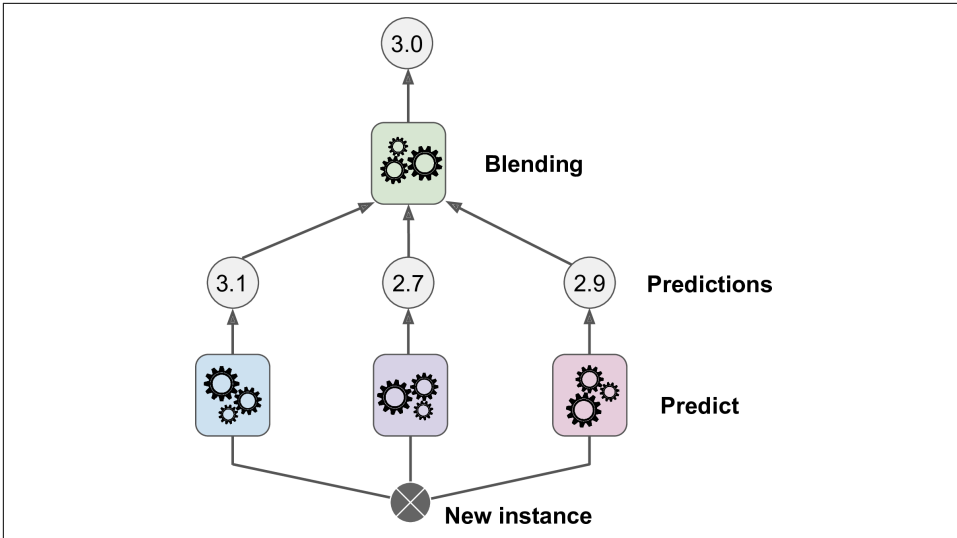

Figure 7-12. Aggregating predictions using a blending predictor

To train the blender, a common approach is to use a hold-out set.¹⁹ Let's see how it works. First, the training set is split in two subsets. The first subset is used to train the predictors in the first layer (see Figure 7-13).

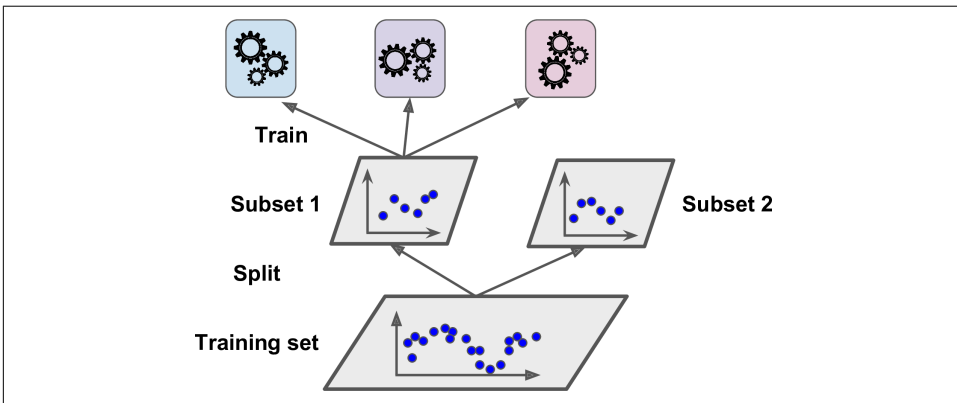

Figure 7-13. Training the first layer

Next, the first layer predictors are used to make predictions on the second (held-out) set (see Figure 7-14). This ensures that the predictions are “clean,” since the predictors never saw these instances during training. Now for each instance in the hold-out set

¹⁹ Alternatively, it is possible to use out-of-fold predictions. In some contexts this is called *stacking*, while using a hold-out set is called *blending*. However, for many people these terms are synonymous.

there are three predicted values. We can create a new training set using these predicted values as input features (which makes this new training set three-dimensional), and keeping the target values. The blender is trained on this new training set, so it learns to predict the target value given the first layer's predictions.

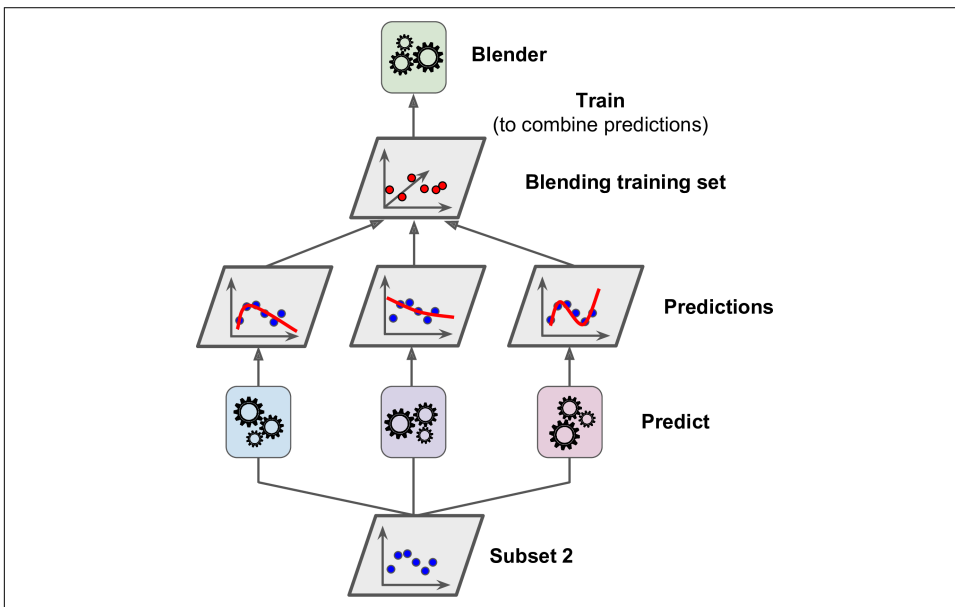

Figure 7-14. Training the blender

It is actually possible to train several different blenders this way (e.g., one using Linear Regression, another using Random Forest Regression, and so on): we get a whole layer of blenders. The trick is to split the training set into three subsets: the first one is used to train the first layer, the second one is used to create the training set used to train the second layer (using predictions made by the predictors of the first layer), and the third one is used to create the training set to train the third layer (using predictions made by the predictors of the second layer). Once this is done, we can make a prediction for a new instance by going through each layer sequentially, as shown in [Figure 7-15](#).

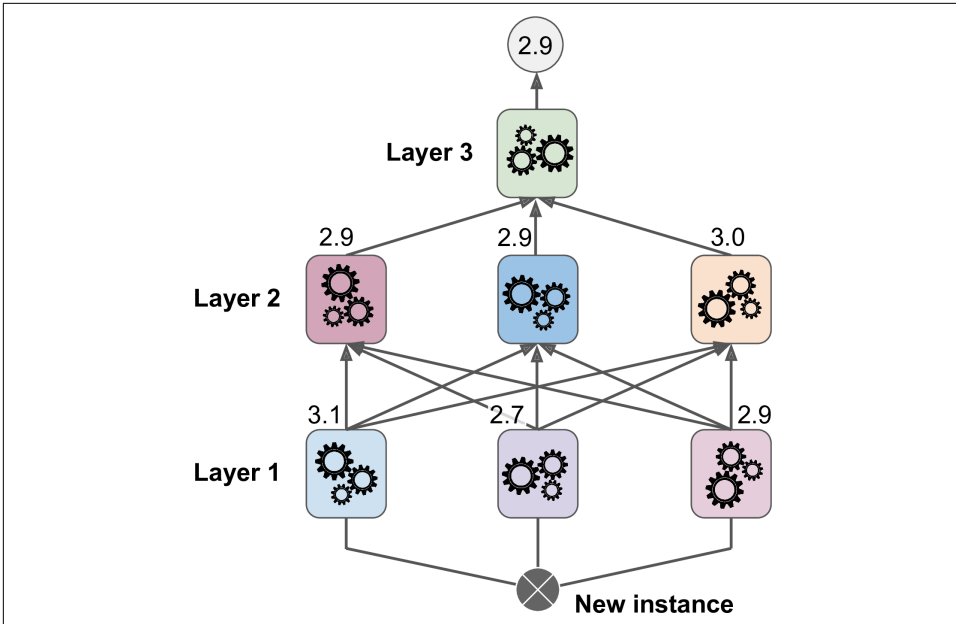

Figure 7-15. Predictions in a multilayer stacking ensemble

Unfortunately, Scikit-Learn does not support stacking directly, but it is not too hard to roll out your own implementation (see the following exercises). Alternatively, you can use an open source implementation such as *brew* (available at <https://github.com/viisar/brew>).

Exercises

1. If you have trained five different models on the exact same training data, and they all achieve 95% precision, is there any chance that you can combine these models to get better results? If so, how? If not, why?
2. What is the difference between hard and soft voting classifiers?
3. Is it possible to speed up training of a bagging ensemble by distributing it across multiple servers? What about pasting ensembles, boosting ensembles, random forests, or stacking ensembles?
4. What is the benefit of out-of-bag evaluation?
5. What makes Extra-Trees more random than regular Random Forests? How can this extra randomness help? Are Extra-Trees slower or faster than regular Random Forests?
6. If your AdaBoost ensemble underfits the training data, what hyperparameters should you tweak and how?

7. If your Gradient Boosting ensemble overfits the training set, should you increase or decrease the learning rate?
8. Load the MNIST data (introduced in [Chapter 3](#)), and split it into a training set, a validation set, and a test set (e.g., use 50,000 instances for training, 10,000 for validation, and 10,000 for testing). Then train various classifiers, such as a Random Forest classifier, an Extra-Trees classifier, and an SVM. Next, try to combine them into an ensemble that outperforms them all on the validation set, using a soft or hard voting classifier. Once you have found one, try it on the test set. How much better does it perform compared to the individual classifiers?
9. Run the individual classifiers from the previous exercise to make predictions on the validation set, and create a new training set with the resulting predictions: each training instance is a vector containing the set of predictions from all your classifiers for an image, and the target is the image's class. Train a classifier on this new training set. Congratulations, you have just trained a blender, and together with the classifiers they form a stacking ensemble! Now let's evaluate the ensemble on the test set. For each image in the test set, make predictions with all your classifiers, then feed the predictions to the blender to get the ensemble's predictions. How does it compare to the voting classifier you trained earlier?

Solutions to these exercises are available in [???](#).

Dimensionality Reduction



With Early Release ebooks, you get books in their earliest form—the author’s raw and unedited content as he or she writes—so you can take advantage of these technologies long before the official release of these titles. The following will be Chapter 8 in the final release of the book.

Many Machine Learning problems involve thousands or even millions of features for each training instance. Not only does this make training extremely slow, it can also make it much harder to find a good solution, as we will see. This problem is often referred to as the *curse of dimensionality*.

Fortunately, in real-world problems, it is often possible to reduce the number of features considerably, turning an intractable problem into a tractable one. For example, consider the MNIST images (introduced in [Chapter 3](#)): the pixels on the image borders are almost always white, so you could completely drop these pixels from the training set without losing much information. [Figure 7-6](#) confirms that these pixels are utterly unimportant for the classification task. Moreover, two neighboring pixels are often highly correlated: if you merge them into a single pixel (e.g., by taking the mean of the two pixel intensities), you will not lose much information.



Reducing dimensionality does lose some information (just like compressing an image to JPEG can degrade its quality), so even though it will speed up training, it may also make your system perform slightly worse. It also makes your pipelines a bit more complex and thus harder to maintain. So you should first try to train your system with the original data before considering using dimensionality reduction if training is too slow. In some cases, however, reducing the dimensionality of the training data may filter out some noise and unnecessary details and thus result in higher performance (but in general it won't; it will just speed up training).

Apart from speeding up training, dimensionality reduction is also extremely useful for data visualization (or *DataViz*). Reducing the number of dimensions down to two (or three) makes it possible to plot a condensed view of a high-dimensional training set on a graph and often gain some important insights by visually detecting patterns, such as clusters. Moreover, *DataViz* is essential to communicate your conclusions to people who are not data scientists, in particular decision makers who will use your results.

In this chapter we will discuss the curse of dimensionality and get a sense of what goes on in high-dimensional space. Then, we will present the two main approaches to dimensionality reduction (projection and Manifold Learning), and we will go through three of the most popular dimensionality reduction techniques: PCA, Kernel PCA, and LLE.

The Curse of Dimensionality

We are so used to living in three dimensions¹ that our intuition fails us when we try to imagine a high-dimensional space. Even a basic 4D hypercube is incredibly hard to picture in our mind (see [Figure 8-1](#)), let alone a 200-dimensional ellipsoid bent in a 1,000-dimensional space.

¹ Well, four dimensions if you count time, and a few more if you are a string theorist.

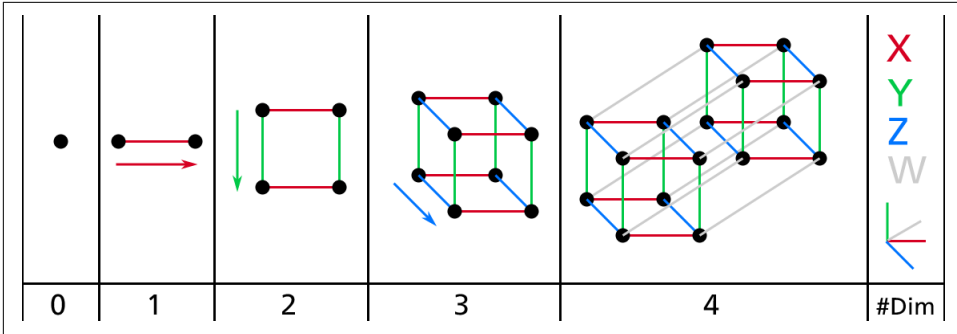

Figure 8-1. Point, segment, square, cube, and tesseract (0D to 4D hypercubes)²

It turns out that many things behave very differently in high-dimensional space. For example, if you pick a random point in a unit square (a 1×1 square), it will have only about a 0.4% chance of being located less than 0.001 from a border (in other words, it is very unlikely that a random point will be “extreme” along any dimension). But in a 10,000-dimensional unit hypercube (a $1 \times 1 \times \dots \times 1$ cube, with ten thousand 1s), this probability is greater than 99.999999%. Most points in a high-dimensional hypercube are very close to the border.³

Here is a more troublesome difference: if you pick two points randomly in a unit square, the distance between these two points will be, on average, roughly 0.52. If you pick two random points in a unit 3D cube, the average distance will be roughly 0.66. But what about two points picked randomly in a 1,000,000-dimensional hypercube? Well, the average distance, believe it or not, will be about 408.25 (roughly $\sqrt{1,000,000/6}$)! This is quite counterintuitive: how can two points be so far apart when they both lie within the same unit hypercube? This fact implies that high-dimensional datasets are at risk of being very sparse: most training instances are likely to be far away from each other. Of course, this also means that a new instance will likely be far away from any training instance, making predictions much less reliable than in lower dimensions, since they will be based on much larger extrapolations. In short, the more dimensions the training set has, the greater the risk of overfitting it.

In theory, one solution to the curse of dimensionality could be to increase the size of the training set to reach a sufficient density of training instances. Unfortunately, in practice, the number of training instances required to reach a given density grows exponentially with the number of dimensions. With just 100 features (much less than

2 Watch a rotating tesseract projected into 3D space at <https://homl.info/30>. Image by Wikipedia user Nerd-Boy1392 (Creative Commons BY-SA 3.0). Reproduced from <https://en.wikipedia.org/wiki/Tesseract>.

3 Fun fact: anyone you know is probably an extremist in at least one dimension (e.g., how much sugar they put in their coffee), if you consider enough dimensions.

in the MNIST problem), you would need more training instances than atoms in the observable universe in order for training instances to be within 0.1 of each other on average, assuming they were spread out uniformly across all dimensions.

Main Approaches for Dimensionality Reduction

Before we dive into specific dimensionality reduction algorithms, let's take a look at the two main approaches to reducing dimensionality: projection and Manifold Learning.

Projection

In most real-world problems, training instances are *not* spread out uniformly across all dimensions. Many features are almost constant, while others are highly correlated (as discussed earlier for MNIST). As a result, all training instances actually lie within (or close to) a much lower-dimensional *subspace* of the high-dimensional space. This sounds very abstract, so let's look at an example. In [Figure 8-2](#) you can see a 3D dataset represented by the circles.

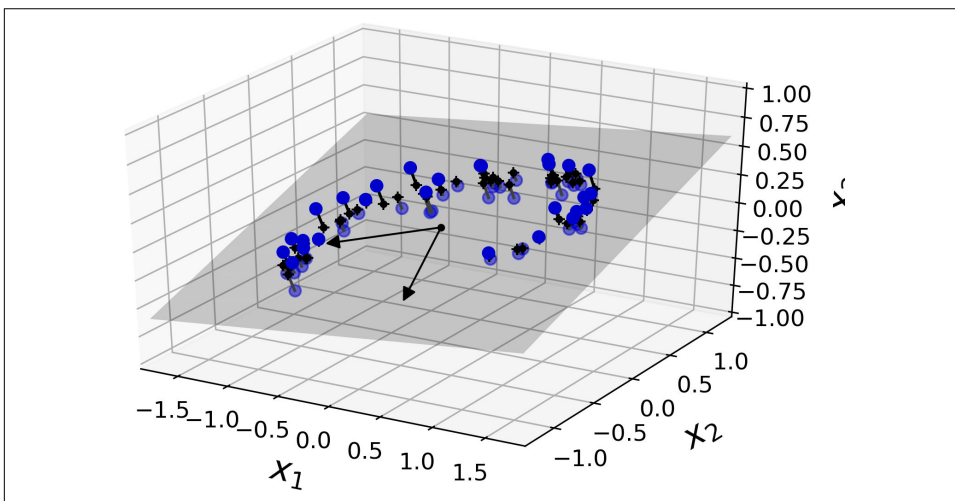

Figure 8-2. A 3D dataset lying close to a 2D subspace

Notice that all training instances lie close to a plane: this is a lower-dimensional (2D) subspace of the high-dimensional (3D) space. Now if we project every training instance perpendicularly onto this subspace (as represented by the short lines connecting the instances to the plane), we get the new 2D dataset shown in [Figure 8-3](#). Ta-da! We have just reduced the dataset's dimensionality from 3D to 2D. Note that the axes correspond to new features z_1 and z_2 (the coordinates of the projections on the plane).

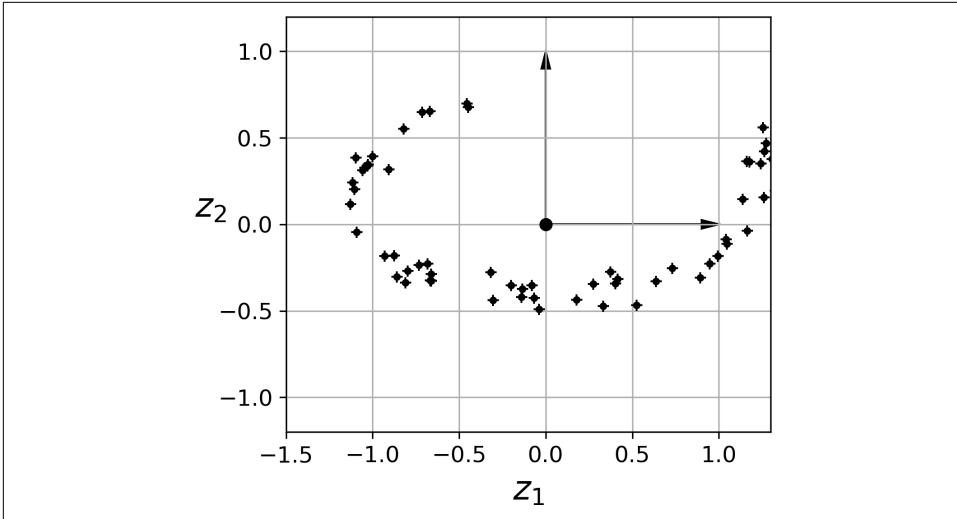

Figure 8-3. The new 2D dataset after projection

However, projection is not always the best approach to dimensionality reduction. In many cases the subspace may twist and turn, such as in the famous *Swiss roll* toy dataset represented in Figure 8-4.

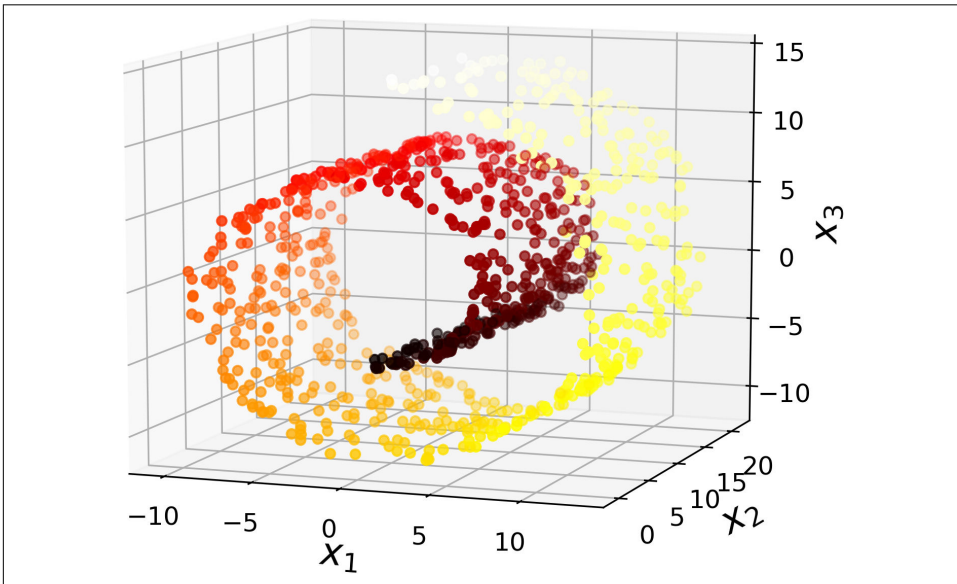

Figure 8-4. Swiss roll dataset

Simply projecting onto a plane (e.g., by dropping x_3) would squash different layers of the Swiss roll together, as shown on the left of [Figure 8-5](#). However, what you really want is to unroll the Swiss roll to obtain the 2D dataset on the right of [Figure 8-5](#).

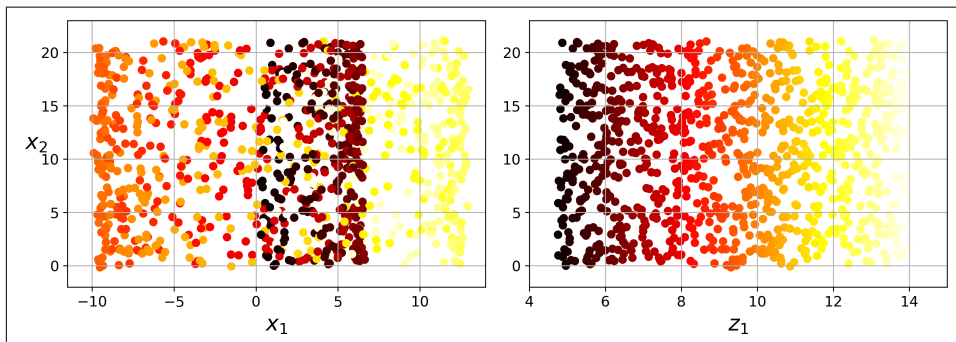

Figure 8-5. Squashing by projecting onto a plane (left) versus unrolling the Swiss roll (right)

Manifold Learning

The Swiss roll is an example of a 2D *manifold*. Put simply, a 2D manifold is a 2D shape that can be bent and twisted in a higher-dimensional space. More generally, a d -dimensional manifold is a part of an n -dimensional space (where $d < n$) that locally resembles a d -dimensional hyperplane. In the case of the Swiss roll, $d = 2$ and $n = 3$: it locally resembles a 2D plane, but it is rolled in the third dimension.

Many dimensionality reduction algorithms work by modeling the *manifold* on which the training instances lie; this is called *Manifold Learning*. It relies on the *manifold assumption*, also called the *manifold hypothesis*, which holds that most real-world high-dimensional datasets lie close to a much lower-dimensional manifold. This assumption is very often empirically observed.

Once again, think about the MNIST dataset: all handwritten digit images have some similarities. They are made of connected lines, the borders are white, they are more or less centered, and so on. If you randomly generated images, only a ridiculously tiny fraction of them would look like handwritten digits. In other words, the degrees of freedom available to you if you try to create a digit image are dramatically lower than the degrees of freedom you would have if you were allowed to generate any image you wanted. These constraints tend to squeeze the dataset into a lower-dimensional manifold.

The manifold assumption is often accompanied by another implicit assumption: that the task at hand (e.g., classification or regression) will be simpler if expressed in the lower-dimensional space of the manifold. For example, in the top row of [Figure 8-6](#) the Swiss roll is split into two classes: in the 3D space (on the left), the decision

boundary would be fairly complex, but in the 2D unrolled manifold space (on the right), the decision boundary is a simple straight line.

However, this assumption does not always hold. For example, in the bottom row of **Figure 8-6**, the decision boundary is located at $x_1 = 5$. This decision boundary looks very simple in the original 3D space (a vertical plane), but it looks more complex in the unrolled manifold (a collection of four independent line segments).

In short, if you reduce the dimensionality of your training set before training a model, it will usually speed up training, but it may not always lead to a better or simpler solution; it all depends on the dataset.

Hopefully you now have a good sense of what the curse of dimensionality is and how dimensionality reduction algorithms can fight it, especially when the manifold assumption holds. The rest of this chapter will go through some of the most popular algorithms.

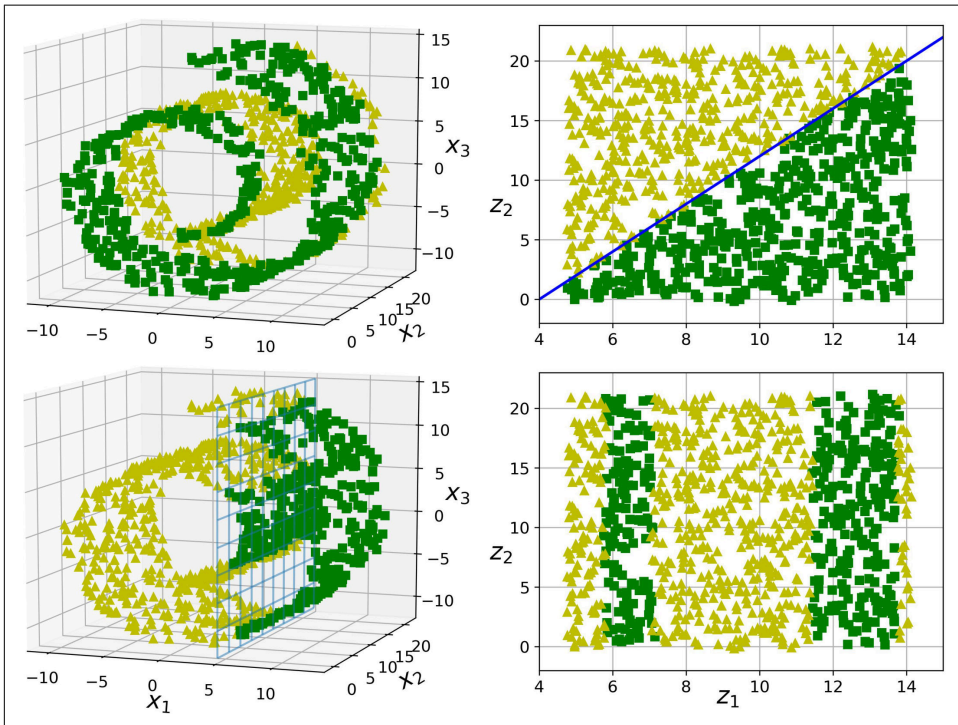

Figure 8-6. The decision boundary may not always be simpler with lower dimensions

PCA

Principal Component Analysis (PCA) is by far the most popular dimensionality reduction algorithm. First it identifies the hyperplane that lies closest to the data, and then it projects the data onto it, just like in [Figure 8-2](#).

Preserving the Variance

Before you can project the training set onto a lower-dimensional hyperplane, you first need to choose the right hyperplane. For example, a simple 2D dataset is represented on the left of [Figure 8-7](#), along with three different axes (i.e., one-dimensional hyperplanes). On the right is the result of the projection of the dataset onto each of these axes. As you can see, the projection onto the solid line preserves the maximum variance, while the projection onto the dotted line preserves very little variance, and the projection onto the dashed line preserves an intermediate amount of variance.

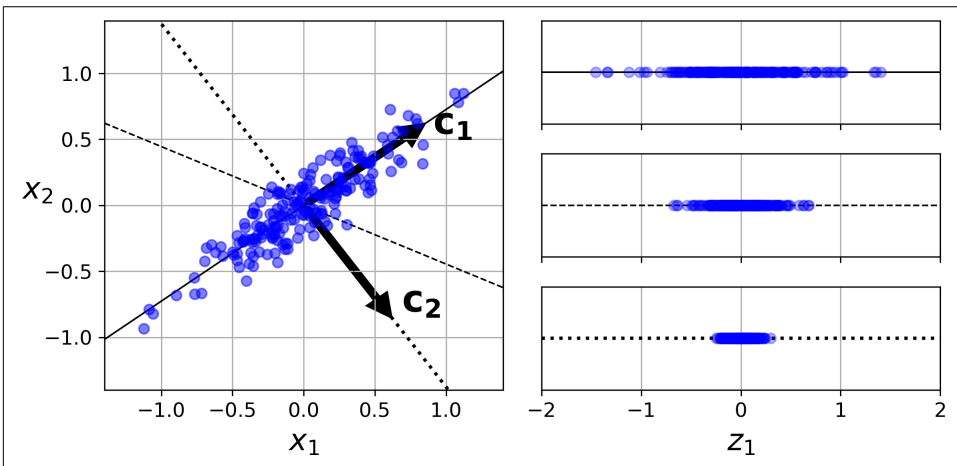

Figure 8-7. Selecting the subspace onto which to project

It seems reasonable to select the axis that preserves the maximum amount of variance, as it will most likely lose less information than the other projections. Another way to justify this choice is that it is the axis that minimizes the mean squared distance between the original dataset and its projection onto that axis. This is the rather simple idea behind [PCA](#).⁴

⁴ “On Lines and Planes of Closest Fit to Systems of Points in Space,” K. Pearson (1901).

Principal Components

PCA identifies the axis that accounts for the largest amount of variance in the training set. In [Figure 8-7](#), it is the solid line. It also finds a second axis, orthogonal to the first one, that accounts for the largest amount of remaining variance. In this 2D example there is no choice: it is the dotted line. If it were a higher-dimensional dataset, PCA would also find a third axis, orthogonal to both previous axes, and a fourth, a fifth, and so on—as many axes as the number of dimensions in the dataset.

The unit vector that defines the i^{th} axis is called the i^{th} *principal component* (PC). In [Figure 8-7](#), the 1st PC is \mathbf{c}_1 and the 2nd PC is \mathbf{c}_2 . In [Figure 8-2](#) the first two PCs are represented by the orthogonal arrows in the plane, and the third PC would be orthogonal to the plane (pointing up or down).



The direction of the principal components is not stable: if you perturb the training set slightly and run PCA again, some of the new PCs may point in the opposite direction of the original PCs. However, they will generally still lie on the same axes. In some cases, a pair of PCs may even rotate or swap, but the plane they define will generally remain the same.

So how can you find the principal components of a training set? Luckily, there is a standard matrix factorization technique called *Singular Value Decomposition* (SVD) that can decompose the training set matrix \mathbf{X} into the matrix multiplication of three matrices $\mathbf{U} \Sigma \mathbf{V}^T$, where \mathbf{V} contains all the principal components that we are looking for, as shown in [Equation 8-1](#).

Equation 8-1. Principal components matrix

$$\mathbf{V} = \begin{pmatrix} | & | & \cdots & | \\ \mathbf{c}_1 & \mathbf{c}_2 & \cdots & \mathbf{c}_n \\ | & | & & | \end{pmatrix}$$

The following Python code uses NumPy's `svd()` function to obtain all the principal components of the training set, then extracts the first two PCs:

```
X_centered = X - X.mean(axis=0)
U, s, Vt = np.linalg.svd(X_centered)
c1 = Vt.T[:, 0]
c2 = Vt.T[:, 1]
```



PCA assumes that the dataset is centered around the origin. As we will see, Scikit-Learn's PCA classes take care of centering the data for you. However, if you implement PCA yourself (as in the preceding example), or if you use other libraries, don't forget to center the data first.

Projecting Down to d Dimensions

Once you have identified all the principal components, you can reduce the dimensionality of the dataset down to d dimensions by projecting it onto the hyperplane defined by the first d principal components. Selecting this hyperplane ensures that the projection will preserve as much variance as possible. For example, in [Figure 8-2](#) the 3D dataset is projected down to the 2D plane defined by the first two principal components, preserving a large part of the dataset's variance. As a result, the 2D projection looks very much like the original 3D dataset.

To project the training set onto the hyperplane, you can simply compute the matrix multiplication of the training set matrix \mathbf{X} by the matrix \mathbf{W}_d , defined as the matrix containing the first d principal components (i.e., the matrix composed of the first d columns of \mathbf{V}), as shown in [Equation 8-2](#).

Equation 8-2. Projecting the training set down to d dimensions

$$\mathbf{X}_{d\text{-proj}} = \mathbf{X}\mathbf{W}_d$$

The following Python code projects the training set onto the plane defined by the first two principal components:

```
w2 = Vt.T[:, :2]
X2D = X_centered.dot(w2)
```

There you have it! You now know how to reduce the dimensionality of any dataset down to any number of dimensions, while preserving as much variance as possible.

Using Scikit-Learn

Scikit-Learn's PCA class implements PCA using SVD decomposition just like we did before. The following code applies PCA to reduce the dimensionality of the dataset down to two dimensions (note that it automatically takes care of centering the data):

```
from sklearn.decomposition import PCA

pca = PCA(n_components = 2)
X2D = pca.fit_transform(X)
```

After fitting the PCA transformer to the dataset, you can access the principal components using the `components_` variable (note that it contains the PCs as horizontal vec-

tors, so, for example, the first principal component is equal to `pca.components_.T[:, 0]`).

Explained Variance Ratio

Another very useful piece of information is the *explained variance ratio* of each principal component, available via the `explained_variance_ratio_` variable. It indicates the proportion of the dataset's variance that lies along the axis of each principal component. For example, let's look at the explained variance ratios of the first two components of the 3D dataset represented in [Figure 8-2](#):

```
>>> pca.explained_variance_ratio_  
array([0.84248607, 0.14631839])
```

This tells you that 84.2% of the dataset's variance lies along the first axis, and 14.6% lies along the second axis. This leaves less than 1.2% for the third axis, so it is reasonable to assume that it probably carries little information.

Choosing the Right Number of Dimensions

Instead of arbitrarily choosing the number of dimensions to reduce down to, it is generally preferable to choose the number of dimensions that add up to a sufficiently large portion of the variance (e.g., 95%). Unless, of course, you are reducing dimensionality for data visualization—in that case you will generally want to reduce the dimensionality down to 2 or 3.

The following code computes PCA without reducing dimensionality, then computes the minimum number of dimensions required to preserve 95% of the training set's variance:

```
pca = PCA()  
pca.fit(X_train)  
cumsum = np.cumsum(pca.explained_variance_ratio_)  
d = np.argmax(cumsum >= 0.95) + 1
```

You could then set `n_components=d` and run PCA again. However, there is a much better option: instead of specifying the number of principal components you want to preserve, you can set `n_components` to be a float between 0.0 and 1.0, indicating the ratio of variance you wish to preserve:

```
pca = PCA(n_components=0.95)  
X_reduced = pca.fit_transform(X_train)
```

Yet another option is to plot the explained variance as a function of the number of dimensions (simply plot `cumsum`; see [Figure 8-8](#)). There will usually be an elbow in the curve, where the explained variance stops growing fast. You can think of this as the intrinsic dimensionality of the dataset. In this case, you can see that reducing the

dimensionality down to about 100 dimensions wouldn't lose too much explained variance.

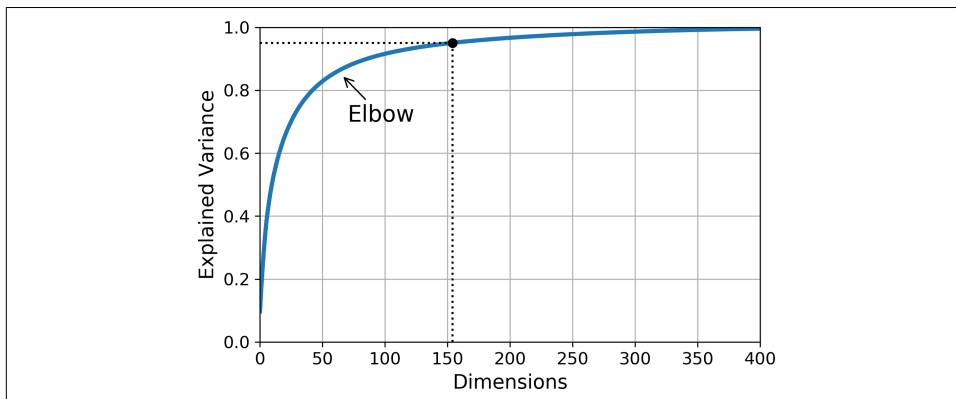

Figure 8-8. Explained variance as a function of the number of dimensions

PCA for Compression

Obviously after dimensionality reduction, the training set takes up much less space. For example, try applying PCA to the MNIST dataset while preserving 95% of its variance. You should find that each instance will have just over 150 features, instead of the original 784 features. So while most of the variance is preserved, the dataset is now less than 20% of its original size! This is a reasonable compression ratio, and you can see how this can speed up a classification algorithm (such as an SVM classifier) tremendously.

It is also possible to decompress the reduced dataset back to 784 dimensions by applying the inverse transformation of the PCA projection. Of course this won't give you back the original data, since the projection lost a bit of information (within the 5% variance that was dropped), but it will likely be quite close to the original data. The mean squared distance between the original data and the reconstructed data (compressed and then decompressed) is called the *reconstruction error*. For example, the following code compresses the MNIST dataset down to 154 dimensions, then uses the `inverse_transform()` method to decompress it back to 784 dimensions. [Figure 8-9](#) shows a few digits from the original training set (on the left), and the corresponding digits after compression and decompression. You can see that there is a slight image quality loss, but the digits are still mostly intact.

```
pca = PCA(n_components = 154)
X_reduced = pca.fit_transform(X_train)
X_recovered = pca.inverse_transform(X_reduced)
```

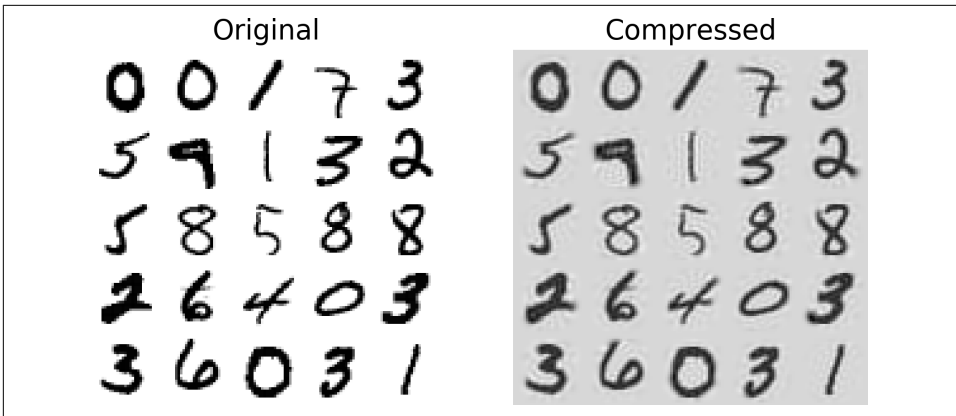

Figure 8-9. MNIST compression preserving 95% of the variance

The equation of the inverse transformation is shown in [Equation 8-3](#).

Equation 8-3. PCA inverse transformation, back to the original number of dimensions

$$\mathbf{X}_{\text{recovered}} = \mathbf{X}_{d\text{-proj}} \mathbf{W}_d^T$$

Randomized PCA

If you set the `svd_solver` hyperparameter to "randomized", Scikit-Learn uses a stochastic algorithm called *Randomized PCA* that quickly finds an approximation of the first d principal components. Its computational complexity is $O(m \times d^2) + O(d^3)$, instead of $O(m \times n^2) + O(n^3)$ for the full SVD approach, so it is dramatically faster than full SVD when d is much smaller than n :

```
rnd_pca = PCA(n_components=154, svd_solver="randomized")
X_reduced = rnd_pca.fit_transform(X_train)
```

By default, `svd_solver` is actually set to "auto": Scikit-Learn automatically uses the randomized PCA algorithm if m or n is greater than 500 and d is less than 80% of m or n , or else it uses the full SVD approach. If you want to force Scikit-Learn to use full SVD, you can set the `svd_solver` hyperparameter to "full".

Incremental PCA

One problem with the preceding implementations of PCA is that they require the whole training set to fit in memory in order for the algorithm to run. Fortunately, *Incremental PCA* (IPCA) algorithms have been developed: you can split the training set into mini-batches and feed an IPCA algorithm one mini-batch at a time. This is

useful for large training sets, and also to apply PCA online (i.e., on the fly, as new instances arrive).

The following code splits the MNIST dataset into 100 mini-batches (using NumPy's `array_split()` function) and feeds them to Scikit-Learn's `IncrementalPCA` class⁵ to reduce the dimensionality of the MNIST dataset down to 154 dimensions (just like before). Note that you must call the `partial_fit()` method with each mini-batch rather than the `fit()` method with the whole training set:

```
from sklearn.decomposition import IncrementalPCA

n_batches = 100
inc_pca = IncrementalPCA(n_components=154)
for X_batch in np.array_split(X_train, n_batches):
    inc_pca.partial_fit(X_batch)

X_reduced = inc_pca.transform(X_train)
```

Alternatively, you can use NumPy's `mmap` class, which allows you to manipulate a large array stored in a binary file on disk as if it were entirely in memory; the class loads only the data it needs in memory, when it needs it. Since the `IncrementalPCA` class uses only a small part of the array at any given time, the memory usage remains under control. This makes it possible to call the usual `fit()` method, as you can see in the following code:

```
X_mm = np.mmap(filename, dtype="float32", mode="readonly", shape=(m, n))

batch_size = m // n_batches
inc_pca = IncrementalPCA(n_components=154, batch_size=batch_size)
inc_pca.fit(X_mm)
```

Kernel PCA

In [Chapter 5](#) we discussed the kernel trick, a mathematical technique that implicitly maps instances into a very high-dimensional space (called the *feature space*), enabling nonlinear classification and regression with Support Vector Machines. Recall that a linear decision boundary in the high-dimensional feature space corresponds to a complex nonlinear decision boundary in the *original space*.

It turns out that the same trick can be applied to PCA, making it possible to perform complex nonlinear projections for dimensionality reduction. This is called *Kernel*

⁵ Scikit-Learn uses the algorithm described in “Incremental Learning for Robust Visual Tracking,” D. Ross et al. (2007).

PCA (kPCA).⁶ It is often good at preserving clusters of instances after projection, or sometimes even unrolling datasets that lie close to a twisted manifold.

For example, the following code uses Scikit-Learn's `KernelPCA` class to perform kPCA with an RBF kernel (see [Chapter 5](#) for more details about the RBF kernel and the other kernels):

```
from sklearn.decomposition import KernelPCA

rbf_pca = KernelPCA(n_components = 2, kernel="rbf", gamma=0.04)
X_reduced = rbf_pca.fit_transform(X)
```

[Figure 8-10](#) shows the Swiss roll, reduced to two dimensions using a linear kernel (equivalent to simply using the `PCA` class), an RBF kernel, and a sigmoid kernel (Logistic).

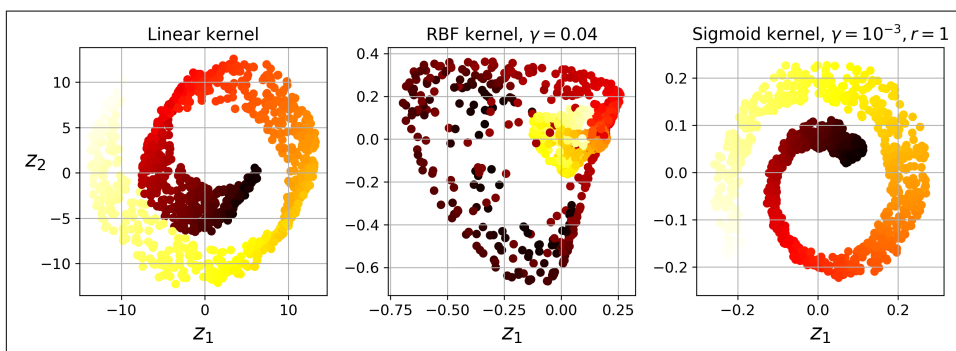

Figure 8-10. Swiss roll reduced to 2D using kPCA with various kernels

Selecting a Kernel and Tuning Hyperparameters

As kPCA is an unsupervised learning algorithm, there is no obvious performance measure to help you select the best kernel and hyperparameter values. However, dimensionality reduction is often a preparation step for a supervised learning task (e.g., classification), so you can simply use grid search to select the kernel and hyperparameters that lead to the best performance on that task. For example, the following code creates a two-step pipeline, first reducing dimensionality to two dimensions using kPCA, then applying Logistic Regression for classification. Then it uses `Grid SearchCV` to find the best kernel and gamma value for kPCA in order to get the best classification accuracy at the end of the pipeline:

```
from sklearn.model_selection import GridSearchCV
from sklearn.linear_model import LogisticRegression
from sklearn.pipeline import Pipeline
```

⁶ “Kernel Principal Component Analysis,” B. Schölkopf, A. Smola, K. Müller (1999).

```

clf = Pipeline([
    ("kpc", KernelPCA(n_components=2)),
    ("log_reg", LogisticRegression())
])

param_grid = [{
    "kpc__gamma": np.linspace(0.03, 0.05, 10),
    "kpc__kernel": ["rbf", "sigmoid"]
}]

grid_search = GridSearchCV(clf, param_grid, cv=3)
grid_search.fit(X, y)

```

The best kernel and hyperparameters are then available through the `best_params_` variable:

```

>>> print(grid_search.best_params_)
{'kpc__gamma': 0.04333333333333335, 'kpc__kernel': 'rbf'}

```

Another approach, this time entirely unsupervised, is to select the kernel and hyperparameters that yield the lowest reconstruction error. However, reconstruction is not as easy as with linear PCA. Here's why. [Figure 8-11](#) shows the original Swiss roll 3D dataset (top left), and the resulting 2D dataset after kPCA is applied using an RBF kernel (top right). Thanks to the kernel trick, this is mathematically equivalent to mapping the training set to an infinite-dimensional feature space (bottom right) using the *feature map* ϕ , then projecting the transformed training set down to 2D using linear PCA. Notice that if we could invert the linear PCA step for a given instance in the reduced space, the reconstructed point would lie in feature space, not in the original space (e.g., like the one represented by an x in the diagram). Since the feature space is infinite-dimensional, we cannot compute the reconstructed point, and therefore we cannot compute the true reconstruction error. Fortunately, it is possible to find a point in the original space that would map close to the reconstructed point. This is called the reconstruction *pre-image*. Once you have this pre-image, you can measure its squared distance to the original instance. You can then select the kernel and hyperparameters that minimize this reconstruction pre-image error.

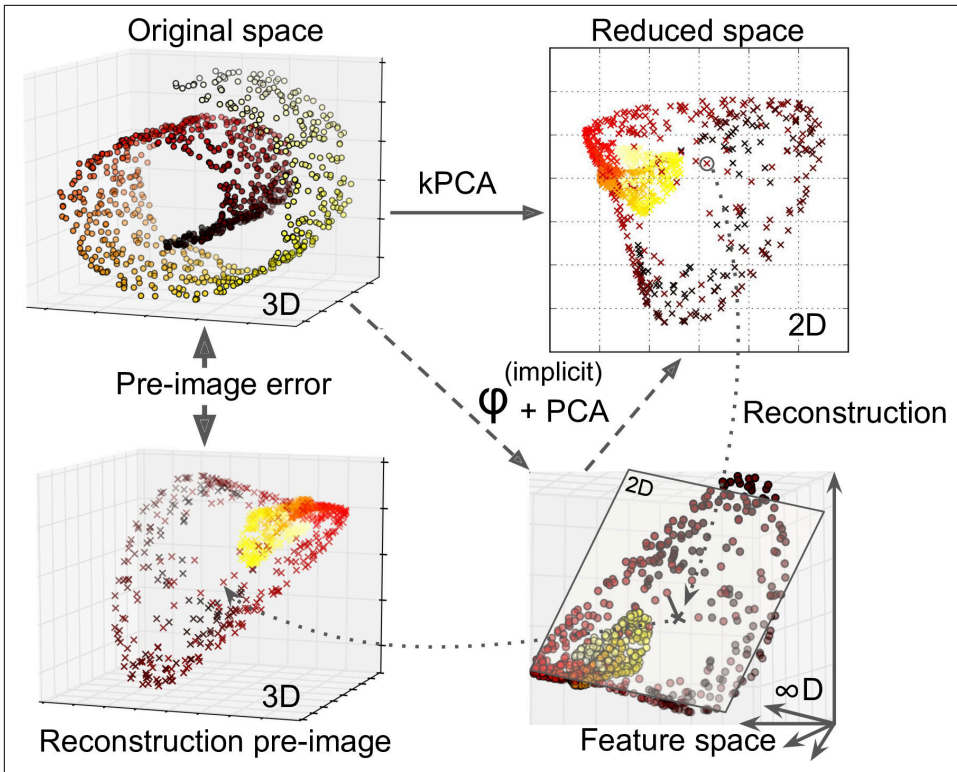

Figure 8-11. Kernel PCA and the reconstruction pre-image error

You may be wondering how to perform this reconstruction. One solution is to train a supervised regression model, with the projected instances as the training set and the original instances as the targets. Scikit-Learn will do this automatically if you set `fit_inverse_transform=True`, as shown in the following code:⁷

```
rbf_pca = KernelPCA(n_components = 2, kernel="rbf", gamma=0.0433,
                    fit_inverse_transform=True)
X_reduced = rbf_pca.fit_transform(X)
X_preimage = rbf_pca.inverse_transform(X_reduced)
```



By default, `fit_inverse_transform=False` and `KernelPCA` has no `inverse_transform()` method. This method only gets created when you set `fit_inverse_transform=True`.

⁷ Scikit-Learn uses the algorithm based on Kernel Ridge Regression described in Gokhan H. Bakır, Jason Weston, and Bernhard Scholkopf, “Learning to Find Pre-images” (Tubingen, Germany: Max Planck Institute for Biological Cybernetics, 2004).

You can then compute the reconstruction pre-image error:

```
>>> from sklearn.metrics import mean_squared_error
>>> mean_squared_error(X, X_preimage)
32.786308795766132
```

Now you can use grid search with cross-validation to find the kernel and hyperparameters that minimize this pre-image reconstruction error.

LLE

Locally Linear Embedding (LLE)⁸ is another very powerful *nonlinear dimensionality reduction* (NLDR) technique. It is a Manifold Learning technique that does not rely on projections like the previous algorithms. In a nutshell, LLE works by first measuring how each training instance linearly relates to its closest neighbors (c.n.), and then looking for a low-dimensional representation of the training set where these local relationships are best preserved (more details shortly). This makes it particularly good at unrolling twisted manifolds, especially when there is not too much noise.

For example, the following code uses Scikit-Learn's `LocallyLinearEmbedding` class to unroll the Swiss roll. The resulting 2D dataset is shown in [Figure 8-12](#). As you can see, the Swiss roll is completely unrolled and the distances between instances are locally well preserved. However, distances are not preserved on a larger scale: the left part of the unrolled Swiss roll is stretched, while the right part is squeezed. Nevertheless, LLE did a pretty good job at modeling the manifold.

```
from sklearn.manifold import LocallyLinearEmbedding

lle = LocallyLinearEmbedding(n_components=2, n_neighbors=10)
X_reduced = lle.fit_transform(X)
```

⁸ “Nonlinear Dimensionality Reduction by Locally Linear Embedding,” S. Roweis, L. Saul (2000).

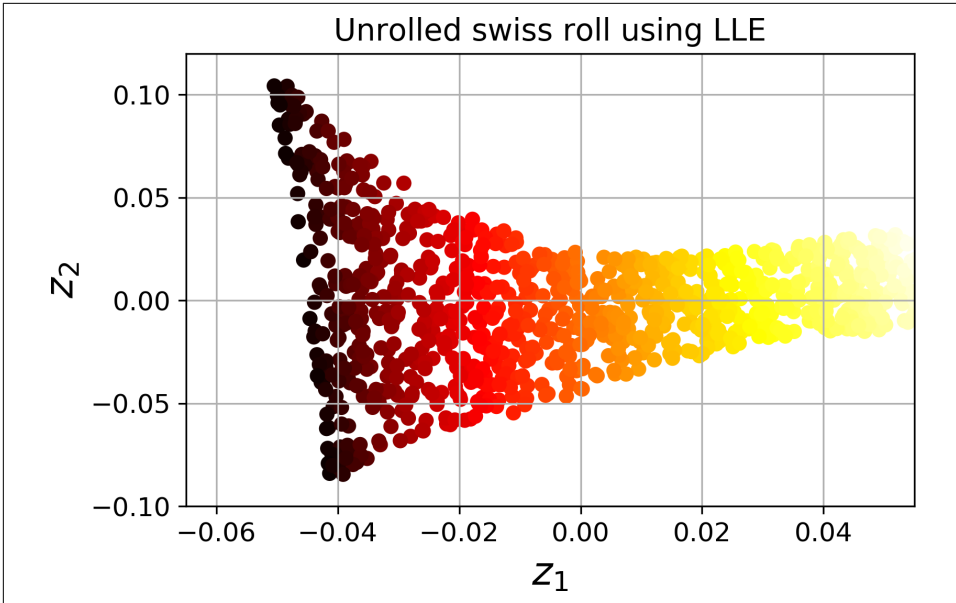

Figure 8-12. Unrolled Swiss roll using LLE

Here's how LLE works: first, for each training instance $\mathbf{x}^{(i)}$, the algorithm identifies its k closest neighbors (in the preceding code $k = 10$), then tries to reconstruct $\mathbf{x}^{(i)}$ as a linear function of these neighbors. More specifically, it finds the weights $w_{i,j}$ such that the squared distance between $\mathbf{x}^{(i)}$ and $\sum_{j=1}^m w_{i,j} \mathbf{x}^{(j)}$ is as small as possible, assuming $w_{i,j} = 0$ if $\mathbf{x}^{(i)}$ is not one of the k closest neighbors of $\mathbf{x}^{(i)}$. Thus the first step of LLE is the constrained optimization problem described in Equation 8-4, where \mathbf{W} is the weight matrix containing all the weights $w_{i,j}$. The second constraint simply normalizes the weights for each training instance $\mathbf{x}^{(i)}$.

Equation 8-4. LLE step 1: linearly modeling local relationships

$$\widehat{\mathbf{W}} = \underset{\mathbf{W}}{\operatorname{argmin}} \sum_{i=1}^m \left(\mathbf{x}^{(i)} - \sum_{j=1}^m w_{i,j} \mathbf{x}^{(j)} \right)^2$$

subject to
$$\begin{cases} w_{i,j} = 0 & \text{if } \mathbf{x}^{(j)} \text{ is not one of the } k \text{ c.n. of } \mathbf{x}^{(i)} \\ \sum_{j=1}^m w_{i,j} = 1 & \text{for } i = 1, 2, \dots, m \end{cases}$$

After this step, the weight matrix $\widehat{\mathbf{W}}$ (containing the weights $\widehat{w}_{i,j}$) encodes the local linear relationships between the training instances. Now the second step is to map the training instances into a d -dimensional space (where $d < n$) while preserving these local relationships as much as possible. If $\mathbf{z}^{(i)}$ is the image of $\mathbf{x}^{(i)}$ in this d -dimensional space, then we want the squared distance between $\mathbf{z}^{(i)}$ and $\sum_{j=1}^m \widehat{w}_{i,j} \mathbf{z}^{(j)}$ to be as small as possible. This idea leads to the unconstrained optimization problem described in [Equation 8-5](#). It looks very similar to the first step, but instead of keeping the instances fixed and finding the optimal weights, we are doing the reverse: keeping the weights fixed and finding the optimal position of the instances' images in the low-dimensional space. Note that \mathbf{Z} is the matrix containing all $\mathbf{z}^{(i)}$.

Equation 8-5. LLE step 2: reducing dimensionality while preserving relationships

$$\widehat{\mathbf{Z}} = \underset{\mathbf{Z}}{\operatorname{argmin}} \sum_{i=1}^m \left(\mathbf{z}^{(i)} - \sum_{j=1}^m \widehat{w}_{i,j} \mathbf{z}^{(j)} \right)^2$$

Scikit-Learn's LLE implementation has the following computational complexity: $O(m \log(m)n \log(k))$ for finding the k nearest neighbors, $O(mnk^3)$ for optimizing the weights, and $O(dm^2)$ for constructing the low-dimensional representations. Unfortunately, the m^2 in the last term makes this algorithm scale poorly to very large datasets.

Other Dimensionality Reduction Techniques

There are many other dimensionality reduction techniques, several of which are available in Scikit-Learn. Here are some of the most popular:

- *Multidimensional Scaling* (MDS) reduces dimensionality while trying to preserve the distances between the instances (see [Figure 8-13](#)).

- *Isomap* creates a graph by connecting each instance to its nearest neighbors, then reduces dimensionality while trying to preserve the *geodesic distances*⁹ between the instances.
- *t-Distributed Stochastic Neighbor Embedding* (t-SNE) reduces dimensionality while trying to keep similar instances close and dissimilar instances apart. It is mostly used for visualization, in particular to visualize clusters of instances in high-dimensional space (e.g., to visualize the MNIST images in 2D).
- *Linear Discriminant Analysis* (LDA) is actually a classification algorithm, but during training it learns the most discriminative axes between the classes, and these axes can then be used to define a hyperplane onto which to project the data. The benefit is that the projection will keep classes as far apart as possible, so LDA is a good technique to reduce dimensionality before running another classification algorithm such as an SVM classifier.

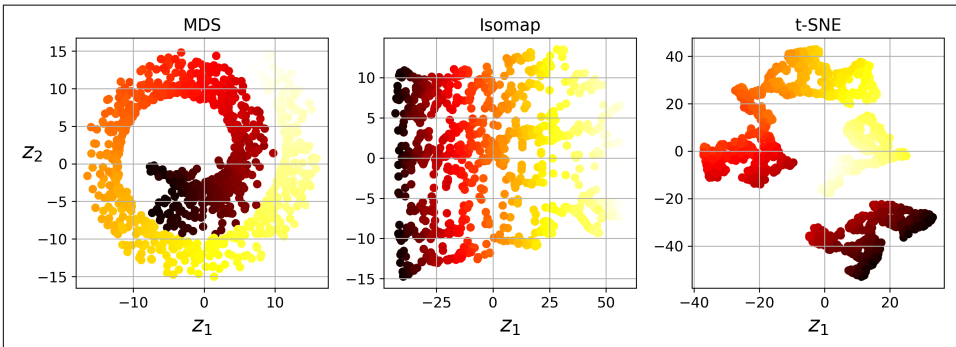

Figure 8-13. Reducing the Swiss roll to 2D using various techniques

Exercises

1. What are the main motivations for reducing a dataset's dimensionality? What are the main drawbacks?
2. What is the curse of dimensionality?
3. Once a dataset's dimensionality has been reduced, is it possible to reverse the operation? If so, how? If not, why?
4. Can PCA be used to reduce the dimensionality of a highly nonlinear dataset?
5. Suppose you perform PCA on a 1,000-dimensional dataset, setting the explained variance ratio to 95%. How many dimensions will the resulting dataset have?

⁹ The geodesic distance between two nodes in a graph is the number of nodes on the shortest path between these nodes.

6. In what cases would you use vanilla PCA, Incremental PCA, Randomized PCA, or Kernel PCA?
7. How can you evaluate the performance of a dimensionality reduction algorithm on your dataset?
8. Does it make any sense to chain two different dimensionality reduction algorithms?
9. Load the MNIST dataset (introduced in [Chapter 3](#)) and split it into a training set and a test set (take the first 60,000 instances for training, and the remaining 10,000 for testing). Train a Random Forest classifier on the dataset and time how long it takes, then evaluate the resulting model on the test set. Next, use PCA to reduce the dataset's dimensionality, with an explained variance ratio of 95%. Train a new Random Forest classifier on the reduced dataset and see how long it takes. Was training much faster? Next evaluate the classifier on the test set: how does it compare to the previous classifier?
10. Use t-SNE to reduce the MNIST dataset down to two dimensions and plot the result using Matplotlib. You can use a scatterplot using 10 different colors to represent each image's target class. Alternatively, you can write colored digits at the location of each instance, or even plot scaled-down versions of the digit images themselves (if you plot all digits, the visualization will be too cluttered, so you should either draw a random sample or plot an instance only if no other instance has already been plotted at a close distance). You should get a nice visualization with well-separated clusters of digits. Try using other dimensionality reduction algorithms such as PCA, LLE, or MDS and compare the resulting visualizations.

Solutions to these exercises are available in [???](#).

Unsupervised Learning Techniques



With Early Release ebooks, you get books in their earliest form—the author’s raw and unedited content as he or she writes—so you can take advantage of these technologies long before the official release of these titles. The following will be Chapter 9 in the final release of the book.

Although most of the applications of Machine Learning today are based on supervised learning (and as a result, this is where most of the investments go to), the vast majority of the available data is actually unlabeled: we have the input features \mathbf{X} , but we do not have the labels y . Yann LeCun famously said that “if intelligence was a cake, unsupervised learning would be the cake, supervised learning would be the icing on the cake, and reinforcement learning would be the cherry on the cake”. In other words, there is a huge potential in unsupervised learning that we have only barely started to sink our teeth into.

For example, say you want to create a system that will take a few pictures of each item on a manufacturing production line and detect which items are defective. You can fairly easily create a system that will take pictures automatically, and this might give you thousands of pictures every day. You can then build a reasonably large dataset in just a few weeks. But wait, there are no labels! If you want to train a regular binary classifier that will predict whether an item is defective or not, you will need to label every single picture as “defective” or “normal”. This will generally require human experts to sit down and manually go through all the pictures. This is a long, costly and tedious task, so it will usually only be done on a small subset of the available pictures. As a result, the labeled dataset will be quite small, and the classifier’s performance will be disappointing. Moreover, every time the company makes any change to its products, the whole process will need to be started over from scratch. Wouldn’t it

be great if the algorithm could just exploit the unlabeled data without needing humans to label every picture? Enter unsupervised learning.

In [Chapter 8](#), we looked at the most common unsupervised learning task: dimensionality reduction. In this chapter, we will look at a few more unsupervised learning tasks and algorithms:

- *Clustering*: the goal is to group similar instances together into *clusters*. This is a great tool for data analysis, customer segmentation, recommender systems, search engines, image segmentation, semi-supervised learning, dimensionality reduction, and more.
- *Anomaly detection*: the objective is to learn what “normal” data looks like, and use this to detect abnormal instances, such as defective items on a production line or a new trend in a time series.
- *Density estimation*: this is the task of estimating the *probability density function* (PDF) of the random process that generated the dataset. This is commonly used for anomaly detection: instances located in very low-density regions are likely to be anomalies. It is also useful for data analysis and visualization.

Ready for some cake? We will start with clustering, using K-Means and DBSCAN, and then we will discuss Gaussian mixture models and see how they can be used for density estimation, clustering, and anomaly detection.

Clustering

As you enjoy a hike in the mountains, you stumble upon a plant you have never seen before. You look around and you notice a few more. They are not perfectly identical, yet they are sufficiently similar for you to know that they most likely belong to the same species (or at least the same genus). You may need a botanist to tell you what species that is, but you certainly don’t need an expert to identify groups of similar-looking objects. This is called *clustering*: it is the task of identifying similar instances and assigning them to *clusters*, i.e., groups of similar instances.

Just like in classification, each instance gets assigned to a group. However, this is an unsupervised task. Consider [Figure 9-1](#): on the left is the iris dataset (introduced in [Chapter 4](#)), where each instance’s species (i.e., its class) is represented with a different marker. It is a labeled dataset, for which classification algorithms such as Logistic Regression, SVMs or Random Forest classifiers are well suited. On the right is the same dataset, but without the labels, so you cannot use a classification algorithm anymore. This is where clustering algorithms step in: many of them can easily detect the top left cluster. It is also quite easy to see with our own eyes, but it is not so obvious that the lower right cluster is actually composed of two distinct sub-clusters. That said, the dataset actually has two additional features (sepal length and width), not

represented here, and clustering algorithms can make good use of all features, so in fact they identify the three clusters fairly well (e.g., using a Gaussian mixture model, only 5 instances out of 150 are assigned to the wrong cluster).

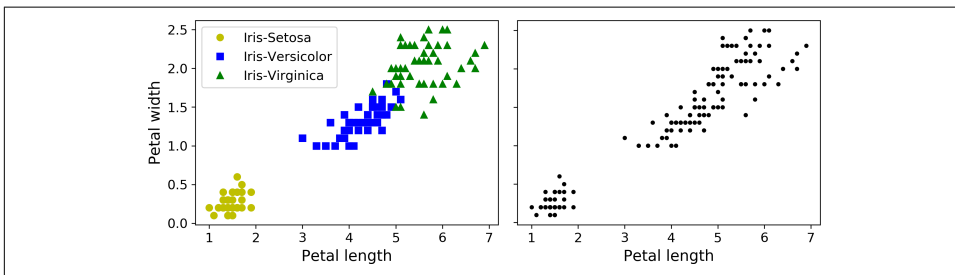

Figure 9-1. Classification (left) versus clustering (right)

Clustering is used in a wide variety of applications, including:

- For customer segmentation: you can cluster your customers based on their purchases, their activity on your website, and so on. This is useful to understand who your customers are and what they need, so you can adapt your products and marketing campaigns to each segment. For example, this can be useful in *recommender systems* to suggest content that other users in the same cluster enjoyed.
- For data analysis: when analyzing a new dataset, it is often useful to first discover clusters of similar instances, as it is often easier to analyze clusters separately.
- As a dimensionality reduction technique: once a dataset has been clustered, it is usually possible to measure each instance's *affinity* with each cluster (affinity is any measure of how well an instance fits into a cluster). Each instance's feature vector \mathbf{x} can then be replaced with the vector of its cluster affinities. If there are k clusters, then this vector is k dimensional. This is typically much lower dimensional than the original feature vector, but it can preserve enough information for further processing.
- For *anomaly detection* (also called *outlier detection*): any instance that has a low affinity to all the clusters is likely to be an anomaly. For example, if you have clustered the users of your website based on their behavior, you can detect users with unusual behavior, such as an unusual number of requests per second, and so on. Anomaly detection is particularly useful in detecting defects in manufacturing, or for *fraud detection*.
- For semi-supervised learning: if you only have a few labels, you could perform clustering and propagate the labels to all the instances in the same cluster. This can greatly increase the amount of labels available for a subsequent supervised learning algorithm, and thus improve its performance.

- For search engines: for example, some search engines let you search for images that are similar to a reference image. To build such a system, you would first apply a clustering algorithm to all the images in your database: similar images would end up in the same cluster. Then when a user provides a reference image, all you need to do is to find this image's cluster using the trained clustering model, and you can then simply return all the images from this cluster.
- To segment an image: by clustering pixels according to their color, then replacing each pixel's color with the mean color of its cluster, it is possible to reduce the number of different colors in the image considerably. This technique is used in many object detection and tracking systems, as it makes it easier to detect the contour of each object.

There is no universal definition of what a cluster is: it really depends on the context, and different algorithms will capture different kinds of clusters. For example, some algorithms look for instances centered around a particular point, called a *centroid*. Others look for continuous regions of densely packed instances: these clusters can take on any shape. Some algorithms are hierarchical, looking for clusters of clusters. And the list goes on.

In this section, we will look at two popular clustering algorithms: K-Means and DBSCAN, and we will show some of their applications, such as non-linear dimensionality reduction, semi-supervised learning and anomaly detection.

K-Means

Consider the unlabeled dataset represented in [Figure 9-2](#): you can clearly see 5 blobs of instances. The K-Means algorithm is a simple algorithm capable of clustering this kind of dataset very quickly and efficiently, often in just a few iterations. It was proposed by Stuart Lloyd at the Bell Labs in 1957 as a technique for pulse-code modulation, but it was only published outside of the company in 1982, in a paper titled “Least square quantization in PCM”.¹ By then, in 1965, Edward W. Forgy had published virtually the same algorithm, so K-Means is sometimes referred to as Lloyd-Forgy.

¹ “Least square quantization in PCM,” Stuart P. Lloyd. (1982).

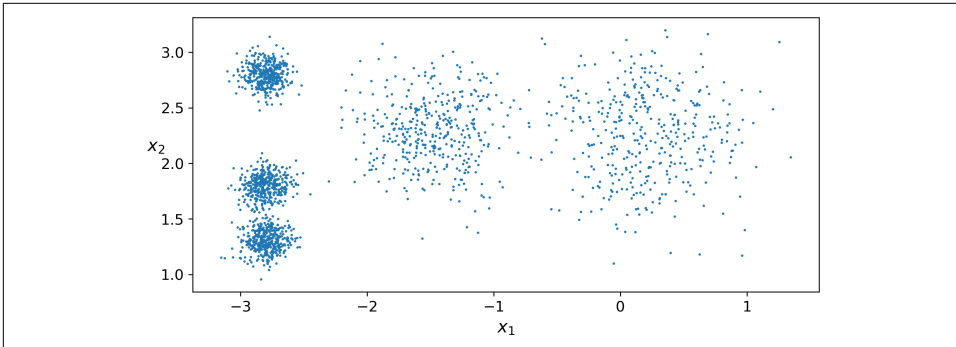

Figure 9-2. An unlabeled dataset composed of five blobs of instances

Let's train a K-Means clusterer on this dataset. It will try to find each blob's center and assign each instance to the closest blob:

```
from sklearn.cluster import KMeans
k = 5
kmeans = KMeans(n_clusters=k)
y_pred = kmeans.fit_predict(X)
```

Note that you have to specify the number of clusters k that the algorithm must find. In this example, it is pretty obvious from looking at the data that k should be set to 5, but in general it is not that easy. We will discuss this shortly.

Each instance was assigned to one of the 5 clusters. In the context of clustering, an instance's *label* is the index of the cluster that this instance gets assigned to by the algorithm: this is not to be confused with the class labels in classification (remember that clustering is an unsupervised learning task). The `KMeans` instance preserves a copy of the labels of the instances it was trained on, available via the `labels_` instance variable:

```
>>> y_pred
array([4, 0, 1, ..., 2, 1, 0], dtype=int32)
>>> y_pred is kmeans.labels_
True
```

We can also take a look at the 5 centroids that the algorithm found:

```
>>> kmeans.cluster_centers_
array([[ -2.80389616,  1.80117999],
       [  0.20876306,  2.25551336],
       [ -2.79290307,  2.79641063],
       [ -1.46679593,  2.28585348],
       [ -2.80037642,  1.30082566]])
```

Of course, you can easily assign new instances to the cluster whose centroid is closest:

```
>>> X_new = np.array([[0, 2], [3, 2], [-3, 3], [-3, 2.5]])
>>> kmeans.predict(X_new)
array([1, 1, 2, 2], dtype=int32)
```

If you plot the cluster's decision boundaries, you get a Voronoi tessellation (see [Figure 9-3](#), where each centroid is represented with an X):

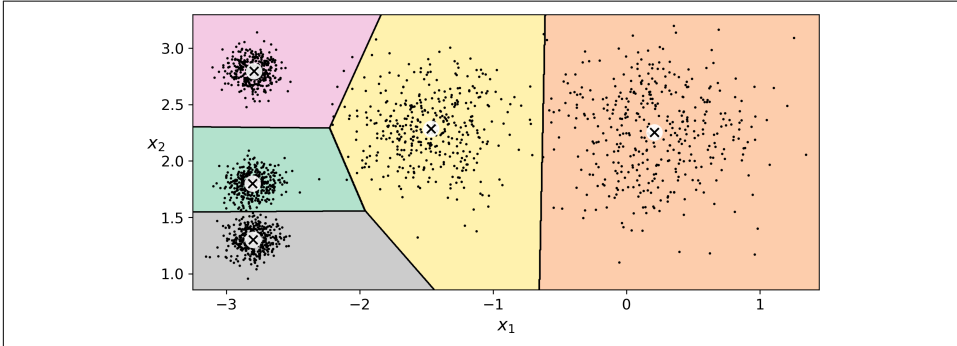

Figure 9-3. K-Means decision boundaries (Voronoi tessellation)

The vast majority of the instances were clearly assigned to the appropriate cluster, but a few instances were probably mislabeled (especially near the boundary between the top left cluster and the central cluster). Indeed, the K-Means algorithm does not behave very well when the blobs have very different diameters since all it cares about when assigning an instance to a cluster is the distance to the centroid.

Instead of assigning each instance to a single cluster, which is called *hard clustering*, it can be useful to just give each instance a score per cluster: this is called *soft clustering*. For example, the score can be the distance between the instance and the centroid, or conversely it can be a similarity score (or affinity) such as the Gaussian Radial Basis Function (introduced in [Chapter 5](#)). In the `KMeans` class, the `transform()` method measures the distance from each instance to every centroid:

```
>>> kmeans.transform(X_new)
array([[2.81093633, 0.32995317, 2.9042344 , 1.49439034, 2.88633901],
       [5.80730058, 2.80290755, 5.84739223, 4.4759332 , 5.84236351],
       [1.21475352, 3.29399768, 0.29040966, 1.69136631, 1.71086031],
       [0.72581411, 3.21806371, 0.36159148, 1.54808703, 1.21567622]])
```

In this example, the first instance in `X_new` is located at a distance of 2.81 from the first centroid, 0.33 from the second centroid, 2.90 from the third centroid, 1.49 from the fourth centroid and 2.87 from the fifth centroid. If you have a high-dimensional dataset and you transform it this way, you end up with a k -dimensional dataset: this can be a very efficient non-linear dimensionality reduction technique.

The K-Means Algorithm

So how does the algorithm work? Well it is really quite simple. Suppose you were given the centroids: you could easily label all the instances in the dataset by assigning each of them to the cluster whose centroid is closest. Conversely, if you were given all the instance labels, you could easily locate all the centroids by computing the mean of the instances for each cluster. But you are given neither the labels nor the centroids, so how can you proceed? Well, just start by placing the centroids randomly (e.g., by picking k instances at random and using their locations as centroids). Then label the instances, update the centroids, label the instances, update the centroids, and so on until the centroids stop moving. The algorithm is guaranteed to converge in a finite number of steps (usually quite small), it will not oscillate forever². You can see the algorithm in action in [Figure 9-4](#): the centroids are initialized randomly (top left), then the instances are labeled (top right), then the centroids are updated (center left), the instances are relabeled (center right), and so on. As you can see, in just 3 iterations the algorithm has reached a clustering that seems close to optimal.

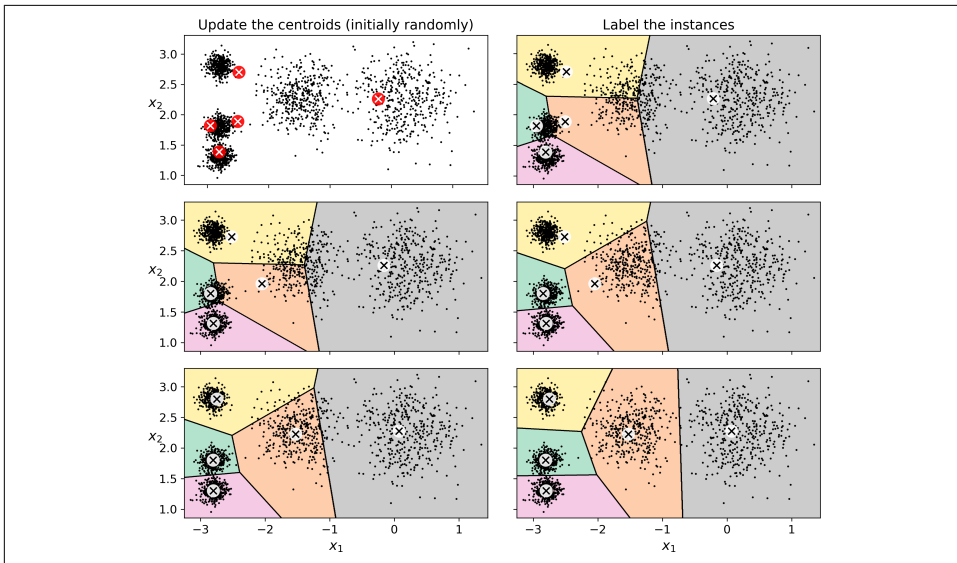

Figure 9-4. The K-Means algorithm

² This can be proven by pointing out that the mean squared distance between the instances and their closest centroid can only go down at each step.



The computational complexity of the algorithm is generally linear with regards to the number of instances m , the number of clusters k and the number of dimensions n . However, this is only true when the data has a clustering structure. If it does not, then in the worst case scenario the complexity can increase exponentially with the number of instances. In practice, however, this rarely happens, and K-Means is generally one of the fastest clustering algorithms.

Unfortunately, although the algorithm is guaranteed to converge, it may not converge to the right solution (i.e., it may converge to a local optimum): this depends on the centroid initialization. For example, [Figure 9-5](#) shows two sub-optimal solutions that the algorithm can converge to if you are not lucky with the random initialization step:

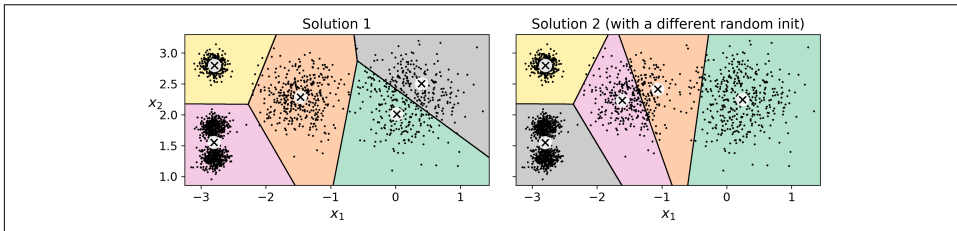

Figure 9-5. Sub-optimal solutions due to unlucky centroid initializations

Let's look at a few ways you can mitigate this risk by improving the centroid initialization.

Centroid Initialization Methods

If you happen to know approximately where the centroids should be (e.g., if you ran another clustering algorithm earlier), then you can set the `init` hyperparameter to a NumPy array containing the list of centroids, and set `n_init` to 1:

```
good_init = np.array([[ -3,  3], [ -3,  2], [ -3,  1], [ -1,  2], [  0,  2]])
kmeans = KMeans(n_clusters=5, init=good_init, n_init=1)
```

Another solution is to run the algorithm multiple times with different random initializations and keep the best solution. This is controlled by the `n_init` hyperparameter: by default, it is equal to 10, which means that the whole algorithm described earlier actually runs 10 times when you call `fit()`, and Scikit-Learn keeps the best solution. But how exactly does it know which solution is the best? Well of course it uses a performance metric! It is called the model's *inertia*: this is the mean squared distance between each instance and its closest centroid. It is roughly equal to 223.3 for the model on the left of [Figure 9-5](#), 237.5 for the model on the right of [Figure 9-5](#), and 211.6 for the model in [Figure 9-3](#). The `KMeans` class runs the algorithm `n_init` times and keeps the model with the lowest inertia: in this example, the model in [Figure 9-3](#) will be selected (unless we are very unlucky with `n_init` consecutive random initiali-

zations). If you are curious, a model's inertia is accessible via the `inertia_` instance variable:

```
>>> kmeans.inertia_  
211.59853725816856
```

The `score()` method returns the negative inertia. Why negative? Well, it is because a predictor's `score()` method must always respect the "*great is better*" rule.

```
>>> kmeans.score(X)  
-211.59853725816856
```

An important improvement to the K-Means algorithm, called *K-Means++*, was proposed in a [2006 paper](#) by David Arthur and Sergei Vassilvitskii:³ they introduced a smarter initialization step that tends to select centroids that are distant from one another, and this makes the K-Means algorithm much less likely to converge to a sub-optimal solution. They showed that the additional computation required for the smarter initialization step is well worth it since it makes it possible to drastically reduce the number of times the algorithm needs to be run to find the optimal solution. Here is the K-Means++ initialization algorithm:

- Take one centroid $\mathbf{c}^{(1)}$, chosen uniformly at random from the dataset.
- Take a new centroid $\mathbf{c}^{(i)}$, choosing an instance $\mathbf{x}^{(i)}$ with probability: $D(\mathbf{x}^{(i)})^2 / \sum_{j=1}^m D(\mathbf{x}^{(j)})^2$ where $D(\mathbf{x}^{(i)})$ is the distance between the instance $\mathbf{x}^{(i)}$ and the closest centroid that was already chosen. This probability distribution ensures that instances further away from already chosen centroids are much more likely to be selected as centroids.
- Repeat the previous step until all k centroids have been chosen.

The `KMeans` class actually uses this initialization method by default. If you want to force it to use the original method (i.e., picking k instances randomly to define the initial centroids), then you can set the `init` hyperparameter to "random". You will rarely need to do this.

Accelerated K-Means and Mini-batch K-Means

Another important improvement to the K-Means algorithm was proposed in a [2003 paper](#) by Charles Elkan.⁴ It considerably accelerates the algorithm by avoiding many unnecessary distance calculations: this is achieved by exploiting the triangle inequality.

³ "k-means++: The advantages of careful seeding," David Arthur and Sergei Vassilvitskii (2006).

⁴ "Using the Triangle Inequality to Accelerate k-Means," Charles Elkan (2003).

ity (i.e., the straight line is always the shortest⁵) and by keeping track of lower and upper bounds for distances between instances and centroids. This is the algorithm used by default by the `KMeans` class (but you can force it to use the original algorithm by setting the `algorithm` hyperparameter to "full", although you probably will never need to).

Yet another important variant of the K-Means algorithm was proposed in a [2010 paper](#) by David Sculley.⁶ Instead of using the full dataset at each iteration, the algorithm is capable of using mini-batches, moving the centroids just slightly at each iteration. This speeds up the algorithm typically by a factor of 3 or 4 and makes it possible to cluster huge datasets that do not fit in memory. Scikit-Learn implements this algorithm in the `MiniBatchKMeans` class. You can just use this class like the `KMeans` class:

```
from sklearn.cluster import MiniBatchKMeans

minibatch_kmeans = MiniBatchKMeans(n_clusters=5)
minibatch_kmeans.fit(X)
```

If the dataset does not fit in memory, the simplest option is to use the `memmap` class, as we did for incremental PCA in [Chapter 8](#). Alternatively, you can pass one mini-batch at a time to the `partial_fit()` method, but this will require much more work, since you will need to perform multiple initializations and select the best one yourself (see the notebook for an example).

Although the Mini-batch K-Means algorithm is much faster than the regular K-Means algorithm, its inertia is generally slightly worse, especially as the number of clusters increases. You can see this in [Figure 9-6](#): the plot on the left compares the inertias of Mini-batch K-Means and regular K-Means models trained on the previous dataset using various numbers of clusters k . The difference between the two curves remains fairly constant, but this difference becomes more and more significant as k increases, since the inertia becomes smaller and smaller. However, in the plot on the right, you can see that Mini-batch K-Means is much faster than regular K-Means, and this difference increases with k .

⁵ The triangle inequality is $AC \leq AB + BC$ where A, B and C are three points, and AB, AC and BC are the distances between these points.

⁶ "Web-Scale K-Means Clustering," David Sculley (2010).

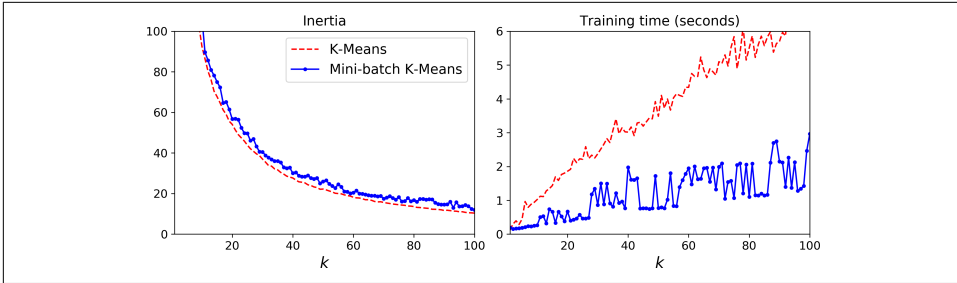

Figure 9-6. Mini-batch K-Means vs K-Means: worse inertia as k increases (left) but much faster (right)

Finding the Optimal Number of Clusters

So far, we have set the number of clusters k to 5 because it was obvious by looking at the data that this is the correct number of clusters. But in general, it will not be so easy to know how to set k , and the result might be quite bad if you set it to the wrong value. For example, as you can see in Figure 9-7, setting k to 3 or 8 results in fairly bad models:

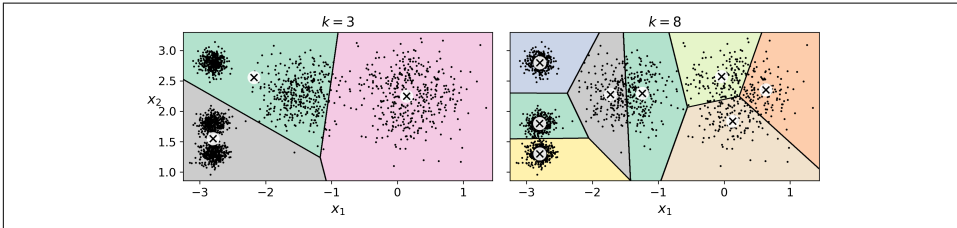

Figure 9-7. Bad choices for the number of clusters

You might be thinking that we could just pick the model with the lowest inertia, right? Unfortunately, it is not that simple. The inertia for $k=3$ is 653.2, which is much higher than for $k=5$ (which was 211.6), but with $k=8$, the inertia is just 119.1. The inertia is not a good performance metric when trying to choose k since it keeps getting lower as we increase k . Indeed, the more clusters there are, the closer each instance will be to its closest centroid, and therefore the lower the inertia will be. Let's plot the inertia as a function of k (see Figure 9-8):

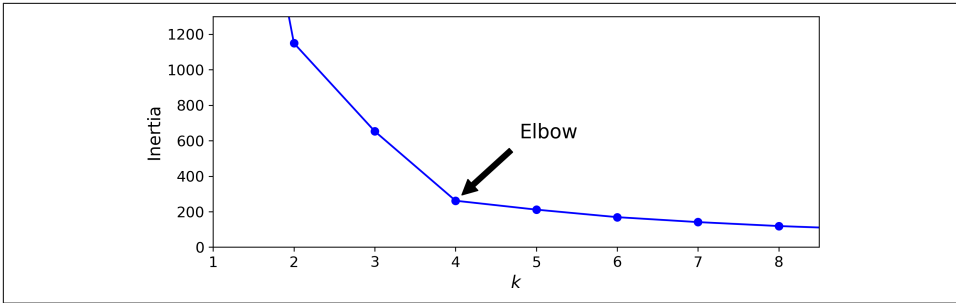

Figure 9-8. Selecting the number of clusters k using the “elbow rule”

As you can see, the inertia drops very quickly as we increase k up to 4, but then it decreases much more slowly as we keep increasing k . This curve has roughly the shape of an arm, and there is an “elbow” at $k=4$ so if we did not know better, it would be a good choice: any lower value would be dramatic, while any higher value would not help much, and we might just be splitting perfectly good clusters in half for no good reason.

This technique for choosing the best value for the number of clusters is rather coarse. A more precise approach (but also more computationally expensive) is to use the *silhouette score*, which is the mean *silhouette coefficient* over all the instances. An instance’s silhouette coefficient is equal to $(b - a) / \max(a, b)$ where a is the mean distance to the other instances in the same cluster (it is the mean intra-cluster distance), and b is the mean nearest-cluster distance, that is the mean distance to the instances of the next closest cluster (defined as the one that minimizes b , excluding the instance’s own cluster). The silhouette coefficient can vary between -1 and +1: a coefficient close to +1 means that the instance is well inside its own cluster and far from other clusters, while a coefficient close to 0 means that it is close to a cluster boundary, and finally a coefficient close to -1 means that the instance may have been assigned to the wrong cluster. To compute the silhouette score, you can use Scikit-Learn’s `silhouette_score()` function, giving it all the instances in the dataset, and the labels they were assigned:

```
>>> from sklearn.metrics import silhouette_score
>>> silhouette_score(X, kmeans.labels_)
0.655517642572828
```

Let’s compare the silhouette scores for different numbers of clusters (see [Figure 9-9](#)):

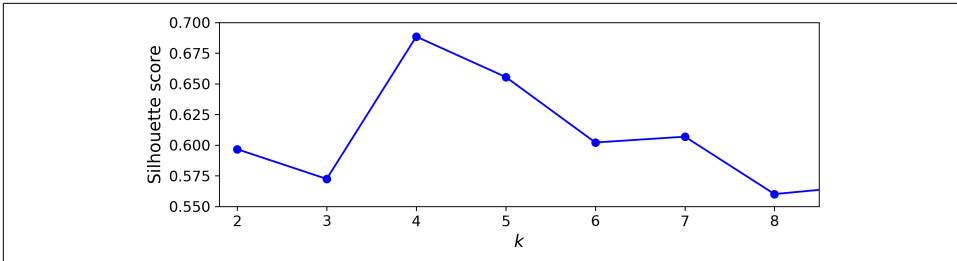

Figure 9-9. Selecting the number of clusters k using the silhouette score

As you can see, this visualization is much richer than the previous one: in particular, although it confirms that $k=4$ is a very good choice, it also underlines the fact that $k=5$ is quite good as well, and much better than $k=6$ or 7. This was not visible when comparing inertias.

An even more informative visualization is obtained when you plot every instance's silhouette coefficient, sorted by the cluster they are assigned to and by the value of the coefficient. This is called a *silhouette diagram* (see Figure 9-10):

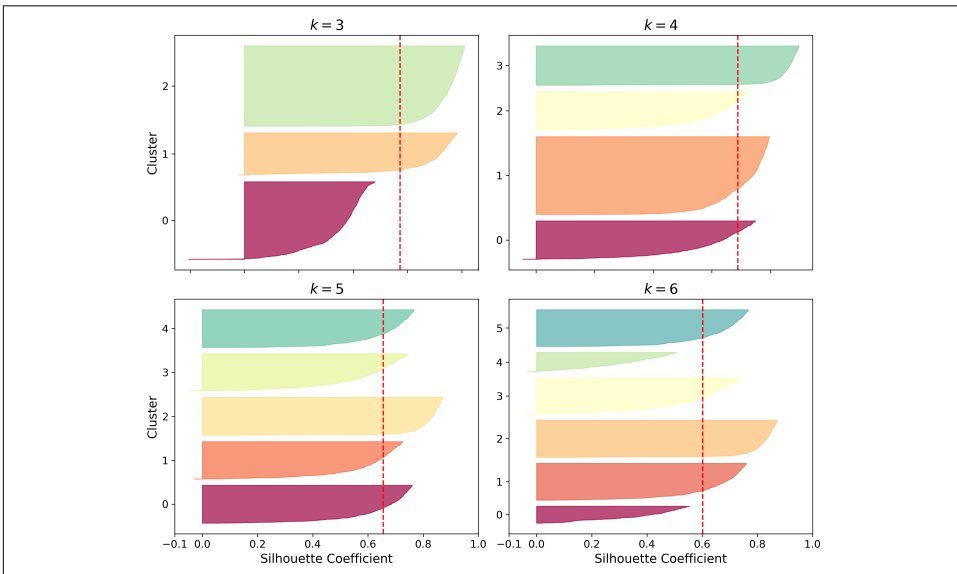

Figure 9-10. Silhouette analysis: comparing the silhouette diagrams for various values of k

The vertical dashed lines represent the silhouette score for each number of clusters. When most of the instances in a cluster have a lower coefficient than this score (i.e., if many of the instances stop short of the dashed line, ending to the left of it), then the cluster is rather bad since this means its instances are much too close to other clus-

ters. We can see that when $k=3$ and when $k=6$, we get bad clusters. But when $k=4$ or $k=5$, the clusters look pretty good – most instances extend beyond the dashed line, to the right and closer to 1.0. When $k=4$, the cluster at index 1 (the third from the top), is rather big, while when $k=5$, all clusters have similar sizes, so even though the overall silhouette score from $k=4$ is slightly greater than for $k=5$, it seems like a good idea to use $k=5$ to get clusters of similar sizes.

Limits of K-Means

Despite its many merits, most notably being fast and scalable, K-Means is not perfect. As we saw, it is necessary to run the algorithm several times to avoid sub-optimal solutions, plus you need to specify the number of clusters, which can be quite a hassle. Moreover, K-Means does not behave very well when the clusters have varying sizes, different densities, or non-spherical shapes. For example, [Figure 9-11](#) shows how K-Means clusters a dataset containing three ellipsoidal clusters of different dimensions, densities and orientations:

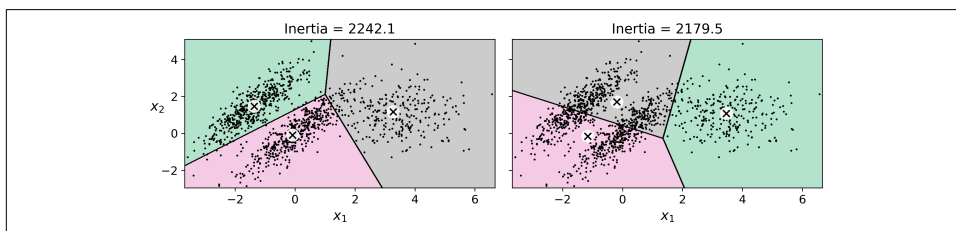

Figure 9-11. K-Means fails to cluster these ellipsoidal blobs properly

As you can see, neither of these solutions are any good. The solution on the left is better, but it still chops off 25% of the middle cluster and assigns it to the cluster on the right. The solution on the right is just terrible, even though its inertia is lower. So depending on the data, different clustering algorithms may perform better. For example, on these types of elliptical clusters, Gaussian mixture models work great.



It is important to scale the input features before you run K-Means, or else the clusters may be very stretched, and K-Means will perform poorly. Scaling the features does not guarantee that all the clusters will be nice and spherical, but it generally improves things.

Now let's look at a few ways we can benefit from clustering. We will use K-Means, but feel free to experiment with other clustering algorithms.

Using clustering for image segmentation

Image segmentation is the task of partitioning an image into multiple segments. In *semantic segmentation*, all pixels that are part of the same object type get assigned to the same segment. For example, in a self-driving car's vision system, all pixels that are part of a pedestrian's image might be assigned to the "pedestrian" segment (there would just be one segment containing all the pedestrians). In *instance segmentation*, all pixels that are part of the same individual object are assigned to the same segment. In this case there would be a different segment for each pedestrian. The state of the art in semantic or instance segmentation today is achieved using complex architectures based on convolutional neural networks (see [Chapter 14](#)). Here, we are going to do something much simpler: *color segmentation*. We will simply assign pixels to the same segment if they have a similar color. In some applications, this may be sufficient, for example if you want to analyze satellite images to measure how much total forest area there is in a region, color segmentation may be just fine.

First, let's load the image (see the upper left image in [Figure 9-12](#)) using Matplotlib's `imread()` function:

```
>>> from matplotlib.image import imread # you could also use `imageio.imread()`
>>> image = imread(os.path.join("images", "clustering", "ladybug.png"))
>>> image.shape
(533, 800, 3)
```

The image is represented as a 3D array: the first dimension's size is the height, the second is the width, and the third is the number of color channels, in this case red, green and blue (RGB). In other words, for each pixel there is a 3D vector containing the intensities of red, green and blue, each between 0.0 and 1.0 (or between 0 and 255 if you use `imageio.imread()`). Some images may have less channels, such as grayscale images (one channel), or more channels, such as images with an additional *alpha channel* for transparency, or satellite images which often contain channels for many light frequencies (e.g., infrared). The following code reshapes the array to get a long list of RGB colors, then it clusters these colors using K-Means. For example, it may identify a color cluster for all shades of green. Next, for each color (e.g., dark green), it looks for the mean color of the pixel's color cluster. For example, all shades of green may be replaced with the same light green color (assuming the mean color of the green cluster is light green). Finally it reshapes this long list of colors to get the same shape as the original image. And we're done!

```
X = image.reshape(-1, 3)
kmeans = KMeans(n_clusters=8).fit(X)
segmented_img = kmeans.cluster_centers_[kmeans.labels_]
segmented_img = segmented_img.reshape(image.shape)
```

This outputs the image shown in the upper right of [Figure 9-12](#). You can experiment with various numbers of clusters, as shown in the figure. When you use less than 8 clusters, notice that the ladybug's flashy red color fails to get a cluster of its own: it

gets merged with colors from the environment. This is due to the fact that the ladybug is quite small, much smaller than the rest of the image, so even though its color is flashy, K-Means fails to dedicate a cluster to it: as mentioned earlier, K-Means prefers clusters of similar sizes.



Figure 9-12. Image segmentation using K-Means with various numbers of color clusters

That was not too hard, was it? Now let's look at another application of clustering: preprocessing.

Using Clustering for Preprocessing

Clustering can be an efficient approach to dimensionality reduction, in particular as a preprocessing step before a supervised learning algorithm. For example, let's tackle the *digits dataset* which is a simple MNIST-like dataset containing 1,797 grayscale 8×8 images representing digits 0 to 9. First, let's load the dataset:

```
from sklearn.datasets import load_digits

X_digits, y_digits = load_digits(return_X_y=True)
```

Now, let's split it into a training set and a test set:

```
from sklearn.model_selection import train_test_split

X_train, X_test, y_train, y_test = train_test_split(X_digits, y_digits)
```

Next, let's fit a Logistic Regression model:

```
from sklearn.linear_model import LogisticRegression

log_reg = LogisticRegression(random_state=42)
log_reg.fit(X_train, y_train)
```

Let's evaluate its accuracy on the test set:

```
>>> log_reg.score(X_test, y_test)
0.9666666666666667
```

Okay, that's our baseline: 96.7% accuracy. Let's see if we can do better by using K-Means as a preprocessing step. We will create a pipeline that will first cluster the training set into 50 clusters and replace the images with their distances to these 50 clusters, then apply a logistic regression model.



Although it is tempting to define the number of clusters to 10, since there are 10 different digits, it is unlikely to perform well, because there are several different ways to write each digit.

```
from sklearn.pipeline import Pipeline

pipeline = Pipeline([
    ("kmeans", KMeans(n_clusters=50)),
    ("log_reg", LogisticRegression()),
])
pipeline.fit(X_train, y_train)
```

Now let's evaluate this classification pipeline:

```
>>> pipeline.score(X_test, y_test)
0.9822222222222222
```

How about that? We almost divided the error rate by a factor of 2!

But we chose the number of clusters k completely arbitrarily, we can surely do better. Since K-Means is just a preprocessing step in a classification pipeline, finding a good value for k is much simpler than earlier: there's no need to perform silhouette analysis or minimize the inertia, the best value of k is simply the one that results in the best classification performance during cross-validation. Let's use `GridSearchCV` to find the optimal number of clusters:

```
from sklearn.model_selection import GridSearchCV

param_grid = dict(kmeans__n_clusters=range(2, 100))
grid_clf = GridSearchCV(pipeline, param_grid, cv=3, verbose=2)
grid_clf.fit(X_train, y_train)
```

Let's look at best value for k , and the performance of the resulting pipeline:

```
>>> grid_clf.best_params_
{'kmeans__n_clusters': 90}
>>> grid_clf.score(X_test, y_test)
0.9844444444444445
```

With $k=90$ clusters, we get a small accuracy boost, reaching 98.4% accuracy on the test set. Cool!

Using Clustering for Semi-Supervised Learning

Another use case for clustering is in semi-supervised learning, when we have plenty of unlabeled instances and very few labeled instances. Let's train a logistic regression model on a sample of 50 labeled instances from the digits dataset:

```
n_labeled = 50
log_reg = LogisticRegression()
log_reg.fit(X_train[:n_labeled], y_train[:n_labeled])
```

What is the performance of this model on the test set?

```
>>> log_reg.score(X_test, y_test)
0.8266666666666667
```

The accuracy is just 82.7%: it should come as no surprise that this is much lower than earlier, when we trained the model on the full training set. Let's see how we can do better. First, let's cluster the training set into 50 clusters, then for each cluster let's find the image closest to the centroid. We will call these images the representative images:

```
k = 50
kmeans = KMeans(n_clusters=k)
X_digits_dist = kmeans.fit_transform(X_train)
representative_digit_idx = np.argmin(X_digits_dist, axis=0)
X_representative_digits = X_train[representative_digit_idx]
```

Figure 9-13 shows these 50 representative images (one per cluster):

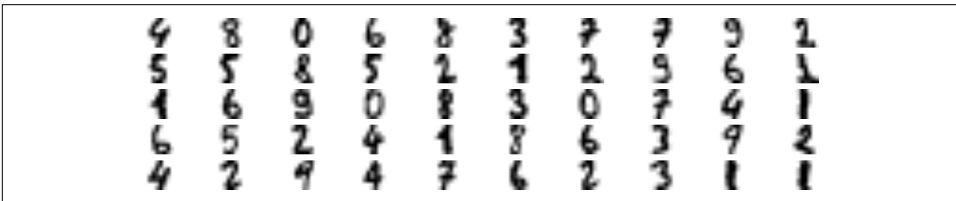

Figure 9-13. Fifty representative digit images (one per cluster)

Now let's look at each image and manually label it:

```
y_representative_digits = np.array([4, 8, 0, 6, 8, 3, ..., 7, 6, 2, 3, 1, 1])
```

Now we have a dataset with just 50 labeled instances, but instead of being completely random instances, each of them is a representative image of its cluster. Let's see if the performance is any better:

```
>>> log_reg = LogisticRegression()
>>> log_reg.fit(X_representative_digits, y_representative_digits)
>>> log_reg.score(X_test, y_test)
0.9244444444444444
```

Wow! We jumped from 82.7% accuracy to 92.4%, although we are still only training the model on 50 instances. Since it is often costly and painful to label instances, espe-

cially when it has to be done manually by experts, it is a good idea to label representative instances rather than just random instances.

But perhaps we can go one step further: what if we propagated the labels to all the other instances in the same cluster? This is called *label propagation*:

```
y_train_propagated = np.empty(len(X_train), dtype=np.int32)
for i in range(k):
    y_train_propagated[kmeans.labels_==i] = y_representative_digits[i]
```

Now let's train the model again and look at its performance:

```
>>> log_reg = LogisticRegression()
>>> log_reg.fit(X_train, y_train_propagated)
>>> log_reg.score(X_test, y_test)
0.9288888888888889
```

We got a tiny little accuracy boost. Better than nothing, but not astounding. The problem is that we propagated each representative instance's label to all the instances in the same cluster, including the instances located close to the cluster boundaries, which are more likely to be mislabeled. Let's see what happens if we only propagate the labels to the 20% of the instances that are closest to the centroids:

```
percentile_closest = 20

X_cluster_dist = X_digits_dist[np.arange(len(X_train)), kmeans.labels_]
for i in range(k):
    in_cluster = (kmeans.labels_ == i)
    cluster_dist = X_cluster_dist[in_cluster]
    cutoff_distance = np.percentile(cluster_dist, percentile_closest)
    above_cutoff = (X_cluster_dist > cutoff_distance)
    X_cluster_dist[in_cluster & above_cutoff] = -1

partially_propagated = (X_cluster_dist != -1)
X_train_partially_propagated = X_train[partially_propagated]
y_train_partially_propagated = y_train_propagated[partially_propagated]
```

Now let's train the model again on this partially propagated dataset:

```
>>> log_reg = LogisticRegression()
>>> log_reg.fit(X_train_partially_propagated, y_train_partially_propagated)
>>> log_reg.score(X_test, y_test)
0.9422222222222222
```

Nice! With just 50 labeled instances (only 5 examples per class on average!), we got 94.2% performance, which is pretty close to the performance of logistic regression on the fully labeled digits dataset (which was 96.7%). This is because the propagated labels are actually pretty good, their accuracy is very close to 99%:

```
>>> np.mean(y_train_partially_propagated == y_train[partially_propagated])
0.9896907216494846
```

Active Learning

To continue improving your model and your training set, the next step could be to do a few rounds of *active learning*: this is when a human expert interacts with the learning algorithm, providing labels when the algorithm needs them. There are many different strategies for active learning, but one of the most common ones is called *uncertainty sampling*:

- The model is trained on the labeled instances gathered so far, and this model is used to make predictions on all the unlabeled instances.
- The instances for which the model is most uncertain (i.e., when its estimated probability is lowest) must be labeled by the expert.
- Then you just iterate this process again and again, until the performance improvement stops being worth the labeling effort.

Other strategies include labeling the instances that would result in the largest model change, or the largest drop in the model's validation error, or the instances that different models disagree on (e.g., an SVM, a Random Forest, and so on).

Before we move on to Gaussian mixture models, let's take a look at DBSCAN, another popular clustering algorithm that illustrates a very different approach based on local density estimation. This approach allows the algorithm to identify clusters of arbitrary shapes.

DBSCAN

This algorithm defines clusters as continuous regions of high density. It is actually quite simple:

- For each instance, the algorithm counts how many instances are located within a small distance ϵ (epsilon) from it. This region is called the instance's *ϵ -neighborhood*.
- If an instance has at least `min_samples` instances in its ϵ -neighborhood (including itself), then it is considered a *core instance*. In other words, core instances are those that are located in dense regions.
- All instances in the neighborhood of a core instance belong to the same cluster. This may include other core instances, therefore a long sequence of neighboring core instances forms a single cluster.

- Any instance that is not a core instance and does not have one in its neighborhood is considered an anomaly.

This algorithm works well if all the clusters are dense enough, and they are well separated by low-density regions. The DBSCAN class in Scikit-Learn is as simple to use as you might expect. Let's test it on the moons dataset, introduced in [Chapter 5](#):

```
from sklearn.cluster import DBSCAN
from sklearn.datasets import make_moons

X, y = make_moons(n_samples=1000, noise=0.05)
dbscan = DBSCAN(eps=0.05, min_samples=5)
dbscan.fit(X)
```

The labels of all the instances are now available in the `labels_` instance variable:

```
>>> dbscan.labels_
array([ 0,  2, -1, -1,  1,  0,  0,  0, ...,  3,  2,  3,  3,  4,  2,  6,  3])
```

Notice that some instances have a cluster index equal to -1: this means that they are considered as anomalies by the algorithm. The indices of the core instances are available in the `core_sample_indices_` instance variable, and the core instances themselves are available in the `components_` instance variable:

```
>>> len(dbscan.core_sample_indices_)
808
>>> dbscan.core_sample_indices_
array([ 0,  4,  5,  6,  7,  8, 10, 11, ..., 992, 993, 995, 997, 998, 999])
>>> dbscan.components_
array([[ -0.02137124,  0.40618608],
       [ -0.84192557,  0.53058695],
       ...,
       [ -0.94355873,  0.3278936 ],
       [  0.79419406,  0.60777171]])
```

This clustering is represented in the left plot of [Figure 9-14](#). As you can see, it identified quite a lot of anomalies, plus 7 different clusters. How disappointing! Fortunately, if we widen each instance's neighborhood by increasing `eps` to 0.2, we get the clustering on the right, which looks perfect. Let's continue with this model.

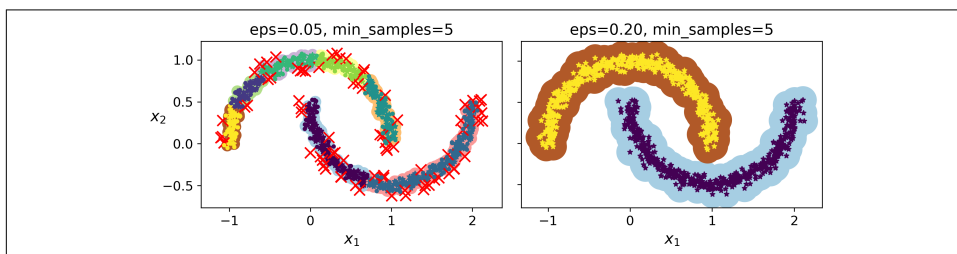

Figure 9-14. DBSCAN clustering using two different neighborhood radiuses

Somewhat surprisingly, the DBSCAN class does not have a `predict()` method, although it has a `fit_predict()` method. In other words, it cannot predict which cluster a new instance belongs to. The rationale for this decision is that several classification algorithms could make sense here, and it is easy enough to train one, for example a `KNeighborsClassifier`:

```
from sklearn.neighbors import KNeighborsClassifier

knn = KNeighborsClassifier(n_neighbors=50)
knn.fit(dbscan.components_, dbscan.labels_[dbscan.core_sample_indices_])
```

Now, given a few new instances, we can predict which cluster they most likely belong to, and even estimate a probability for each cluster. Note that we only trained them on the core instances, but we could also have chosen to train them on all the instances, or all but the anomalies: this choice depends on the final task.

```
>>> X_new = np.array([[ -0.5,  0], [ 0,  0.5], [ 1, -0.1], [ 2,  1]])
>>> knn.predict(X_new)
array([1, 0, 1, 0])
>>> knn.predict_proba(X_new)
array([[0.18, 0.82],
       [1.   , 0.   ],
       [0.12, 0.88],
       [1.   , 0.   ]])
```

The decision boundary is represented on [Figure 9-15](#) (the crosses represent the 4 instances in `X_new`). Notice that since there is no anomaly in the KNN's training set, the classifier always chooses a cluster, even when that cluster is far away. However, it is fairly straightforward to introduce a maximum distance, in which case the two instances that are far away from both clusters are classified as anomalies. To do this, we can use the `kneighbors()` method of the `KNeighborsClassifier`: given a set of instances, it returns the distances and the indices of the k nearest neighbors in the training set (two matrices, each with k columns):

```
>>> y_dist, y_pred_idx = knn.kneighbors(X_new, n_neighbors=1)
>>> y_pred = dbscan.labels_[dbscan.core_sample_indices_][y_pred_idx]
>>> y_pred[y_dist > 0.2] = -1
>>> y_pred.ravel()
array([-1,  0,  1, -1])
```

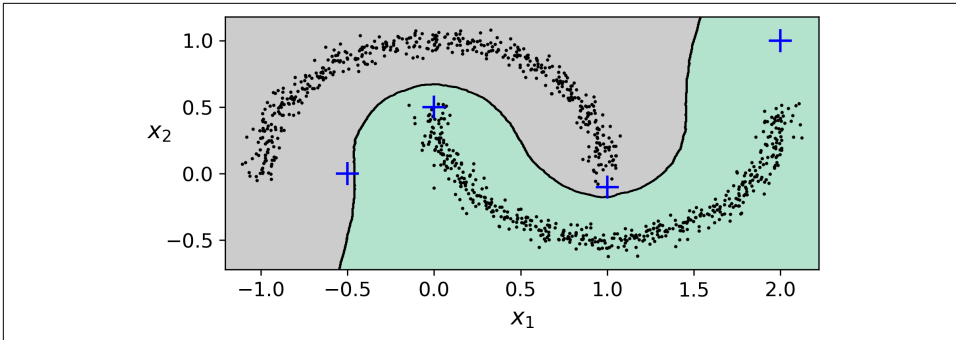

Figure 9-15. `cluster_classification_diagram`

In short, DBSCAN is a very simple yet powerful algorithm, capable of identifying any number of clusters, of any shape, it is robust to outliers, and it has just two hyper-parameters (`eps` and `min_samples`). However, if the density varies significantly across the clusters, it can be impossible for it to capture all the clusters properly. Moreover, its computational complexity is roughly $O(m \log m)$, making it pretty close to linear with regards to the number of instances. However, Scikit-Learn's implementation can require up to $O(m^2)$ memory if `eps` is large.

Other Clustering Algorithms

Scikit-Learn implements several more clustering algorithms that you should take a look at. We cannot cover them all in detail here, but here is a brief overview:

- *Agglomerative clustering*: a hierarchy of clusters is built from the bottom up. Think of many tiny bubbles floating on water and gradually attaching to each other until there's just one big group of bubbles. Similarly, at each iteration agglomerative clustering connects the nearest pair of clusters (starting with individual instances). If you draw a tree with a branch for every pair of clusters that merged, you get a binary tree of clusters, where the leaves are the individual instances. This approach scales very well to large numbers of instances or clusters, it can capture clusters of various shapes, it produces a flexible and informative cluster tree instead of forcing you to choose a particular cluster scale, and it can be used with any pairwise distance. It can scale nicely to large numbers of instances if you provide a connectivity matrix. This is a sparse m by m matrix that indicates which pairs of instances are neighbors (e.g., returned by `sklearn.neighbors.kneighbors_graph()`). Without a connectivity matrix, the algorithm does not scale well to large datasets.
- *Birch*: this algorithm was designed specifically for very large datasets, and it can be faster than batch K-Means, with similar results, as long as the number of features is not too large (<20). It builds a tree structure during training containing

just enough information to quickly assign each new instance to a cluster, without having to store all the instances in the tree: this allows it to use limited memory, while handle huge datasets.

- *Mean-shift*: this algorithm starts by placing a circle centered on each instance, then for each circle it computes the mean of all the instances located within it, and it shifts the circle so that it is centered on the mean. Next, it iterates this mean-shift step until all the circles stop moving (i.e., until each of them is centered on the mean of the instances it contains). This algorithm shifts the circles in the direction of higher density, until each of them has found a local density maximum. Finally, all the instances whose circles have settled in the same place (or close enough) are assigned to the same cluster. This has some of the same features as DBSCAN, in particular it can find any number of clusters of any shape, it has just one hyperparameter (the radius of the circles, called the bandwidth) and it relies on local density estimation. However, it tends to chop clusters into pieces when they have internal density variations. Unfortunately, its computational complexity is $O(m^2)$, so it is not suited for large datasets.
- *Affinity propagation*: this algorithm uses a voting system, where instances vote for similar instances to be their representatives, and once the algorithm converges, each representative and its voters form a cluster. This algorithm can detect any number of clusters of different sizes. Unfortunately, this algorithm has a computational complexity of $O(m^2)$, so it is not suited for large datasets.
- *Spectral clustering*: this algorithm takes a similarity matrix between the instances and creates a low-dimensional embedding from it (i.e., it reduces its dimensionality), then it uses another clustering algorithm in this low-dimensional space (Scikit-Learn's implementation uses K-Means). Spectral clustering can capture complex cluster structures, and it can also be used to cut graphs (e.g., to identify clusters of friends on a social network), however it does not scale well to large number of instances, and it does not behave well when the clusters have very different sizes.

Now let's dive into Gaussian mixture models, which can be used for density estimation, clustering and anomaly detection.

Gaussian Mixtures

A *Gaussian mixture model* (GMM) is a probabilistic model that assumes that the instances were generated from a mixture of several Gaussian distributions whose parameters are unknown. All the instances generated from a single Gaussian distribution form a cluster that typically looks like an ellipsoid. Each cluster can have a different ellipsoidal shape, size, density and orientation, just like in [Figure 9-11](#). When you observe an instance, you know it was generated from one of the Gaussian distri-

butions, but you are not told which one, and you do not know what the parameters of these distributions are.

There are several GMM variants: in the simplest variant, implemented in the `GaussianMixture` class, you must know in advance the number k of Gaussian distributions. The dataset \mathbf{X} is assumed to have been generated through the following probabilistic process:

- For each instance, a cluster is picked randomly among k clusters. The probability of choosing the j^{th} cluster is defined by the cluster's weight $\phi^{(j)}$.⁷ The index of the cluster chosen for the i^{th} instance is noted $z^{(i)}$.
- If $z^{(i)}=j$, meaning the i^{th} instance has been assigned to the j^{th} cluster, the location $\mathbf{x}^{(i)}$ of this instance is sampled randomly from the Gaussian distribution with mean $\boldsymbol{\mu}^{(j)}$ and covariance matrix $\boldsymbol{\Sigma}^{(j)}$. This is noted $\mathbf{x}^{(i)} \sim \mathcal{N}(\boldsymbol{\mu}^{(j)}, \boldsymbol{\Sigma}^{(j)})$.

This generative process can be represented as a *graphical model* (see [Figure 9-16](#)). This is a graph which represents the structure of the conditional dependencies between random variables.

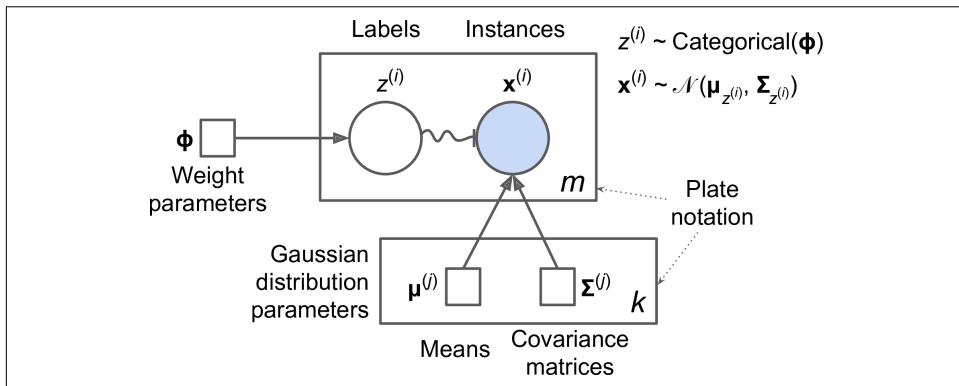

Figure 9-16. Gaussian mixture model

Here is how to interpret it:⁸

- The circles represent random variables.
- The squares represent fixed values (i.e., parameters of the model).

⁷ Phi (ϕ or φ) is the 21st letter of the Greek alphabet.

⁸ Most of these notations are standard, but a few additional notations were taken from the Wikipedia article on [plate notation](#).

- The large rectangles are called *plates*: they indicate that their content is repeated several times.
- The number indicated at the bottom right hand side of each plate indicates how many times its content is repeated, so there are m random variables $z^{(i)}$ (from $z^{(1)}$ to $z^{(m)}$) and m random variables $\mathbf{x}^{(i)}$, and k means $\boldsymbol{\mu}^{(j)}$ and k covariance matrices $\boldsymbol{\Sigma}^{(j)}$, but just one weight vector $\boldsymbol{\phi}$ (containing all the weights $\phi^{(1)}$ to $\phi^{(k)}$).
- Each variable $z^{(i)}$ is drawn from the *categorical distribution* with weights $\boldsymbol{\phi}$. Each variable $\mathbf{x}^{(i)}$ is drawn from the normal distribution with the mean and covariance matrix defined by its cluster $z^{(i)}$.
- The solid arrows represent conditional dependencies. For example, the probability distribution for each random variable $z^{(i)}$ depends on the weight vector $\boldsymbol{\phi}$. Note that when an arrow crosses a plate boundary, it means that it applies to all the repetitions of that plate, so for example the weight vector $\boldsymbol{\phi}$ conditions the probability distributions of all the random variables $\mathbf{x}^{(1)}$ to $\mathbf{x}^{(m)}$.
- The squiggly arrow from $z^{(i)}$ to $\mathbf{x}^{(i)}$ represents a switch: depending on the value of $z^{(i)}$, the instance $\mathbf{x}^{(i)}$ will be sampled from a different Gaussian distribution. For example, if $z^{(i)}=j$, then $\mathbf{x}^{(i)} \sim \mathcal{N}(\boldsymbol{\mu}^{(j)}, \boldsymbol{\Sigma}^{(j)})$.
- Shaded nodes indicate that the value is known, so in this case only the random variables $\mathbf{x}^{(i)}$ have known values: they are called *observed variables*. The unknown random variables $z^{(i)}$ are called *latent variables*.

So what can you do with such a model? Well, given the dataset \mathbf{X} , you typically want to start by estimating the weights $\boldsymbol{\phi}$ and all the distribution parameters $\boldsymbol{\mu}^{(1)}$ to $\boldsymbol{\mu}^{(k)}$ and $\boldsymbol{\Sigma}^{(1)}$ to $\boldsymbol{\Sigma}^{(k)}$. Scikit-Learn's `GaussianMixture` class makes this trivial:

```
from sklearn.mixture import GaussianMixture

gm = GaussianMixture(n_components=3, n_init=10)
gm.fit(X)
```

Let's look at the parameters that the algorithm estimated:

```
>>> gm.weights_
array([0.20965228, 0.4000662 , 0.39028152])
>>> gm.means_
array([[ 3.39909717,  1.05933727],
       [-1.40763984,  1.42710194],
       [ 0.05135313,  0.07524095]])
>>> gm.covariances_
array([[ [ 1.14807234, -0.03270354],
         [-0.03270354,  0.95496237]],

        [ [ 0.63478101,  0.72969804],
          [ 0.72969804,  1.1609872 ]],
```



```
[[ 0.68809572,  0.79608475],  
 [ 0.79608475,  1.21234145]]])
```

Great, it worked fine! Indeed, the weights that were used to generate the data were 0.2, 0.4 and 0.4, and similarly, the means and covariance matrices were very close to those found by the algorithm. But how? This class relies on the *Expectation-Maximization* (EM) algorithm, which has many similarities with the K-Means algorithm: it also initializes the cluster parameters randomly, then it repeats two steps until convergence, first assigning instances to clusters (this is called the *expectation step*) then updating the clusters (this is called the *maximization step*). Sounds familiar? Indeed, in the context of clustering you can think of EM as a generalization of K-Means which not only finds the cluster centers ($\mu^{(1)}$ to $\mu^{(k)}$), but also their size, shape and orientation ($\Sigma^{(1)}$ to $\Sigma^{(k)}$), as well as their relative weights ($\phi^{(1)}$ to $\phi^{(k)}$). Unlike K-Means, EM uses soft cluster assignments rather than hard assignments: for each instance during the expectation step, the algorithm estimates the probability that it belongs to each cluster (based on the current cluster parameters). Then, during the maximization step, each cluster is updated using *all* the instances in the dataset, with each instance weighted by the estimated probability that it belongs to that cluster. These probabilities are called the *responsibilities* of the clusters for the instances. During the maximization step, each cluster's update will mostly be impacted by the instances it is most responsible for.



Unfortunately, just like K-Means, EM can end up converging to poor solutions, so it needs to be run several times, keeping only the best solution. This is why we set `n_init` to 10. Be careful: by default `n_init` is only set to 1.

You can check whether or not the algorithm converged and how many iterations it took:

```
>>> gm.converged_  
True  
>>> gm.n_iter_  
3
```

Okay, now that you have an estimate of the location, size, shape, orientation and relative weight of each cluster, the model can easily assign each instance to the most likely cluster (hard clustering) or estimate the probability that it belongs to a particular cluster (soft clustering). For this, just use the `predict()` method for hard clustering, or the `predict_proba()` method for soft clustering:

```
>>> gm.predict(X)  
array([2, 2, 1, ..., 0, 0, 0])  
>>> gm.predict_proba(X)  
array([[2.32389467e-02,  6.77397850e-07,  9.76760376e-01],  
       [1.64685609e-02,  6.75361303e-04,  9.82856078e-01],
```

```
[2.01535333e-06, 9.99923053e-01, 7.49319577e-05],
...,
[9.99999571e-01, 2.13946075e-26, 4.28788333e-07],
[1.00000000e+00, 1.46454409e-41, 5.12459171e-16],
[1.00000000e+00, 8.02006365e-41, 2.27626238e-15]])
```

It is a *generative model*, meaning you can actually sample new instances from it (note that they are ordered by cluster index):

```
>>> X_new, y_new = gm.sample(6)
>>> X_new
array([[ 2.95400315,  2.63680992],
       [-1.16654575,  1.62792705],
       [-1.39477712, -1.48511338],
       [ 0.27221525,  0.690366  ],
       [ 0.54095936,  0.48591934],
       [ 0.38064009, -0.56240465]])

>>> y_new
array([0, 1, 2, 2, 2, 2])
```

It is also possible to estimate the density of the model at any given location. This is achieved using the `score_samples()` method: for each instance it is given, this method estimates the log of the *probability density function* (PDF) at that location. The greater the score, the higher the density:

```
>>> gm.score_samples(X)
array([-2.60782346, -3.57106041, -3.33003479, ..., -3.51352783,
       -4.39802535, -3.80743859])
```

If you compute the exponential of these scores, you get the value of the PDF at the location of the given instances. These are *not* probabilities, but *probability densities*: they can take on any positive value, not just between 0 and 1. To estimate the probability that an instance will fall within a particular region, you would have to integrate the PDF over that region (if you do so over the entire space of possible instance locations, the result will be 1).

Figure 9-17 shows the cluster means, the decision boundaries (dashed lines), and the density contours of this model:

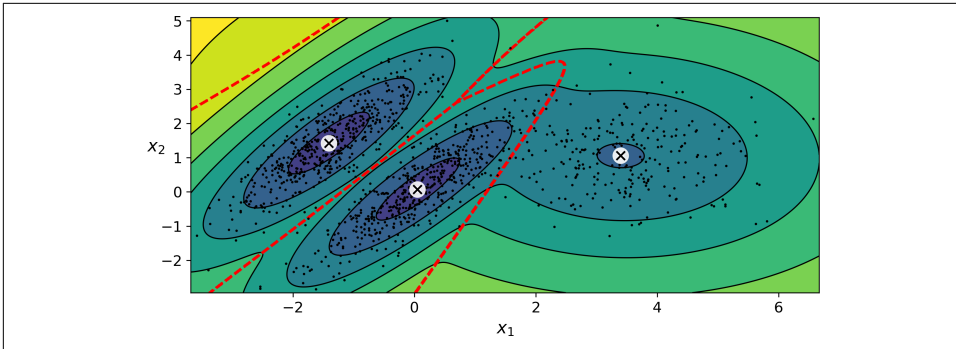

Figure 9-17. Cluster means, decision boundaries and density contours of a trained Gaussian mixture model

Nice! The algorithm clearly found an excellent solution. Of course, we made its task easy by actually generating the data using a set of 2D Gaussian distributions (unfortunately, real life data is not always so Gaussian and low-dimensional), and we also gave the algorithm the correct number of clusters. When there are many dimensions, or many clusters, or few instances, EM can struggle to converge to the optimal solution. You might need to reduce the difficulty of the task by limiting the number of parameters that the algorithm has to learn: one way to do this is to limit the range of shapes and orientations that the clusters can have. This can be achieved by imposing constraints on the covariance matrices. To do this, just set the `covariance_type` hyperparameter to one of the following values:

- "spherical": all clusters must be spherical, but they can have different diameters (i.e., different variances).
- "diag": clusters can take on any ellipsoidal shape of any size, but the ellipsoid's axes must be parallel to the coordinate axes (i.e., the covariance matrices must be diagonal).
- "tied": all clusters must have the same ellipsoidal shape, size and orientation (i.e., all clusters share the same covariance matrix).

By default, `covariance_type` is equal to "full", which means that each cluster can take on any shape, size and orientation (it has its own unconstrained covariance matrix). Figure 9-18 plots the solutions found by the EM algorithm when `covariance_type` is set to "tied" or "spherical".

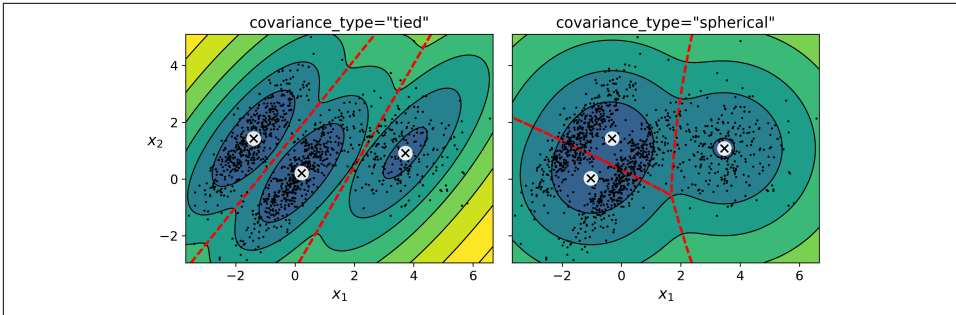

Figure 9-18. `covariance_type_diagram`



The computational complexity of training a GaussianMixture model depends on the number of instances m , the number of dimensions n , the number of clusters k , and the constraints on the covariance matrices. If `covariance_type` is "spherical" or "diag", it is $O(kmn)$, assuming the data has a clustering structure. If `covariance_type` is "tied" or "full", it is $O(kmn^2 + kn^3)$, so it will not scale to large numbers of features.

Gaussian mixture models can also be used for anomaly detection. Let's see how.

Anomaly Detection using Gaussian Mixtures

Anomaly detection (also called *outlier detection*) is the task of detecting instances that deviate strongly from the norm. These instances are of course called *anomalies* or *outliers*, while the normal instances are called *inliers*. Anomaly detection is very useful in a wide variety of applications, for example in fraud detection, or for detecting defective products in manufacturing, or to remove outliers from a dataset before training another model, which can significantly improve the performance of the resulting model.

Using a Gaussian mixture model for anomaly detection is quite simple: any instance located in a low-density region can be considered an anomaly. You must define what density threshold you want to use. For example, in a manufacturing company that tries to detect defective products, the ratio of defective products is usually well-known. Say it is equal to 4%, then you can set the density threshold to be the value that results in having 4% of the instances located in areas below that threshold density. If you notice that you get too many false positives (i.e., perfectly good products that are flagged as defective), you can lower the threshold. Conversely, if you have too many false negatives (i.e., defective products that the system does not flag as defective), you can increase the threshold. This is the usual precision/recall tradeoff (see [Chapter 3](#)). Here is how you would identify the outliers using the 4th percentile low-

est density as the threshold (i.e., approximately 4% of the instances will be flagged as anomalies):

```
densities = gm.score_samples(X)
density_threshold = np.percentile(densities, 4)
anomalies = X[densities < density_threshold]
```

These anomalies are represented as stars on **Figure 9-19**:

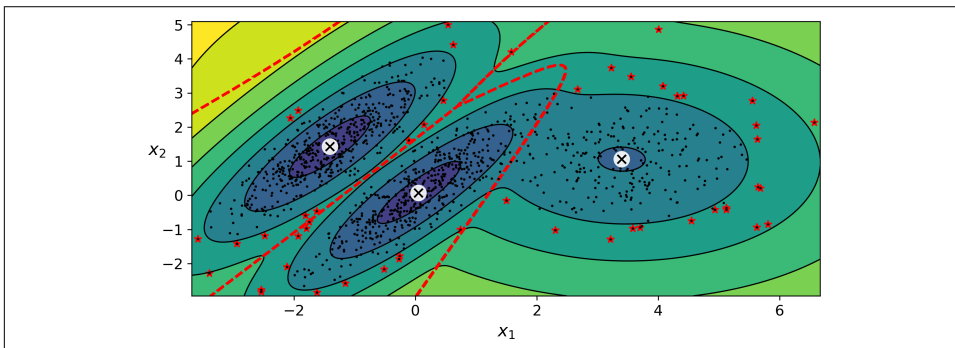

Figure 9-19. Anomaly detection using a Gaussian mixture model

A closely related task is *novelty detection*: it differs from anomaly detection in that the algorithm is assumed to be trained on a “clean” dataset, uncontaminated by outliers, whereas anomaly detection does not make this assumption. Indeed, outlier detection is often precisely used to clean up a dataset.



Gaussian mixture models try to fit all the data, including the outliers, so if you have too many of them, this will bias the model’s view of “normality”: some outliers may wrongly be considered as normal. If this happens, you can try to fit the model once, use it to detect and remove the most extreme outliers, then fit the model again on the cleaned up dataset. Another approach is to use robust covariance estimation methods (see the `EllipticEnvelope` class).

Just like K-Means, the `GaussianMixture` algorithm requires you to specify the number of clusters. So how can you find it?

Selecting the Number of Clusters

With K-Means, you could use the inertia or the silhouette score to select the appropriate number of clusters, but with Gaussian mixtures, it is not possible to use these metrics because they are not reliable when the clusters are not spherical or have different sizes. Instead, you can try to find the model that minimizes a *theoretical infor-*

mation criterion such as the *Bayesian information criterion* (BIC) or the *Akaike information criterion* (AIC), defined in [Equation 9-1](#).

Equation 9-1. Bayesian information criterion (BIC) and Akaike information criterion (AIC)

$$BIC = \log(m)p - 2 \log(\hat{L})$$

$$AIC = 2p - 2 \log(\hat{L})$$

- m is the number of instances, as always.
- p is the number of parameters learned by the model.
- \hat{L} is the maximized value of the *likelihood function* of the model.

Both the BIC and the AIC penalize models that have more parameters to learn (e.g., more clusters), and reward models that fit the data well. They often end up selecting the same model, but when they differ, the model selected by the BIC tends to be simpler (fewer parameters) than the one selected by the AIC, but it does not fit the data quite as well (this is especially true for larger datasets).

Likelihood function

The terms “probability” and “likelihood” are often used interchangeably in the English language, but they have very different meanings in statistics: given a statistical model with some parameters θ , the word “probability” is used to describe how plausible a future outcome x is (knowing the parameter values θ), while the word “likelihood” is used to describe how plausible a particular set of parameter values θ are, after the outcome x is known.

Consider a one-dimensional mixture model of two Gaussian distributions centered at -4 and $+1$. For simplicity, this toy model has a single parameter θ that controls the standard deviations of both distributions. The top left contour plot in [Figure 9-20](#) shows the entire model $f(x; \theta)$ as a function of both x and θ . To estimate the probability distribution of a future outcome x , you need to set the model parameter θ . For example, if you set it to $\theta=1.3$ (the horizontal line), you get the probability density function $f(x; \theta=1.3)$ shown in the lower left plot. Say you want to estimate the probability that x will fall between -2 and $+2$, you must calculate the integral of the PDF on this range (i.e., the surface of the shaded region). On the other hand, if you have observed a single instance $x=2.5$ (the vertical line in the upper left plot), you get the likelihood function noted $\mathcal{L}(\theta|x=2.5)=f(x=2.5; \theta)$ represented in the upper right plot.

In short, the PDF is a function of x (with θ fixed) while the likelihood function is a function of θ (with x fixed). It is important to understand that the likelihood function is *not* a probability distribution: if you integrate a probability distribution over all

possible values of x , you always get 1, but if you integrate the likelihood function over all possible values of θ , the result can be any positive value.

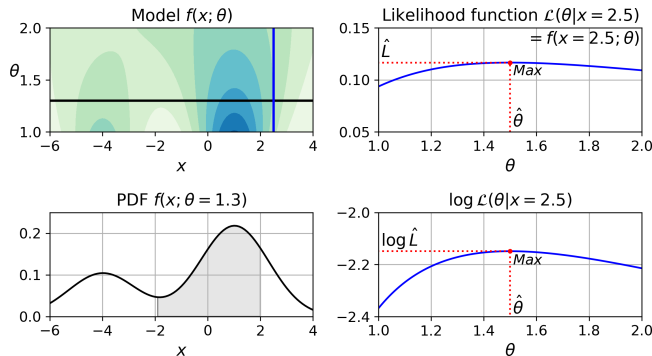

Figure 9-20. A model's parametric function (top left), and some derived functions: a PDF (lower left), a likelihood function (top right) and a log likelihood function (lower right)

Given a dataset \mathbf{X} , a common task is to try to estimate the most likely values for the model parameters. To do this, you must find the values that maximize the likelihood function, given \mathbf{X} . In this example, if you have observed a single instance $x=2.5$, the *maximum likelihood estimate* (MLE) of θ is $\hat{\theta}=1.5$. If a prior probability distribution g over θ exists, it is possible to take it into account by maximizing $\mathcal{L}(\theta|x)g(\theta)$ rather than just maximizing $\mathcal{L}(\theta|x)$. This is called maximum a-posteriori (MAP) estimation. Since MAP constrains the parameter values, you can think of it as a regularized version of MLE.

Notice that it is equivalent to maximize the likelihood function or to maximize its logarithm (represented in the lower right hand side of Figure 9-20): indeed, the logarithm is a strictly increasing function, so if θ maximizes the log likelihood, it also maximizes the likelihood. It turns out that it is generally easier to maximize the log likelihood. For example, if you observed several independent instances $x^{(1)}$ to $x^{(m)}$, you would need to find the value of θ that maximizes the product of the individual likelihood functions. But it is equivalent, and much simpler, to maximize the sum (not the product) of the log likelihood functions, thanks to the magic of the logarithm which converts products into sums: $\log(ab)=\log(a)+\log(b)$.

Once you have estimated $\hat{\theta}$, the value of θ that maximizes the likelihood function, then you are ready to compute $\hat{L} = \mathcal{L}(\hat{\theta}, \mathbf{X})$. This is the value which is used to compute the AIC and BIC: you can think of it as a measure of how well the model fits the data.

To compute the BIC and AIC, just call the `bic()` or `aic()` methods:

```

>>> gm.bic(X)
8189.74345832983
>>> gm.aic(X)
8102.518178214792

```

Figure 9-21 shows the BIC for different numbers of clusters k . As you can see, both the BIC and the AIC are lowest when $k=3$, so it is most likely the best choice. Note that we could also search for the best value for the `covariance_type` hyperparameter. For example, if it is "spherical" rather than "full", then the model has much fewer parameters to learn, but it does not fit the data as well.

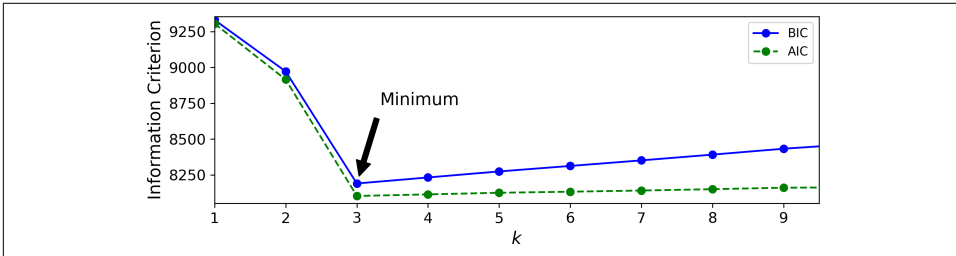

Figure 9-21. AIC and BIC for different numbers of clusters k

Bayesian Gaussian Mixture Models

Rather than manually searching for the optimal number of clusters, it is possible to use instead the `BayesianGaussianMixture` class which is capable of giving weights equal (or close) to zero to unnecessary clusters. Just set the number of clusters `n_components` to a value that you have good reason to believe is greater than the optimal number of clusters (this assumes some minimal knowledge about the problem at hand), and the algorithm will eliminate the unnecessary clusters automatically. For example, let's set the number of clusters to 10 and see what happens:

```

>>> from sklearn.mixture import BayesianGaussianMixture
>>> bgm = BayesianGaussianMixture(n_components=10, n_init=10, random_state=42)
>>> bgm.fit(X)
>>> np.round(bgm.weights_, 2)
array([[0.4 , 0.21, 0.4 , 0. , 0. , 0. , 0. , 0. , 0. , 0. ]])

```

Perfect: the algorithm automatically detected that only 3 clusters are needed, and the resulting clusters are almost identical to the ones in Figure 9-17.

In this model, the cluster parameters (including the weights, means and covariance matrices) are not treated as fixed model parameters anymore, but as latent random variables, like the cluster assignments (see Figure 9-22). So \mathbf{z} now includes both the cluster parameters and the cluster assignments.

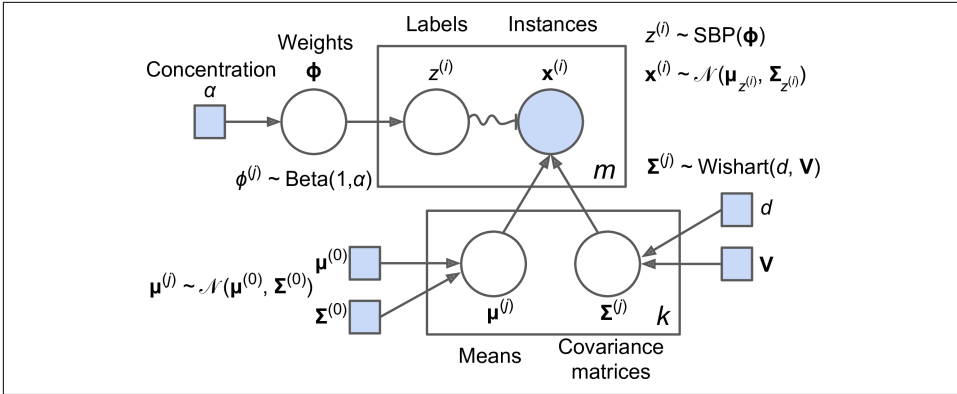

Figure 9-22. Bayesian Gaussian mixture model

Prior knowledge about the latent variables \mathbf{z} can be encoded in a probability distribution $p(\mathbf{z})$ called the *prior*. For example, we may have a prior belief that the clusters are likely to be few (low concentration), or conversely, that they are more likely to be plentiful (high concentration). This can be adjusted using the `weight_concentration_prior` hyperparameter. Setting it to 0.01 or 1000 gives very different clusterings (see Figure 9-23). However, the more data we have, the less the priors matter. In fact, to plot diagrams with such large differences, you must use very strong priors and little data.

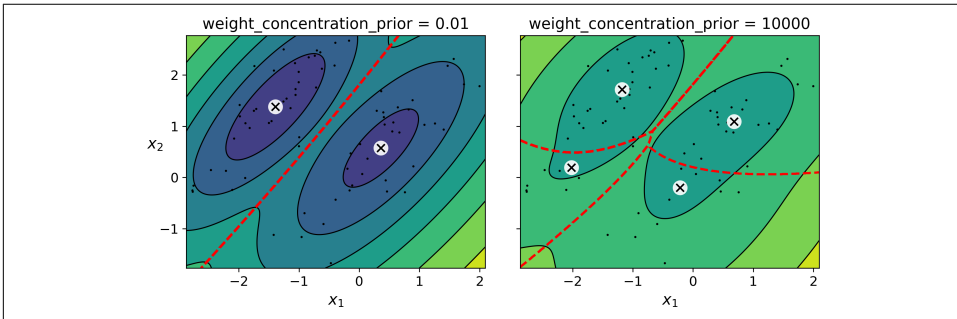

Figure 9-23. Using different concentration priors



The fact that you see only 3 regions in the right plot although there are 4 centroids is not a bug: the weight of the top-right cluster is much larger than the weight of the lower-right cluster, so the probability that any given point in this region belongs to the top-right cluster is greater than the probability that it belongs to the lower-right cluster, even near the lower-right cluster.

Bayes' theorem (Equation 9-2) tells us how to update the probability distribution over the latent variables after we observe some data \mathbf{X} . It computes the *posterior* distribution $p(\mathbf{z}|\mathbf{X})$, which is the conditional probability of \mathbf{z} given \mathbf{X} .

Equation 9-2. Bayes' theorem

$$p(\mathbf{z}|\mathbf{X}) = \text{Posterior} = \frac{\text{Likelihood} \times \text{Prior}}{\text{Evidence}} = \frac{p(\mathbf{X}|\mathbf{z})p(\mathbf{z})}{p(\mathbf{X})}$$

Unfortunately, in a Gaussian mixture model (and many other problems), the denominator $p(\mathbf{x})$ is intractable, as it requires integrating over all the possible values of \mathbf{z} (Equation 9-3). This means considering all possible combinations of cluster parameters and cluster assignments.

Equation 9-3. The evidence $p(\mathbf{X})$ is often intractable

$$p(\mathbf{X}) = \int p(\mathbf{X}|\mathbf{z})p(\mathbf{z})d\mathbf{z}$$

This is one of the central problems in Bayesian statistics, and there are several approaches to solving it. One of them is *variational inference*, which picks a family of distributions $q(\mathbf{z}; \lambda)$ with its own *variational parameters* λ (lambda), then it optimizes these parameters to make $q(\mathbf{z})$ a good approximation of $p(\mathbf{z}|\mathbf{X})$. This is achieved by finding the value of λ that minimizes the KL divergence from $q(\mathbf{z})$ to $p(\mathbf{z}|\mathbf{X})$, noted $D_{\text{KL}}(q||p)$. The KL divergence equation is shown in (see Equation 9-4), and it can be rewritten as the log of the evidence ($\log p(\mathbf{X})$) minus the *evidence lower bound* (ELBO). Since the log of the evidence does not depend on q , it is a constant term, so minimizing the KL divergence just requires maximizing the ELBO.

Equation 9-4. KL divergence from $q(\mathbf{z})$ to $p(\mathbf{z}|\mathbf{X})$

$$\begin{aligned} D_{\text{KL}}(q || p) &= \mathbb{E}_q \left[\log \frac{q(\mathbf{z})}{p(\mathbf{z}|\mathbf{X})} \right] \\ &= \mathbb{E}_q [\log q(\mathbf{z}) - \log p(\mathbf{z}|\mathbf{X})] \\ &= \mathbb{E}_q \left[\log q(\mathbf{z}) - \log \frac{p(\mathbf{z}, \mathbf{X})}{p(\mathbf{X})} \right] \\ &= \mathbb{E}_q [\log q(\mathbf{z}) - \log p(\mathbf{z}, \mathbf{X}) + \log p(\mathbf{X})] \\ &= \mathbb{E}_q [\log q(\mathbf{z})] - \mathbb{E}_q [\log p(\mathbf{z}, \mathbf{X})] + \mathbb{E}_q [\log p(\mathbf{X})] \\ &= \mathbb{E}_q [\log p(\mathbf{X})] - \left(\mathbb{E}_q [\log p(\mathbf{z}, \mathbf{X})] - \mathbb{E}_q [\log q(\mathbf{z})] \right) \\ &= \log p(\mathbf{X}) - \text{ELBO} \\ &\quad \text{where ELBO} = \mathbb{E}_q [\log p(\mathbf{z}, \mathbf{X})] - \mathbb{E}_q [\log q(\mathbf{z})] \end{aligned}$$

In practice, there are different techniques to maximize the ELBO. In *mean field variational inference*, it is necessary to pick the family of distributions $q(\mathbf{z}; \boldsymbol{\lambda})$ and the prior $p(z)$ very carefully to ensure that the equation for the ELBO simplifies to a form that can actually be computed. Unfortunately, there is no general way to do this, it depends on the task and requires some mathematical skills. For example, the distributions and lower bound equations used in Scikit-Learn's `BayesianGaussianMixture` class are presented in the [documentation](#). From these equations it is possible to derive update equations for the cluster parameters and assignment variables: these are then used very much like in the Expectation-Maximization algorithm. In fact, the computational complexity of the `BayesianGaussianMixture` class is similar to that of the `GaussianMixture` class (but generally significantly slower). A simpler approach to maximizing the ELBO is called *black box stochastic variational inference* (BBSVI): at each iteration, a few samples are drawn from q and they are used to estimate the gradients of the ELBO with regards to the variational parameters $\boldsymbol{\lambda}$, which are then used in a gradient ascent step. This approach makes it possible to use Bayesian inference with any kind of model (provided it is differentiable), even deep neural networks: this is called Bayesian deep learning.



If you want to dive deeper into Bayesian statistics, check out the [Bayesian Data Analysis](#) book by Andrew Gelman, John Carlin, Hal Stern, David Dunson, Aki Vehtari, and Donald Rubin.

Gaussian mixture models work great on clusters with ellipsoidal shapes, but if you try to fit a dataset with different shapes, you may have bad surprises. For example, let's see what happens if we use a Bayesian Gaussian mixture model to cluster the moons dataset (see [Figure 9-24](#)):

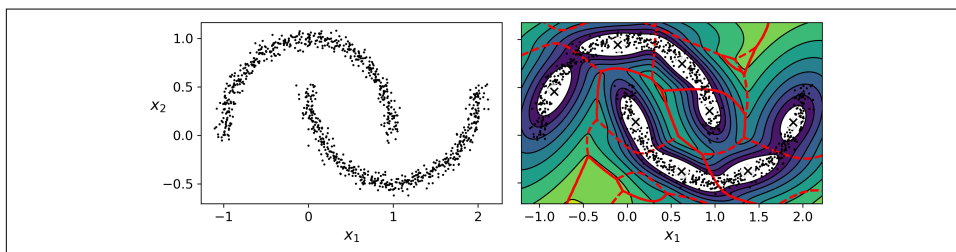

Figure 9-24. `moons_vs_bgm_diagram`

Oops, the algorithm desperately searched for ellipsoids, so it found 8 different clusters instead of 2. The density estimation is not too bad, so this model could perhaps be used for anomaly detection, but it failed to identify the two moons. Let's now look at a few clustering algorithms capable of dealing with arbitrarily shaped clusters.

Other Anomaly Detection and Novelty Detection Algorithms

Scikit-Learn also implements a few algorithms dedicated to anomaly detection or novelty detection:

- *Fast-MCD* (minimum covariance determinant), implemented by the `EllipticEnvelope` class: this algorithm is useful for outlier detection, in particular to cleanup a dataset. It assumes that the normal instances (inliers) are generated from a single Gaussian distribution (not a mixture), but it also assumes that the dataset is contaminated with outliers that were not generated from this Gaussian distribution. When it estimates the parameters of the Gaussian distribution (i.e., the shape of the elliptic envelope around the inliers), it is careful to ignore the instances that are most likely outliers. This gives a better estimation of the elliptic envelope, and thus makes it better at identifying the outliers.
- *Isolation forest*: this is an efficient algorithm for outlier detection, especially in high-dimensional datasets. The algorithm builds a Random Forest in which each Decision Tree is grown randomly: at each node, it picks a feature randomly, then it picks a random threshold value (between the min and max value) to split the dataset in two. The dataset gradually gets chopped into pieces this way, until all instances end up isolated from the other instances. An anomaly is usually far from other instances, so on average (across all the Decision Trees) it tends to get isolated in less steps than normal instances.
- *Local outlier factor* (LOF): this algorithm is also good for outlier detection. It compares the density of instances around a given instance to the density around its neighbors. An anomaly is often more isolated than its k nearest neighbors.
- *One-class SVM*: this algorithm is better suited for novelty detection. Recall that a kernelized SVM classifier separates two classes by first (implicitly) mapping all the instances to a high-dimensional space, then separating the two classes using a linear SVM classifier within this high-dimensional space (see [Chapter 5](#)). Since we just have one class of instances, the one-class SVM algorithm instead tries to separate the instances in high-dimensional space from the origin. In the original space, this will correspond to finding a small region that encompasses all the instances. If a new instance does not fall within this region, it is an anomaly. There are a few hyperparameters to tweak: the usual ones for a kernelized SVM, plus a margin hyperparameter that corresponds to the probability of a new instance being mistakenly considered as novel, when it is in fact normal. It works great, especially with high-dimensional datasets, but just like all SVMs, it does not scale to large datasets.

PART II

Neural Networks and Deep Learning

Introduction to Artificial Neural Networks with Keras



With Early Release ebooks, you get books in their earliest form—the author’s raw and unedited content as he or she writes—so you can take advantage of these technologies long before the official release of these titles. The following will be Chapter 10 in the final release of the book.

Birds inspired us to fly, burdock plants inspired velcro, and countless more inventions were inspired by nature. It seems only logical, then, to look at the brain’s architecture for inspiration on how to build an intelligent machine. This is the key idea that sparked *artificial neural networks* (ANNs). However, although planes were inspired by birds, they don’t have to flap their wings. Similarly, ANNs have gradually become quite different from their biological cousins. Some researchers even argue that we should drop the biological analogy altogether (e.g., by saying “units” rather than “neurons”), lest we restrict our creativity to biologically plausible systems.¹

ANNs are at the very core of Deep Learning. They are versatile, powerful, and scalable, making them ideal to tackle large and highly complex Machine Learning tasks, such as classifying billions of images (e.g., Google Images), powering speech recognition services (e.g., Apple’s Siri), recommending the best videos to watch to hundreds of millions of users every day (e.g., YouTube), or learning to beat the world champion at the game of *Go* by playing millions of games against itself (DeepMind’s AlphaZero).

¹ You can get the best of both worlds by being open to biological inspirations without being afraid to create biologically unrealistic models, as long as they work well.

In the first part of this chapter, we will introduce artificial neural networks, starting with a quick tour of the very first ANN architectures, leading up to *Multi-Layer Perceptrons* (MLPs) which are heavily used today (other architectures will be explored in the next chapters). In the second part, we will look at how to implement neural networks using the popular Keras API. This is a beautifully designed and simple high-level API for building, training, evaluating and running neural networks. But don't be fooled by its simplicity: it is expressive and flexible enough to let you build a wide variety of neural network architectures. In fact, it will probably be sufficient for most of your use cases. Moreover, should you ever need extra flexibility, you can always write custom Keras components using its lower-level API, as we will see in [Chapter 12](#).

But first, let's go back in time to see how artificial neural networks came to be!

From Biological to Artificial Neurons

Surprisingly, ANNs have been around for quite a while: they were first introduced back in 1943 by the neurophysiologist Warren McCulloch and the mathematician Walter Pitts. In their [landmark paper](#),² "A Logical Calculus of Ideas Immanent in Nervous Activity," McCulloch and Pitts presented a simplified computational model of how biological neurons might work together in animal brains to perform complex computations using *propositional logic*. This was the first artificial neural network architecture. Since then many other architectures have been invented, as we will see.

The early successes of ANNs until the 1960s led to the widespread belief that we would soon be conversing with truly intelligent machines. When it became clear that this promise would go unfulfilled (at least for quite a while), funding flew elsewhere and ANNs entered a long winter. In the early 1980s there was a revival of interest in *connectionism* (the study of neural networks), as new architectures were invented and better training techniques were developed. But progress was slow, and by the 1990s other powerful Machine Learning techniques were invented, such as Support Vector Machines (see [Chapter 5](#)). These techniques seemed to offer better results and stronger theoretical foundations than ANNs, so once again the study of neural networks entered a long winter.

Finally, we are now witnessing yet another wave of interest in ANNs. Will this wave die out like the previous ones did? Well, there are a few good reasons to believe that this wave is different and that it will have a much more profound impact on our lives:

² "A Logical Calculus of Ideas Immanent in Nervous Activity," W. McCulloch and W. Pitts (1943).

- There is now a huge quantity of data available to train neural networks, and ANNs frequently outperform other ML techniques on very large and complex problems.
- The tremendous increase in computing power since the 1990s now makes it possible to train large neural networks in a reasonable amount of time. This is in part due to Moore's Law, but also thanks to the gaming industry, which has produced powerful GPU cards by the millions.
- The training algorithms have been improved. To be fair they are only slightly different from the ones used in the 1990s, but these relatively small tweaks have a huge positive impact.
- Some theoretical limitations of ANNs have turned out to be benign in practice. For example, many people thought that ANN training algorithms were doomed because they were likely to get stuck in local optima, but it turns out that this is rather rare in practice (or when it is the case, they are usually fairly close to the global optimum).
- ANNs seem to have entered a virtuous circle of funding and progress. Amazing products based on ANNs regularly make the headline news, which pulls more and more attention and funding toward them, resulting in more and more progress, and even more amazing products.

Biological Neurons

Before we discuss artificial neurons, let's take a quick look at a biological neuron (represented in [Figure 10-1](#)). It is an unusual-looking cell mostly found in animal cerebral cortexes (e.g., your brain), composed of a *cell body* containing the nucleus and most of the cell's complex components, and many branching extensions called *dendrites*, plus one very long extension called the *axon*. The axon's length may be just a few times longer than the cell body, or up to tens of thousands of times longer. Near its extremity the axon splits off into many branches called *telodendria*, and at the tip of these branches are minuscule structures called *synaptic terminals* (or simply *synapses*), which are connected to the dendrites (or directly to the cell body) of other neurons. Biological neurons receive short electrical impulses called *signals* from other neurons via these synapses. When a neuron receives a sufficient number of signals from other neurons within a few milliseconds, it fires its own signals.

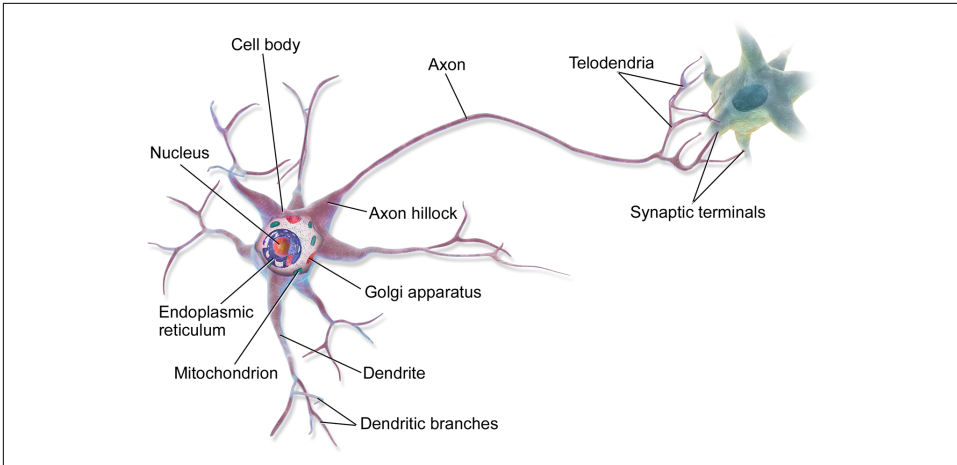

Figure 10-1. Biological neuron³

Thus, individual biological neurons seem to behave in a rather simple way, but they are organized in a vast network of billions of neurons, each neuron typically connected to thousands of other neurons. Highly complex computations can be performed by a vast network of fairly simple neurons, much like a complex anthill can emerge from the combined efforts of simple ants. The architecture of biological neural networks (BNN)⁴ is still the subject of active research, but some parts of the brain have been mapped, and it seems that neurons are often organized in consecutive layers, as shown in Figure 10-2.

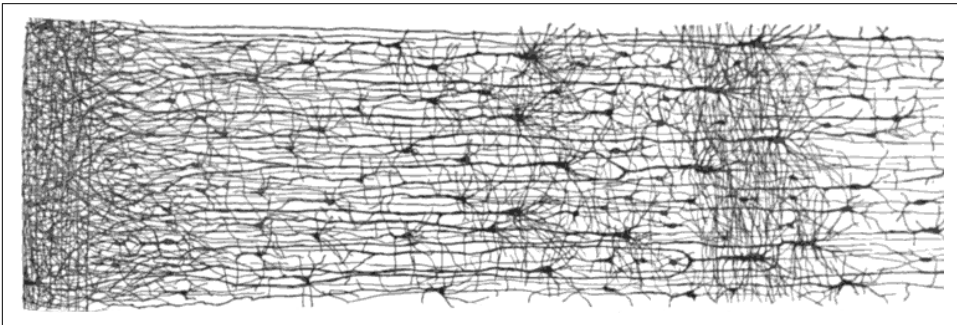

Figure 10-2. Multiple layers in a biological neural network (human cortex)⁵

3 Image by Bruce Blaus (Creative Commons 3.0). Reproduced from <https://en.wikipedia.org/wiki/Neuron>.

4 In the context of Machine Learning, the phrase “neural networks” generally refers to ANNs, not BNNs.

5 Drawing of a cortical lamination by S. Ramon y Cajal (public domain). Reproduced from https://en.wikipedia.org/wiki/Cerebral_cortex.

Logical Computations with Neurons

Warren McCulloch and Walter Pitts proposed a very simple model of the biological neuron, which later became known as an *artificial neuron*: it has one or more binary (on/off) inputs and one binary output. The artificial neuron simply activates its output when more than a certain number of its inputs are active. McCulloch and Pitts showed that even with such a simplified model it is possible to build a network of artificial neurons that computes any logical proposition you want. For example, let's build a few ANNs that perform various logical computations (see [Figure 10-3](#)), assuming that a neuron is activated when at least two of its inputs are active.

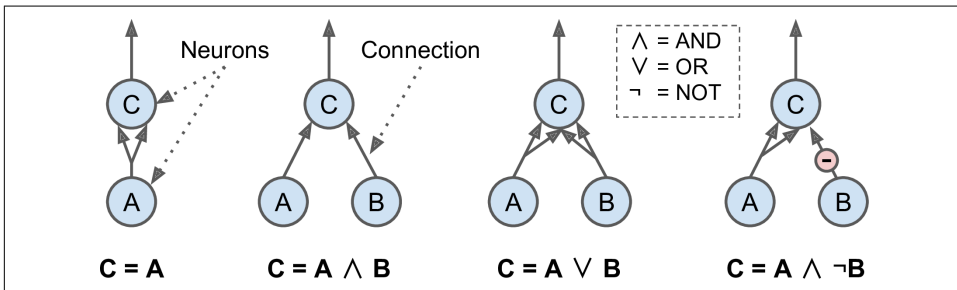

Figure 10-3. ANNs performing simple logical computations

- The first network on the left is simply the identity function: if neuron A is activated, then neuron C gets activated as well (since it receives two input signals from neuron A), but if neuron A is off, then neuron C is off as well.
- The second network performs a logical AND: neuron C is activated only when both neurons A and B are activated (a single input signal is not enough to activate neuron C).
- The third network performs a logical OR: neuron C gets activated if either neuron A or neuron B is activated (or both).
- Finally, if we suppose that an input connection can inhibit the neuron's activity (which is the case with biological neurons), then the fourth network computes a slightly more complex logical proposition: neuron C is activated only if neuron A is active and if neuron B is off. If neuron A is active all the time, then you get a logical NOT: neuron C is active when neuron B is off, and vice versa.

You can easily imagine how these networks can be combined to compute complex logical expressions (see the exercises at the end of the chapter).

The Perceptron

The *Perceptron* is one of the simplest ANN architectures, invented in 1957 by Frank Rosenblatt. It is based on a slightly different artificial neuron (see [Figure 10-4](#)) called

a *threshold logic unit* (TLU), or sometimes a *linear threshold unit* (LTU): the inputs and output are now numbers (instead of binary on/off values) and each input connection is associated with a weight. The TLU computes a weighted sum of its inputs ($z = w_1 x_1 + w_2 x_2 + \dots + w_n x_n = \mathbf{x}^T \mathbf{w}$), then applies a *step function* to that sum and outputs the result: $h_{\mathbf{w}}(\mathbf{x}) = \text{step}(z)$, where $z = \mathbf{x}^T \mathbf{w}$.

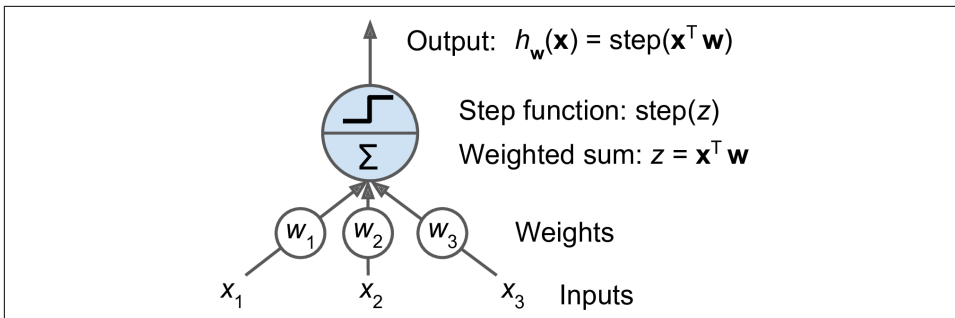

Figure 10-4. Threshold logic unit

The most common step function used in Perceptrons is the *Heaviside step function* (see Equation 10-1). Sometimes the sign function is used instead.

Equation 10-1. Common step functions used in Perceptrons

$$\text{heaviside}(z) = \begin{cases} 0 & \text{if } z < 0 \\ 1 & \text{if } z \geq 0 \end{cases} \quad \text{sgn}(z) = \begin{cases} -1 & \text{if } z < 0 \\ 0 & \text{if } z = 0 \\ +1 & \text{if } z > 0 \end{cases}$$

A single TLU can be used for simple linear binary classification. It computes a linear combination of the inputs and if the result exceeds a threshold, it outputs the positive class or else outputs the negative class (just like a Logistic Regression classifier or a linear SVM). For example, you could use a single TLU to classify iris flowers based on the petal length and width (also adding an extra bias feature $x_0 = 1$, just like we did in previous chapters). Training a TLU in this case means finding the right values for w_0 , w_1 , and w_2 (the training algorithm is discussed shortly).

A Perceptron is simply composed of a single layer of TLUs,⁶ with each TLU connected to all the inputs. When all the neurons in a layer are connected to every neuron in the previous layer (i.e., its input neurons), it is called a *fully connected layer* or a *dense layer*. To represent the fact that each input is sent to every TLU, it is common to draw special passthrough neurons called *input neurons*: they just output whatever input they are fed. All the input neurons form the *input layer*. Moreover, an extra bias fea-

⁶ The name *Perceptron* is sometimes used to mean a tiny network with a single TLU.

ture is generally added ($x_0 = 1$): it is typically represented using a special type of neuron called a *bias neuron*, which just outputs 1 all the time. A Perceptron with two inputs and three outputs is represented in [Figure 10-5](#). This Perceptron can classify instances simultaneously into three different binary classes, which makes it a multi-output classifier.

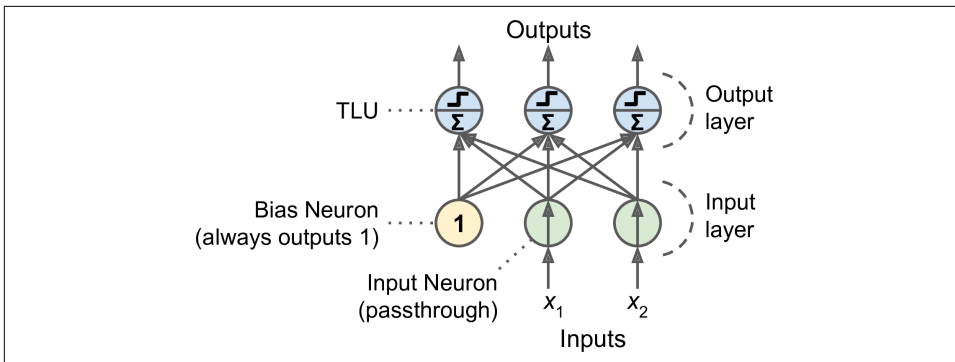

Figure 10-5. Perceptron diagram

Thanks to the magic of linear algebra, it is possible to efficiently compute the outputs of a layer of artificial neurons for several instances at once, by using [Equation 10-2](#):

Equation 10-2. Computing the outputs of a fully connected layer

$$h_{\mathbf{W}, \mathbf{b}}(\mathbf{X}) = \phi(\mathbf{X}\mathbf{W} + \mathbf{b})$$

- As always, \mathbf{X} represents the matrix of input features. It has one row per instance, one column per feature.
- The weight matrix \mathbf{W} contains all the connection weights except for the ones from the bias neuron. It has one row per input neuron and one column per artificial neuron in the layer.
- The bias vector \mathbf{b} contains all the connection weights between the bias neuron and the artificial neurons. It has one bias term per artificial neuron.
- The function ϕ is called the *activation function*: when the artificial neurons are TLUs, it is a step function (but we will discuss other activation functions shortly).

So how is a Perceptron trained? The Perceptron training algorithm proposed by Frank Rosenblatt was largely inspired by *Hebb's rule*. In his book *The Organization of Behavior*, published in 1949, Donald Hebb suggested that when a biological neuron often triggers another neuron, the connection between these two neurons grows stronger. This idea was later summarized by Siegrid Löwel in this catchy phrase: “Cells that fire together, wire together.” This rule later became known as Hebb's rule

(or *Hebbian learning*); that is, the connection weight between two neurons is increased whenever they have the same output. Perceptrons are trained using a variant of this rule that takes into account the error made by the network; it reinforces connections that help reduce the error. More specifically, the Perceptron is fed one training instance at a time, and for each instance it makes its predictions. For every output neuron that produced a wrong prediction, it reinforces the connection weights from the inputs that would have contributed to the correct prediction. The rule is shown in [Equation 10-3](#).

Equation 10-3. Perceptron learning rule (weight update)

$$w_{i,j}^{(\text{next step})} = w_{i,j} + \eta(y_j - \hat{y}_j)x_i$$

- $w_{i,j}$ is the connection weight between the i^{th} input neuron and the j^{th} output neuron.
- x_i is the i^{th} input value of the current training instance.
- \hat{y}_j is the output of the j^{th} output neuron for the current training instance.
- y_j is the target output of the j^{th} output neuron for the current training instance.
- η is the learning rate.

The decision boundary of each output neuron is linear, so Perceptrons are incapable of learning complex patterns (just like Logistic Regression classifiers). However, if the training instances are linearly separable, Rosenblatt demonstrated that this algorithm would converge to a solution.⁷ This is called the *Perceptron convergence theorem*.

Scikit-Learn provides a Perceptron class that implements a single TLU network. It can be used pretty much as you would expect—for example, on the iris dataset (introduced in [Chapter 4](#)):

```
import numpy as np
from sklearn.datasets import load_iris
from sklearn.linear_model import Perceptron

iris = load_iris()
X = iris.data[:, (2, 3)] # petal length, petal width
y = (iris.target == 0).astype(np.int) # Iris Setosa?

per_clf = Perceptron()
per_clf.fit(X, y)
```

⁷ Note that this solution is generally not unique: in general when the data are linearly separable, there is an infinity of hyperplanes that can separate them.

```
y_pred = per_clf.predict([[2, 0.5]])
```

You may have noticed the fact that the Perceptron learning algorithm strongly resembles Stochastic Gradient Descent. In fact, Scikit-Learn's Perceptron class is equivalent to using an `SGDClassifier` with the following hyperparameters: `loss="perceptron"`, `learning_rate="constant"`, `eta=1` (the learning rate), and `penalty=None` (no regularization).

Note that contrary to Logistic Regression classifiers, Perceptrons do not output a class probability; rather, they just make predictions based on a hard threshold. This is one of the good reasons to prefer Logistic Regression over Perceptrons.

In their 1969 monograph titled *Perceptrons*, Marvin Minsky and Seymour Papert highlighted a number of serious weaknesses of Perceptrons, in particular the fact that they are incapable of solving some trivial problems (e.g., the *Exclusive OR* (XOR) classification problem; see the left side of [Figure 10-6](#)). Of course this is true of any other linear classification model as well (such as Logistic Regression classifiers), but researchers had expected much more from Perceptrons, and their disappointment was great, and many researchers dropped neural networks altogether in favor of higher-level problems such as logic, problem solving, and search.

However, it turns out that some of the limitations of Perceptrons can be eliminated by stacking multiple Perceptrons. The resulting ANN is called a *Multi-Layer Perceptron* (MLP). In particular, an MLP can solve the XOR problem, as you can verify by computing the output of the MLP represented on the right of [Figure 10-6](#): with inputs (0, 0) or (1, 1) the network outputs 0, and with inputs (0, 1) or (1, 0) it outputs 1. All connections have a weight equal to 1, except the four connections where the weight is shown. Try verifying that this network indeed solves the XOR problem!

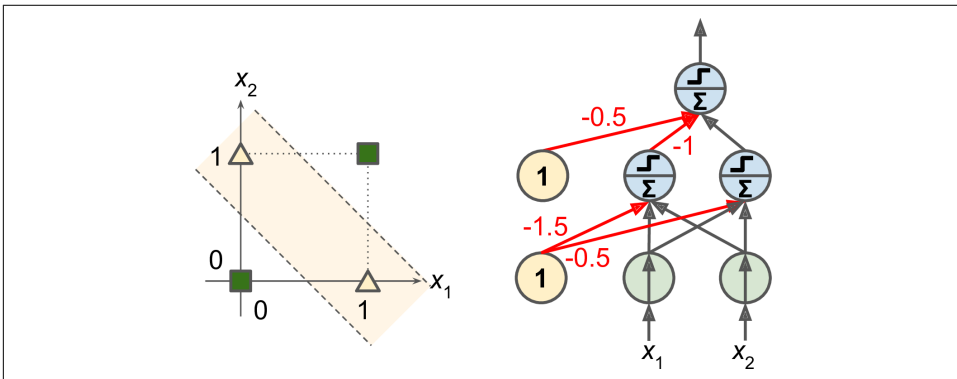

Figure 10-6. XOR classification problem and an MLP that solves it

Multi-Layer Perceptron and Backpropagation

An MLP is composed of one (passthrough) *input layer*, one or more layers of TLUs, called *hidden layers*, and one final layer of TLUs called the *output layer* (see [Figure 10-7](#)). The layers close to the input layer are usually called the lower layers, and the ones close to the outputs are usually called the upper layers. Every layer except the output layer includes a bias neuron and is fully connected to the next layer.

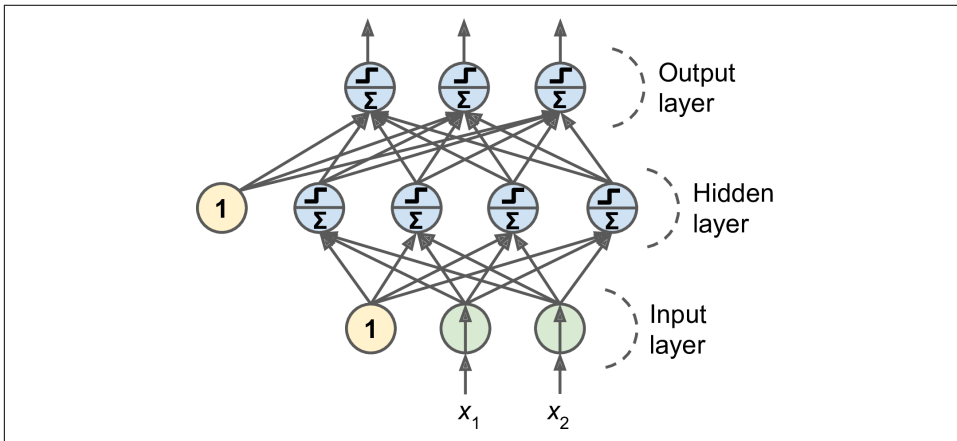

Figure 10-7. Multi-Layer Perceptron



The signal flows only in one direction (from the inputs to the outputs), so this architecture is an example of a *feedforward neural network* (FNN).

When an ANN contains a deep stack of hidden layers⁸, it is called a *deep neural network* (DNN). The field of Deep Learning studies DNNs, and more generally models containing deep stacks of computations. However, many people talk about Deep Learning whenever neural networks are involved (even shallow ones).

For many years researchers struggled to find a way to train MLPs, without success. But in 1986, David Rumelhart, Geoffrey Hinton and Ronald Williams published a [groundbreaking paper](#)⁹ introducing the *backpropagation* training algorithm, which is still used today. In short, it is simply Gradient Descent (introduced in [Chapter 4](#))

⁸ In the 1990s, an ANN with more than two hidden layers was considered deep. Nowadays, it is common to see ANNs with dozens of layers, or even hundreds, so the definition of “deep” is quite fuzzy.

⁹ “Learning Internal Representations by Error Propagation,” D. Rumelhart, G. Hinton, R. Williams (1986).

using an efficient technique for computing the gradients automatically¹⁰: in just two passes through the network (one forward, one backward), the backpropagation algorithm is able to compute the gradient of the network's error with regards to every single model parameter. In other words, it can find out how each connection weight and each bias term should be tweaked in order to reduce the error. Once it has these gradients, it just performs a regular Gradient Descent step, and the whole process is repeated until the network converges to the solution.



Automatically computing gradients is called *automatic differentiation*, or *autodiff*. There are various autodiff techniques, with different pros and cons. The one used by backpropagation is called *reverse-mode autodiff*. It is fast and precise, and is well suited when the function to differentiate has many variables (e.g., connection weights) and few outputs (e.g., one loss). If you want to learn more about autodiff, check out ???.

Let's run through this algorithm in a bit more detail:

- It handles one mini-batch at a time (for example containing 32 instances each), and it goes through the full training set multiple times. Each pass is called an *epoch*, as we saw in [Chapter 4](#).
- Each mini-batch is passed to the network's input layer, which just sends it to the first hidden layer. The algorithm then computes the output of all the neurons in this layer (for every instance in the mini-batch). The result is passed on to the next layer, its output is computed and passed to the next layer, and so on until we get the output of the last layer, the output layer. This is the *forward pass*: it is exactly like making predictions, except all intermediate results are preserved since they are needed for the backward pass.
- Next, the algorithm measures the network's output error (i.e., it uses a loss function that compares the desired output and the actual output of the network, and returns some measure of the error).
- Then it computes how much each output connection contributed to the error. This is done analytically by simply applying the *chain rule* (perhaps the most fundamental rule in calculus), which makes this step fast and precise.
- The algorithm then measures how much of these error contributions came from each connection in the layer below, again using the chain rule—and so on until the algorithm reaches the input layer. As we explained earlier, this reverse pass efficiently measures the error gradient across all the connection weights in the

¹⁰ This technique was actually independently invented several times by various researchers in different fields, starting with P. Werbos in 1974.

network by propagating the error gradient backward through the network (hence the name of the algorithm).

- Finally, the algorithm performs a Gradient Descent step to tweak all the connection weights in the network, using the error gradients it just computed.

This algorithm is so important, it's worth summarizing it again: for each training instance the backpropagation algorithm first makes a prediction (forward pass), measures the error, then goes through each layer in reverse to measure the error contribution from each connection (reverse pass), and finally slightly tweaks the connection weights to reduce the error (Gradient Descent step).



It is important to initialize all the hidden layers' connection weights randomly, or else training will fail. For example, if you initialize all weights and biases to zero, then all neurons in a given layer will be perfectly identical, and thus backpropagation will affect them in exactly the same way, so they will remain identical. In other words, despite having hundreds of neurons per layer, your model will act as if it had only one neuron per layer: it won't be too smart. If instead you randomly initialize the weights, you *break the symmetry* and allow backpropagation to train a diverse team of neurons.

In order for this algorithm to work properly, the authors made a key change to the MLP's architecture: they replaced the step function with the logistic function, $\sigma(z) = 1 / (1 + \exp(-z))$. This was essential because the step function contains only flat segments, so there is no gradient to work with (Gradient Descent cannot move on a flat surface), while the logistic function has a well-defined nonzero derivative everywhere, allowing Gradient Descent to make some progress at every step. In fact, the backpropagation algorithm works well with many other *activation functions*, not just the logistic function. Two other popular activation functions are:

The hyperbolic tangent function $\tanh(z) = 2\sigma(2z) - 1$

Just like the logistic function it is S-shaped, continuous, and differentiable, but its output value ranges from -1 to 1 (instead of 0 to 1 in the case of the logistic function), which tends to make each layer's output more or less centered around 0 at the beginning of training. This often helps speed up convergence.

The Rectified Linear Unit function: $\text{ReLU}(z) = \max(0, z)$

It is continuous but unfortunately not differentiable at $z = 0$ (the slope changes abruptly, which can make Gradient Descent bounce around), and its derivative is 0 for $z < 0$. However, in practice it works very well and has the advantage of being

fast to compute¹¹. Most importantly, the fact that it does not have a maximum output value also helps reduce some issues during Gradient Descent (we will come back to this in [Chapter 11](#)).

These popular activation functions and their derivatives are represented in [Figure 10-8](#). But wait! Why do we need activation functions in the first place? Well, if you chain several linear transformations, all you get is a linear transformation. For example, say $f(x) = 2x + 3$ and $g(x) = 5x - 1$, then chaining these two linear functions gives you another linear function: $f(g(x)) = 2(5x - 1) + 3 = 10x + 1$. So if you don't have some non-linearity between layers, then even a deep stack of layers is equivalent to a single layer: you cannot solve very complex problems with that.

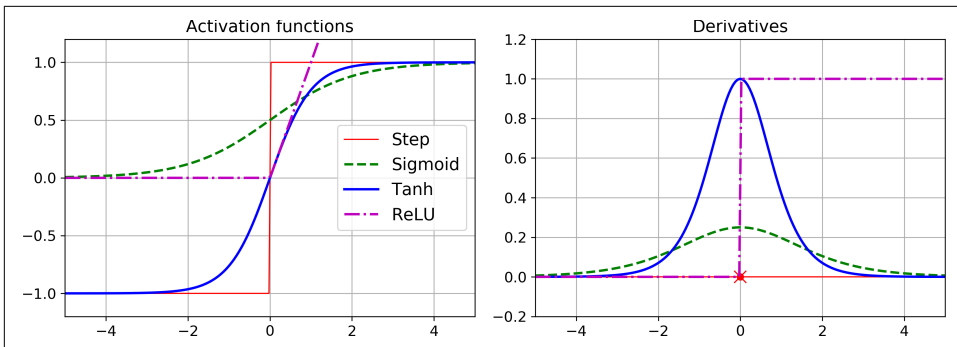

Figure 10-8. Activation functions and their derivatives

Okay! So now you know where neural nets came from, what their architecture is and how to compute their outputs, and you also learned about the backpropagation algorithm. But what exactly can you do with them?

Regression MLPs

First, MLPs can be used for regression tasks. If you want to predict a single value (e.g., the price of a house given many of its features), then you just need a single output neuron: its output is the predicted value. For multivariate regression (i.e., to predict multiple values at once), you need one output neuron per output dimension. For example, to locate the center of an object on an image, you need to predict 2D coordinates, so you need two output neurons. If you also want to place a bounding box around the object, then you need two more numbers: the width and the height of the object. So you end up with 4 output neurons.

¹¹ Biological neurons seem to implement a roughly sigmoid (S-shaped) activation function, so researchers stuck to sigmoid functions for a very long time. But it turns out that ReLU generally works better in ANNs. This is one of the cases where the biological analogy was misleading.

In general, when building an MLP for regression, you do not want to use any activation function for the output neurons, so they are free to output any range of values. However, if you want to guarantee that the output will always be positive, then you can use the ReLU activation function, or the *softplus* activation function in the output layer. Finally, if you want to guarantee that the predictions will fall within a given range of values, then you can use the logistic function or the hyperbolic tangent, and scale the labels to the appropriate range: 0 to 1 for the logistic function, or -1 to 1 for the hyperbolic tangent.

The loss function to use during training is typically the mean squared error, but if you have a lot of outliers in the training set, you may prefer to use the mean absolute error instead. Alternatively, you can use the Huber loss, which is a combination of both.



The Huber loss is quadratic when the error is smaller than a threshold δ (typically 1), but linear when the error is larger than δ . This makes it less sensitive to outliers than the mean squared error, and it is often more precise and converges faster than the mean absolute error.

Table 10-1 summarizes the typical architecture of a regression MLP.

Table 10-1. Typical Regression MLP Architecture

Hyperparameter	Typical Value
# input neurons	One per input feature (e.g., $28 \times 28 = 784$ for MNIST)
# hidden layers	Depends on the problem. Typically 1 to 5.
# neurons per hidden layer	Depends on the problem. Typically 10 to 100.
# output neurons	1 per prediction dimension
Hidden activation	ReLU (or SELU, see Chapter 11)
Output activation	None or ReLU/Softplus (if positive outputs) or Logistic/Tanh (if bounded outputs)
Loss function	MSE or MAE/Huber (if outliers)

Classification MLPs

MLPs can also be used for classification tasks. For a binary classification problem, you just need a single output neuron using the logistic activation function: the output will be a number between 0 and 1, which you can interpret as the estimated probability of the positive class. Obviously, the estimated probability of the negative class is equal to one minus that number.

MLPs can also easily handle multilabel binary classification tasks (see [Chapter 3](#)). For example, you could have an email classification system that predicts whether each incoming email is ham or spam, and simultaneously predicts whether it is an urgent

or non-urgent email. In this case, you would need two output neurons, both using the logistic activation function: the first would output the probability that the email is spam and the second would output the probability that it is urgent. More generally, you would dedicate one output neuron for each positive class. Note that the output probabilities do not necessarily add up to one. This lets the model output any combination of labels: you can have non-urgent ham, urgent ham, non-urgent spam, and perhaps even urgent spam (although that would probably be an error).

If each instance can belong only to a single class, out of 3 or more possible classes (e.g., classes 0 through 9 for digit image classification), then you need to have one output neuron per class, and you should use the *softmax* activation function for the whole output layer (see [Figure 10-9](#)). The softmax function (introduced in [Chapter 4](#)) will ensure that all the estimated probabilities are between 0 and 1 and that they add up to one (which is required if the classes are exclusive). This is called multiclass classification.

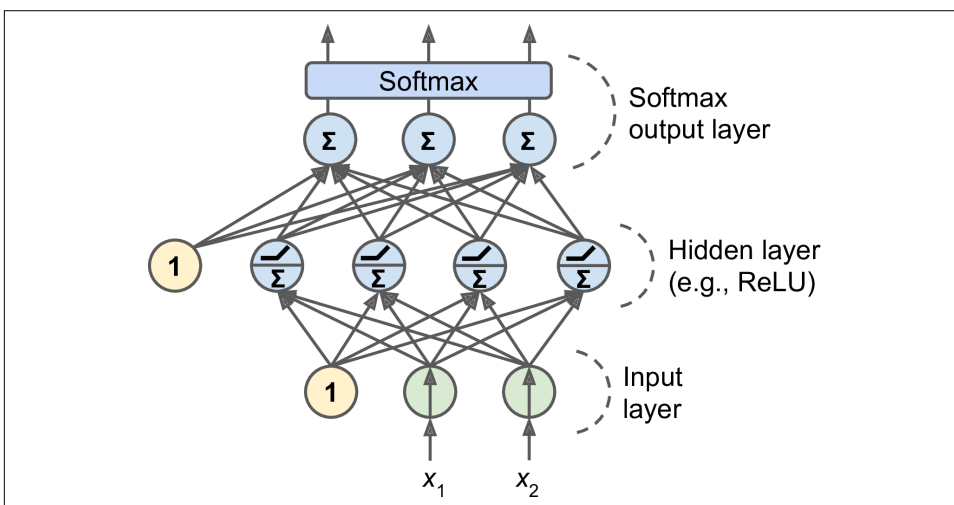

Figure 10-9. A modern MLP (including ReLU and softmax) for classification

Regarding the loss function, since we are predicting probability distributions, the cross-entropy (also called the log loss, see [Chapter 4](#)) is generally a good choice.

[Table 10-2](#) summarizes the typical architecture of a classification MLP.

Table 10-2. Typical Classification MLP Architecture

Hyperparameter	Binary classification	Multilabel binary classification	Multiclass classification
Input and hidden layers	Same as regression	Same as regression	Same as regression
# output neurons	1	1 per label	1 per class
Output layer activation	Logistic	Logistic	Softmax

Hyperparameter	Binary classification	Multilabel binary classification	Multiclass classification
Loss function	Cross-Entropy	Cross-Entropy	Cross-Entropy



Before we go on, I recommend you go through exercise 1, at the end of this chapter. You will play with various neural network architectures and visualize their outputs using the *TensorFlow Playground*. This will be very useful to better understand MLPs, for example the effects of all the hyperparameters (number of layers and neurons, activation functions, and more).

Now you have all the concepts you need to start implementing MLPs with Keras!

Implementing MLPs with Keras

Keras is a high-level Deep Learning API that allows you to easily build, train, evaluate and execute all sorts of neural networks. Its documentation (or specification) is available at <https://keras.io>. The reference implementation is simply called Keras as well, so to avoid any confusion we will call it `keras-team` (since it is available at <https://github.com/keras-team/keras>). It was developed by François Chollet as part of a research project¹² and released as an open source project in March 2015. It quickly gained popularity owing to its ease-of-use, flexibility and beautiful design. To perform the heavy computations required by neural networks, `keras-team` relies on a computation backend. At the present, you can choose from three popular open source deep learning libraries: TensorFlow, Microsoft Cognitive Toolkit (CNTK) or Theano.

Moreover, since late 2016, other implementations have been released. You can now run Keras on Apache MXNet, Apple's Core ML, Javascript or Typescript (to run Keras code in a web browser), or PlaidML (which can run on all sorts of GPU devices, not just Nvidia). Moreover, TensorFlow itself now comes bundled with its own Keras implementation called `tf.keras`. It only supports TensorFlow as the backend, but it has the advantage of offering some very useful extra features (see [Figure 10-10](#)): for example, it supports TensorFlow's Data API which makes it quite easy to load and preprocess data efficiently. For this reason, we will use `tf.keras` in this book. However, in this chapter we will not use any of the TensorFlow-specific features, so the code should run fine on other Keras implementations as well (at least in Python), with only minor modifications, such as changing the imports.

¹² Project ONEIROS (Open-ended Neuro-Electronic Intelligent Robot Operating System).

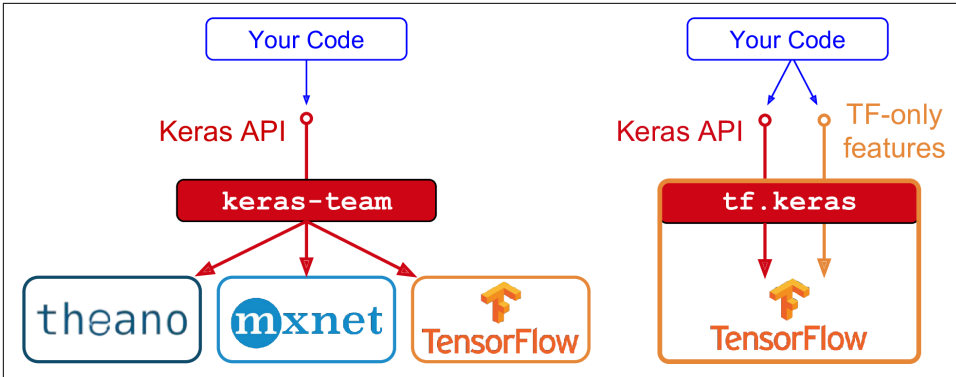

Figure 10-10. Two Keras implementations: *keras-team* (left) and *tf.keras* (right)

As *tf.keras* is bundled with TensorFlow, let's install TensorFlow!

Installing TensorFlow 2

Assuming you installed Jupyter and Scikit-Learn by following the installation instructions in [Chapter 2](#), you can simply use `pip` to install TensorFlow. If you created an isolated environment using `virtualenv`, you first need to activate it:

```
$ cd $ML_PATH           # Your ML working directory (e.g., $HOME/ml)
$ source env/bin/activate # on Linux or MacOSX
$ .\env\Scripts\activate # on Windows
```

Next, install TensorFlow 2 (if you are not using a `virtualenv`, you will need administrator rights, or to add the `--user` option):

```
$ python3 -m pip install --upgrade tensorflow
```



For GPU support, you need to install `tensorflow-gpu` instead of `tensorflow`, and there are other libraries to install. See <https://tensorflow.org/install/gpu> for more details.

To test your installation, open a Python shell or a Jupyter notebook, then import TensorFlow and *tf.keras*, and print their versions:

```
>>> import tensorflow as tf
>>> from tensorflow import keras
>>> tf.__version__
'2.0.0'
>>> keras.__version__
'2.2.4-tf'
```

The second version is the version of the Keras API implemented by `tf.keras`. Note that it ends with `-tf`, highlighting the fact that `tf.keras` implements the Keras API, plus some extra TensorFlow-specific features.

Now let's use `tf.keras`! Let's start by building a simple image classifier.

Building an Image Classifier Using the Sequential API

First, we need to load a dataset. We will tackle *Fashion MNIST*, which is a drop-in replacement of MNIST (introduced in [Chapter 3](#)). It has the exact same format as MNIST (70,000 grayscale images of 28×28 pixels each, with 10 classes), but the images represent fashion items rather than handwritten digits, so each class is more diverse and the problem turns out to be significantly more challenging than MNIST. For example, a simple linear model reaches about 92% accuracy on MNIST, but only about 83% on Fashion MNIST.

Using Keras to Load the Dataset

Keras provides some utility functions to fetch and load common datasets, including MNIST, Fashion MNIST, the original California housing dataset, and more. Let's load Fashion MNIST:

```
fashion_mnist = keras.datasets.fashion_mnist
(X_train_full, y_train_full), (X_test, y_test) = fashion_mnist.load_data()
```

When loading MNIST or Fashion MNIST using Keras rather than Scikit-Learn, one important difference is that every image is represented as a 28×28 array rather than a 1D array of size 784. Moreover, the pixel intensities are represented as integers (from 0 to 255) rather than floats (from 0.0 to 255.0). Here is the shape and data type of the training set:

```
>>> X_train_full.shape
(60000, 28, 28)
>>> X_train_full.dtype
dtype('uint8')
```

Note that the dataset is already split into a training set and a test set, but there is no validation set, so let's create one. Moreover, since we are going to train the neural network using Gradient Descent, we must scale the input features. For simplicity, we just scale the pixel intensities down to the 0-1 range by dividing them by 255.0 (this also converts them to floats):

```
X_valid, X_train = X_train_full[:5000] / 255.0, X_train_full[5000:] / 255.0
y_valid, y_train = y_train_full[:5000], y_train_full[5000:]
```

With MNIST, when the label is equal to 5, it means that the image represents the handwritten digit 5. Easy. However, for Fashion MNIST, we need the list of class names to know what we are dealing with:

```
class_names = ["T-shirt/top", "Trouser", "Pullover", "Dress", "Coat",
               "Sandal", "Shirt", "Sneaker", "Bag", "Ankle boot"]
```

For example, the first image in the training set represents a coat:

```
>>> class_names[y_train[0]]
'Coat'
```

Figure 10-11 shows a few samples from the Fashion MNIST dataset:



Figure 10-11. Samples from Fashion MNIST

Creating the Model Using the Sequential API

Now let's build the neural network! Here is a classification MLP with two hidden layers:

```
model = keras.models.Sequential()
model.add(keras.layers.Flatten(input_shape=[28, 28]))
model.add(keras.layers.Dense(300, activation="relu"))
model.add(keras.layers.Dense(100, activation="relu"))
model.add(keras.layers.Dense(10, activation="softmax"))
```

Let's go through this code line by line:

- The first line creates a `Sequential` model. This is the simplest kind of Keras model, for neural networks that are just composed of a single stack of layers, connected sequentially. This is called the sequential API.
- Next, we build the first layer and add it to the model. It is a `Flatten` layer whose role is simply to convert each input image into a 1D array: if it receives input data X , it computes $X.reshape(-1, 1)$. This layer does not have any parameters, it is just there to do some simple preprocessing. Since it is the first layer in the model, you should specify the `input_shape`: this does not include the batch size, only the shape of the instances. Alternatively, you could add a `keras.layers.InputLayer` as the first layer, setting `shape=[28,28]`.
- Next we add a `Dense` hidden layer with 300 neurons. It will use the ReLU activation function. Each `Dense` layer manages its own weight matrix, containing all the connection weights between the neurons and their inputs. It also manages a vec-

tor of bias terms (one per neuron). When it receives some input data, it computes [Equation 10-2](#).

- Next we add a second Dense hidden layer with 100 neurons, also using the ReLU activation function.
- Finally, we add a Dense output layer with 10 neurons (one per class), using the softmax activation function (because the classes are exclusive).



Specifying `activation="relu"` is equivalent to `activation=keras.activations.relu`. Other activation functions are available in the `keras.activations` package, we will use many of them in this book. See <https://keras.io/activations/> for the full list.

Instead of adding the layers one by one as we just did, you can pass a list of layers when creating the `Sequential` model:

```
model = keras.models.Sequential([
    keras.layers.Flatten(input_shape=[28, 28]),
    keras.layers.Dense(300, activation="relu"),
    keras.layers.Dense(100, activation="relu"),
    keras.layers.Dense(10, activation="softmax")
])
```

Using Code Examples From `keras.io`

Code examples documented on `keras.io` will work fine with `tf.keras`, but you need to change the imports. For example, consider this `keras.io` code:

```
from keras.layers import Dense
output_layer = Dense(10)
```

You must change the imports like this:

```
from tensorflow.keras.layers import Dense
output_layer = Dense(10)
```

Or simply use full paths, if you prefer:

```
from tensorflow import keras
output_layer = keras.layers.Dense(10)
```

This is more verbose, but I use this approach in this book so you can easily see which packages to use, and to avoid confusion between standard classes and custom classes. In production code, I use the previous approach, as do most people.

The model's `summary()` method displays all the model's layers¹³, including each layer's name (which is automatically generated unless you set it when creating the layer), its output shape (None means the batch size can be anything), and its number of parameters. The summary ends with the total number of parameters, including trainable and non-trainable parameters. Here we only have trainable parameters (we will see examples of non-trainable parameters in [Chapter 11](#)):

```
>>> model.summary()
```

Layer (type)	Output Shape	Param #
flatten_1 (Flatten)	(None, 784)	0
dense_3 (Dense)	(None, 300)	235500
dense_4 (Dense)	(None, 100)	30100
dense_5 (Dense)	(None, 10)	1010

=====
Total params: 266,610
Trainable params: 266,610
Non-trainable params: 0

Note that Dense layers often have a *lot* of parameters. For example, the first hidden layer has 784×300 connection weights, plus 300 bias terms, which adds up to 235,500 parameters! This gives the model quite a lot of flexibility to fit the training data, but it also means that the model runs the risk of overfitting, especially when you do not have a lot of training data. We will come back to this later.

You can easily get a model's list of layers, to fetch a layer by its index, or you can fetch it by name:

```
>>> model.layers
[<tensorflow.python.keras.layers.core.Flatten at 0x132414e48>,
 <tensorflow.python.keras.layers.core.Dense at 0x1324149b0>,
 <tensorflow.python.keras.layers.core.Dense at 0x1356ba8d0>,
 <tensorflow.python.keras.layers.core.Dense at 0x13240d240>]
>>> model.layers[1].name
'dense_3'
>>> model.get_layer('dense_3').name
'dense_3'
```

All the parameters of a layer can be accessed using its `get_weights()` and `set_weights()` method. For a Dense layer, this includes both the connection weights and the bias terms:

¹³ You can also generate an image of your model using `keras.utils.plot_model()`.

```

>>> weights, biases = hidden1.get_weights()
>>> weights
array([[ 0.03854964, -0.04054524,  0.00599282, ...,  0.02566582,
         0.01032123,  0.06914985],
       ...,
       [ 0.02632413, -0.05105981, -0.00332005, ...,  0.04175945,
         0.0443138 , -0.05558084]], dtype=float32)
>>> weights.shape
(784, 300)
>>> biases
array([0., 0., 0., 0., 0., 0., 0., 0., 0., ..., 0., 0., 0.], dtype=float32)
>>> biases.shape
(300,)

```

Notice that the Dense layer initialized the connection weights randomly (which is needed to break symmetry, as we discussed earlier), and the biases were just initialized to zeros, which is fine. If you ever want to use a different initialization method, you can set `kernel_initializer` (*kernel* is another name for the matrix of connection weights) or `bias_initializer` when creating the layer. We will discuss initializers further in [Chapter 11](#), but if you want the full list, see <https://keras.io/initializers/>.



The shape of the weight matrix depends on the number of inputs. This is why it is recommended to specify the `input_shape` when creating the first layer in a `Sequential` model. However, if you do not specify the input shape, it's okay: Keras will simply wait until it knows the input shape before it actually builds the model. This will happen either when you feed it actual data (e.g., during training), or when you call its `build()` method. Until the model is really built, the layers will not have any weights, and you will not be able to do certain things (such as print the model summary or save the model), so if you know the input shape when creating the model, it is best to specify it.

Compiling the Model

After a model is created, you must call its `compile()` method to specify the loss function and the optimizer to use. Optionally, you can also specify a list of extra metrics to compute during training and evaluation:

```

model.compile(loss="sparse_categorical_crossentropy",
              optimizer="sgd",
              metrics=["accuracy"])

```



Using `loss="sparse_categorical_crossentropy"` is equivalent to `loss=keras.losses.sparse_categorical_crossentropy`. Similarly, `optimizer="sgd"` is equivalent to `optimizer=keras.optimizers.SGD()` and `metrics=["accuracy"]` is equivalent to `metrics=[keras.metrics.sparse_categorical_accuracy]` (when using this loss). We will use many other losses, optimizers and metrics in this book, but for the full lists see <https://keras.io/losses/>, <https://keras.io/optimizers/> and <https://keras.io/metrics/>.

This requires some explanation. First, we use the "sparse_categorical_crossentropy" loss because we have sparse labels (i.e., for each instance there is just a target class index, from 0 to 9 in this case), and the classes are exclusive. If instead we had one target probability per class for each instance (such as one-hot vectors, e.g. [0., 0., 0., 1., 0., 0., 0., 0., 0., 0.] to represent class 3), then we would need to use the "categorical_crossentropy" loss instead. If we were doing binary classification (with one or more binary labels), then we would use the "sigmoid" (i.e., logistic) activation function in the output layer instead of the "softmax" activation function, and we would use the "binary_crossentropy" loss.



If you want to convert sparse labels (i.e., class indices) to one-hot vector labels, you can use the `keras.utils.to_categorical()` function. To go the other way round, you can just use the `np.argmax()` function with `axis=1`.

Secondly, regarding the optimizer, "sgd" simply means that we will train the model using simple Stochastic Gradient Descent. In other words, Keras will perform the backpropagation algorithm described earlier (i.e., reverse-mode autodiff + Gradient Descent). We will discuss more efficient optimizers in **Chapter 11** (they improve the Gradient Descent part, not the autodiff).

Finally, since this is a classifier, it's useful to measure its "accuracy" during training and evaluation.

Training and Evaluating the Model

Now the model is ready to be trained. For this we simply need to call its `fit()` method. We pass it the input features (`X_train`) and the target classes (`y_train`), as well as the number of epochs to train (or else it would default to just 1, which would definitely not be enough to converge to a good solution). We also pass a validation set (this is optional): Keras will measure the loss and the extra metrics on this set at the end of each epoch, which is very useful to see how well the model really performs: if the performance on the training set is much better than on the validation set, your

model is probably overfitting the training set (or there is a bug, such as a data mismatch between the training set and the validation set):

```
>>> history = model.fit(X_train, y_train, epochs=30,
...                     validation_data=(X_valid, y_valid))
...
Train on 55000 samples, validate on 5000 samples
Epoch 1/30
55000/55000 [=====] - 3s 55us/sample - loss: 1.4948      - acc: 0.5757
                                     - val_loss: 1.0042 - val_acc: 0.7166

Epoch 2/30
55000/55000 [=====] - 3s 55us/sample - loss: 0.8690      - acc: 0.7318
                                     - val_loss: 0.7549 - val_acc: 0.7616

[...]
Epoch 50/50
55000/55000 [=====] - 4s 72us/sample - loss: 0.3607      - acc: 0.8752
                                     - val_loss: 0.3706 - val_acc: 0.8728
```

And that's it! The neural network is trained. At each epoch during training, Keras displays the number of instances processed so far (along with a progress bar), the mean training time per sample, the loss and accuracy (or any other extra metrics you asked for), both on the training set and the validation set. You can see that the training loss went down, which is a good sign, and the validation accuracy reached 87.28% after 50 epochs, not too far from the training accuracy, so there does not seem to be much overfitting going on.



Instead of passing a validation set using the `validation_data` argument, you could instead set `validation_split` to the ratio of the training set that you want Keras to use for validation (e.g., 0.1).

If the training set was very skewed, with some classes being overrepresented and others underrepresented, it would be useful to set the `class_weight` argument when calling the `fit()` method, giving a larger weight to underrepresented classes, and a lower weight to overrepresented classes. These weights would be used by Keras when computing the loss. If you need per-instance weights instead, you can set the `sample_weight` argument (it supersedes `class_weight`). This could be useful for example if some instances were labeled by experts while others were labeled using a crowdsourcing platform: you might want to give more weight to the former. You can also provide sample weights (but not class weights) for the validation set by adding them as a third item in the `validation_data` tuple.

The `fit()` method returns a `History` object containing the training parameters (`history.params`), the list of epochs it went through (`history.epoch`), and most importantly a dictionary (`history.history`) containing the loss and extra metrics it measured at the end of each epoch on the training set and on the validation set (if

any). If you create a Pandas DataFrame using this dictionary and call its `plot()` method, you get the learning curves shown in [Figure 10-12](#):

```
import pandas as pd

pd.DataFrame(history.history).plot(figsize=(8, 5))
plt.grid(True)
plt.gca().set_ylim(0, 1) # set the vertical range to [0-1]
plt.show()
```

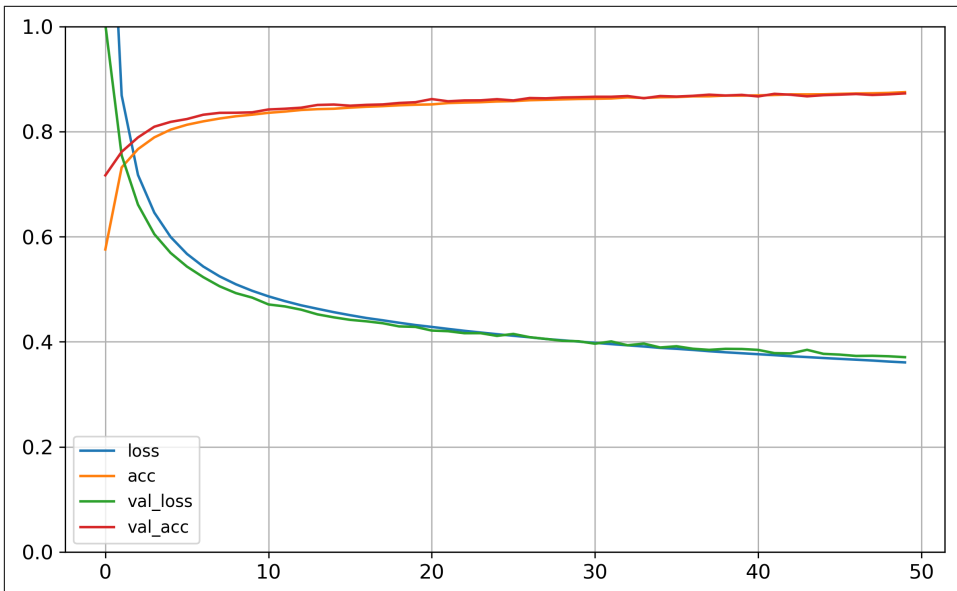

Figure 10-12. Learning Curves

You can see that both the training and validation accuracy steadily increase during training, while the training and validation loss decrease. Good! Moreover, the validation curves are quite close to the training curves, which means that there is not too much overfitting. In this particular case, the model performed better on the validation set than on the training set at the beginning of training: this sometimes happens by chance (especially when the validation set is fairly small). However, the training set performance ends up beating the validation performance, as is generally the case when you train for long enough. You can tell that the model has not quite converged yet, as the validation loss is still going down, so you should probably continue training. It's as simple as calling the `fit()` method again, since Keras just continues training where it left off (you should be able to reach close to 89% validation accuracy).

If you are not satisfied with the performance of your model, you should go back and tune the model's hyperparameters, for example the number of layers, the number of neurons per layer, the types of activation functions we use for each hidden layer, the

number of training epochs, the batch size (it can be set in the `fit()` method using the `batch_size` argument, which defaults to 32). We will get back to hyperparameter tuning at the end of this chapter. Once you are satisfied with your model's validation accuracy, you should evaluate it on the test set to estimate the generalization error before you deploy the model to production. You can easily do this using the `evaluate()` method (it also supports several other arguments, such as `batch_size` or `sample_weight`, please check the documentation for more details):

```
>>> model.evaluate(X_test, y_test)
8832/10000 [=====] - ETA: 0s - loss: 0.4074 - acc: 0.8540
[0.40738476498126985, 0.854]
```

As we saw in [Chapter 2](#), it is common to get slightly lower performance on the test set than on the validation set, because the hyperparameters are tuned on the validation set, not the test set (however, in this example, we did not do any hyperparameter tuning, so the lower accuracy is just bad luck). Remember to resist the temptation to tweak the hyperparameters on the test set, or else your estimate of the generalization error will be too optimistic.

Using the Model to Make Predictions

Next, we can use the model's `predict()` method to make predictions on new instances. Since we don't have actual new instances, we will just use the first 3 instances of the test set:

```
>>> X_new = X_test[:3]
>>> y_proba = model.predict(X_new)
>>> y_proba.round(2)
array([[0. , 0. , 0. , 0. , 0. , 0.09, 0. , 0.12, 0. , 0.79],
       [0. , 0. , 0.94, 0. , 0.02, 0. , 0.04, 0. , 0. , 0. ],
       [0. , 1. , 0. , 0. , 0. , 0. , 0. , 0. , 0. , 0. ]],
      dtype=float32)
```

As you can see, for each instance the model estimates one probability per class, from class 0 to class 9. For example, for the first image it estimates that the probability of class 9 (ankle boot) is 79%, the probability of class 7 (sneaker) is 12%, the probability of class 5 (sandal) is 9%, and the other classes are negligible. In other words, it “believes” it's footwear, probably ankle boots, but it's not entirely sure, it might be sneakers or sandals instead. If you only care about the class with the highest estimated probability (even if that probability is quite low) then you can use the `predict_classes()` method instead:

```
>>> y_pred = model.predict_classes(X_new)
>>> y_pred
array([9, 2, 1])
>>> np.array(class_names)[y_pred]
array(['Ankle boot', 'Pullover', 'Trouser'], dtype='<U11')
```

And the classifier actually classified all three images correctly:

```
>>> y_new = y_test[:3]
>>> y_new
array([9, 2, 1])
```

Now you know how to build, train, evaluate and use a classification MLP using the Sequential API. But what about regression?

Building a Regression MLP Using the Sequential API

Let's switch to the California housing problem and tackle it using a regression neural network. For simplicity, we will use Scikit-Learn's `fetch_california_housing()` function to load the data: this dataset is simpler than the one we used in [Chapter 2](#), since it contains only numerical features (there is no `ocean_proximity` feature), and there is no missing value. After loading the data, we split it into a training set, a validation set and a test set, and we scale all the features:

```
from sklearn.datasets import fetch_california_housing
from sklearn.model_selection import train_test_split
from sklearn.preprocessing import StandardScaler

housing = fetch_california_housing()

X_train_full, X_test, y_train_full, y_test = train_test_split(
    housing.data, housing.target)
X_train, X_valid, y_train, y_valid = train_test_split(
    X_train_full, y_train_full)

scaler = StandardScaler()
X_train_scaled = scaler.fit_transform(X_train)
X_valid_scaled = scaler.transform(X_valid)
X_test_scaled = scaler.transform(X_test)
```

Building, training, evaluating and using a regression MLP using the Sequential API to make predictions is quite similar to what we did for classification. The main differences are the fact that the output layer has a single neuron (since we only want to predict a single value) and uses no activation function, and the loss function is the mean squared error. Since the dataset is quite noisy, we just use a single hidden layer with fewer neurons than before, to avoid overfitting:

```
model = keras.models.Sequential([
    keras.layers.Dense(30, activation="relu", input_shape=X_train.shape[1:]),
    keras.layers.Dense(1)
])
model.compile(loss="mean_squared_error", optimizer="sgd")
history = model.fit(X_train, y_train, epochs=20,
                    validation_data=(X_valid, y_valid))
mse_test = model.evaluate(X_test, y_test)
X_new = X_test[:3] # pretend these are new instances
y_pred = model.predict(X_new)
```

As you can see, the Sequential API is quite easy to use. However, although sequential models are extremely common, it is sometimes useful to build neural networks with more complex topologies, or with multiple inputs or outputs. For this purpose, Keras offers the Functional API.

Building Complex Models Using the Functional API

One example of a non-sequential neural network is a *Wide & Deep* neural network. This neural network architecture was introduced in a [2016 paper](#) by Heng-Tze Cheng et al.¹⁴. It connects all or part of the inputs directly to the output layer, as shown in [Figure 10-13](#). This architecture makes it possible for the neural network to learn both deep patterns (using the deep path) and simple rules (through the short path). In contrast, a regular MLP forces all the data to flow through the full stack of layers, thus simple patterns in the data may end up being distorted by this sequence of transformations.

¹⁴ “Wide & Deep Learning for Recommender Systems,” Heng-Tze Cheng et al. (2016).

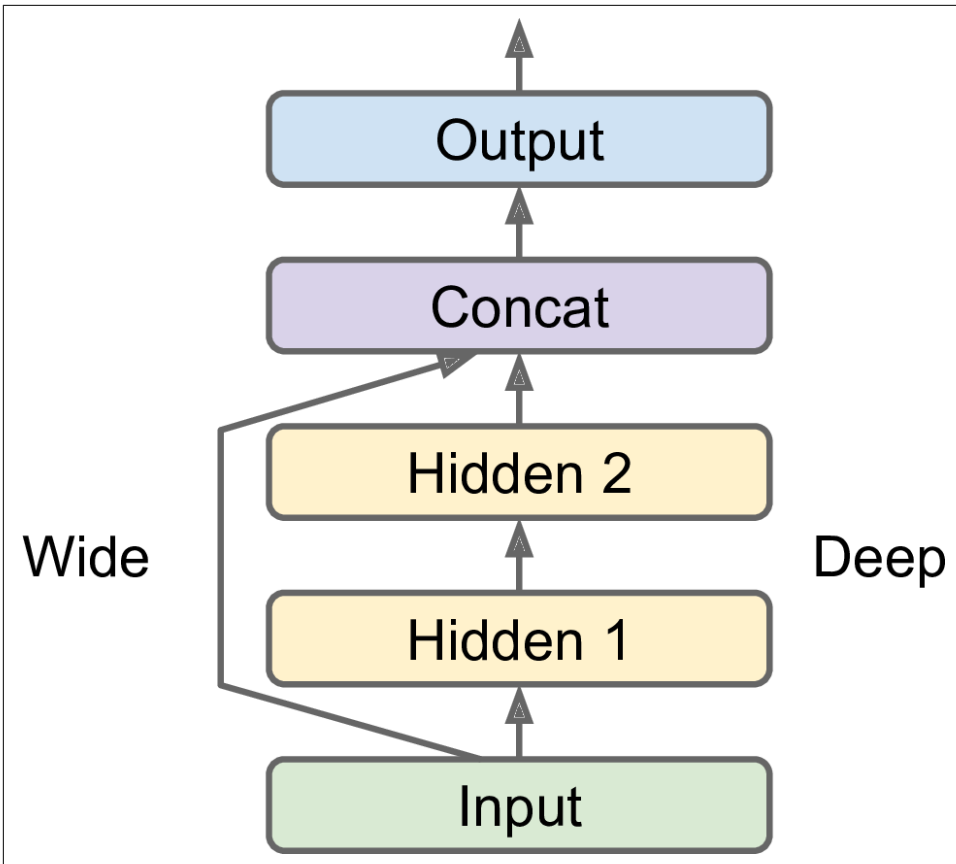

Figure 10-13. Wide and Deep Neural Network

Let's build such a neural network to tackle the California housing problem:

```
input = keras.layers.Input(shape=X_train.shape[1:])
hidden1 = keras.layers.Dense(30, activation="relu")(input)
hidden2 = keras.layers.Dense(30, activation="relu")(hidden1)
concat = keras.layers.Concatenate()[input, hidden2]
output = keras.layers.Dense(1)(concat)
model = keras.models.Model(inputs=[input], outputs=[output])
```

Let's go through each line of this code:

- First, we need to create an Input object. This is needed because we may have multiple inputs, as we will see later.
- Next, we create a Dense layer with 30 neurons and using the ReLU activation function. As soon as it is created, notice that we call it like a function, passing it the input. This is why this is called the Functional API. Note that we are just tell-

ing Keras how it should connect the layers together, no actual data is being processed yet.

- We then create a second hidden layer, and again we use it as a function. Note however that we pass it the output of the first hidden layer.
- Next, we create a `Concatenate()` layer, and once again we immediately use it like a function, to concatenate the input and the output of the second hidden layer (you may prefer the `keras.layers.concatenate()` function, which creates a `Concatenate` layer and immediately calls it with the given inputs).
- Then we create the output layer, with a single neuron and no activation function, and we call it like a function, passing it the result of the concatenation.
- Lastly, we create a `Keras Model`, specifying which inputs and outputs to use.

Once you have built the Keras model, everything is exactly like earlier, so no need to repeat it here: you must compile the model, train it, evaluate it and use it to make predictions.

But what if you want to send a subset of the features through the wide path, and a different subset (possibly overlapping) through the deep path (see [Figure 10-14](#))? In this case, one solution is to use multiple inputs. For example, suppose we want to send 5 features through the deep path (features 0 to 4), and 6 features through the wide path (features 2 to 7):

```
input_A = keras.layers.Input(shape=[5])
input_B = keras.layers.Input(shape=[6])
hidden1 = keras.layers.Dense(30, activation="relu")(input_B)
hidden2 = keras.layers.Dense(30, activation="relu")(hidden1)
concat = keras.layers.concatenate([input_A, hidden2])
output = keras.layers.Dense(1)(concat)
model = keras.models.Model(inputs=[input_A, input_B], outputs=[output])
```

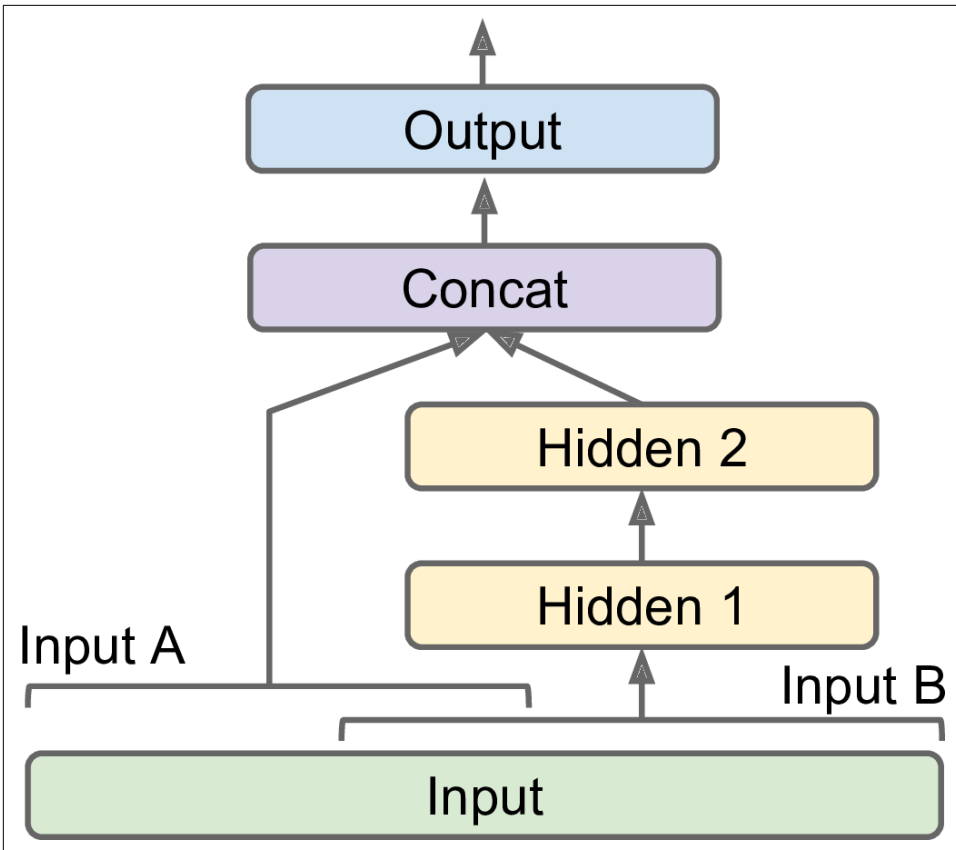

Figure 10-14. Handling Multiple Inputs

The code is self-explanatory. Note that we specified `inputs=[input_A, input_B]` when creating the model. Now we can compile the model as usual, but when we call the `fit()` method, instead of passing a single input matrix `X_train`, we must pass a pair of matrices (`X_train_A`, `X_train_B`): one per input. The same is true for `X_valid`, and also for `X_test` and `X_new` when you call `evaluate()` or `predict()`:

```

model.compile(loss="mse", optimizer="sgd")

X_train_A, X_train_B = X_train[:, :5], X_train[:, 2:]
X_valid_A, X_valid_B = X_valid[:, :5], X_valid[:, 2:]
X_test_A, X_test_B = X_test[:, :5], X_test[:, 2:]
X_new_A, X_new_B = X_test_A[:3], X_test_B[:3]

history = model.fit((X_train_A, X_train_B), y_train, epochs=20,
                    validation_data=((X_valid_A, X_valid_B), y_valid))
mse_test = model.evaluate((X_test_A, X_test_B), y_test)
y_pred = model.predict((X_new_A, X_new_B))

```

There are also many use cases in which you may want to have multiple outputs:

- The task may demand it, for example you may want to locate and classify the main object in a picture. This is both a regression task (finding the coordinates of the object's center, as well as its width and height) and a classification task.
- Similarly, you may have multiple independent tasks to perform based on the same data. Sure, you could train one neural network per task, but in many cases you will get better results on all tasks by training a single neural network with one output per task. This is because the neural network can learn features in the data that are useful across tasks.
- Another use case is as a regularization technique (i.e., a training constraint whose objective is to reduce overfitting and thus improve the model's ability to generalize). For example, you may want to add some auxiliary outputs in a neural network architecture (see [Figure 10-15](#)) to ensure that the underlying part of the network learns something useful on its own, without relying on the rest of the network.

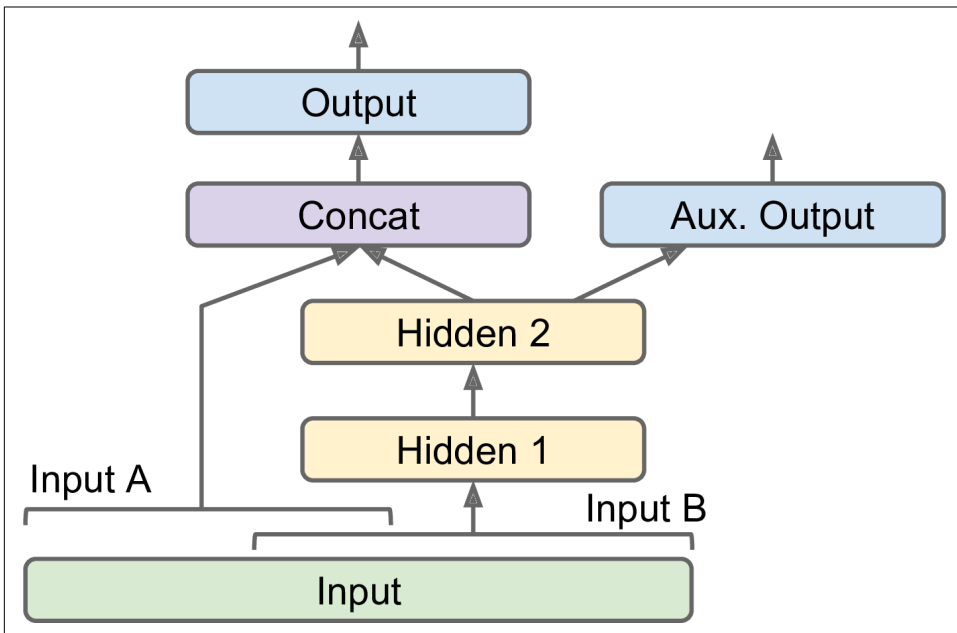

Figure 10-15. Handling Multiple Outputs – Auxiliary Output for Regularization

Adding extra outputs is quite easy: just connect them to the appropriate layers and add them to your model's list of outputs. For example, the following code builds the network represented in [Figure 10-15](#):

```
[...] # Same as above, up to the main output layer
output = keras.layers.Dense(1)(concat)
aux_output = keras.layers.Dense(1)(hidden2)
model = keras.models.Model(inputs=[input_A, input_B],
                           outputs=[output, aux_output])
```

Each output will need its own loss function, so when we compile the model we should pass a list of losses (if we pass a single loss, Keras will assume that the same loss must be used for all outputs). By default, Keras will compute all these losses and simply add them up to get the final loss used for training. However, we care much more about the main output than about the auxiliary output (as it is just used for regularization), so we want to give the main output's loss a much greater weight. Fortunately, it is possible to set all the loss weights when compiling the model:

```
model.compile(loss=["mse", "mse"], loss_weights=[0.9, 0.1], optimizer="sgd")
```

Now when we train the model, we need to provide some labels for each output. In this example, the main output and the auxiliary output should try to predict the same thing, so they should use the same labels. So instead of passing `y_train`, we just need to pass `(y_train, y_train)` (and the same goes for `y_valid` and `y_test`):

```
history = model.fit(
    [X_train_A, X_train_B], [y_train, y_train], epochs=20,
    validation_data=(X_valid_A, X_valid_B), [y_valid, y_valid])
```

When we evaluate the model, Keras will return the total loss, as well as all the individual losses:

```
total_loss, main_loss, aux_loss = model.evaluate(
    [X_test_A, X_test_B], [y_test, y_test])
```

Similarly, the `predict()` method will return predictions for each output:

```
y_pred_main, y_pred_aux = model.predict([X_new_A, X_new_B])
```

As you can see, you can build any sort of architecture you want quite easily with the Functional API. Let's look at one last way you can build Keras models.

Building Dynamic Models Using the Subclassing API

Both the Sequential API and the Functional API are declarative: you start by declaring which layers you want to use and how they should be connected, and only then can you start feeding the model some data for training or inference. This has many advantages: the model can easily be saved, cloned, shared, its structure can be displayed and analyzed, the framework can infer shapes and check types, so errors can be caught early (i.e., before any data ever goes through the model). It's also fairly easy to debug, since the whole model is just a static graph of layers. But the flip side is just that: it's static. Some models involve loops, varying shapes, conditional branching, and other dynamic behaviors. For such cases, or simply if you prefer a more imperative programming style, the Subclassing API is for you.

Simply subclass the `Model` class, create the layers you need in the constructor, and use them to perform the computations you want in the `call()` method. For example, creating an instance of the following `WideAndDeepModel` class gives us an equivalent model to the one we just built with the Functional API. You can then compile it, evaluate it and use it to make predictions, exactly like we just did.

```
class WideAndDeepModel(keras.models.Model):
    def __init__(self, units=30, activation="relu", **kwargs):
        super().__init__(**kwargs) # handles standard args (e.g., name)
        self.hidden1 = keras.layers.Dense(units, activation=activation)
        self.hidden2 = keras.layers.Dense(units, activation=activation)
        self.main_output = keras.layers.Dense(1)
        self.aux_output = keras.layers.Dense(1)

    def call(self, inputs):
        input_A, input_B = inputs
        hidden1 = self.hidden1(input_B)
        hidden2 = self.hidden2(hidden1)
        concat = keras.layers.concatenate([input_A, hidden2])
        main_output = self.main_output(concat)
        aux_output = self.aux_output(hidden2)
        return main_output, aux_output

model = WideAndDeepModel()
```

This example looks very much like the Functional API, except we do not need to create the inputs, we just use the `input` argument to the `call()` method, and we separate the creation of the layers¹⁵ in the constructor from their usage in the `call()` method. However, the big difference is that you can do pretty much anything you want in the `call()` method: for loops, `if` statements, low-level TensorFlow operations, your imagination is the limit (see [Chapter 12](#))! This makes it a great API for researchers experimenting with new ideas.

However, this extra flexibility comes at a cost: your model's architecture is hidden within the `call()` method, so Keras cannot easily inspect it, it cannot save or clone it, and when you call the `summary()` method, you only get a list of layers, without any information on how they are connected to each other. Moreover, Keras cannot check types and shapes ahead of time, and it is easier to make mistakes. So unless you really need that extra flexibility, you should probably stick to the Sequential API or the Functional API.

¹⁵ Keras models have an `output` attribute, so we cannot use that name for the main output layer, which is why we renamed it to `main_output`.



Keras models can be used just like regular layers, so you can easily compose them to build complex architectures.

Now that you know how to build and train neural nets using Keras, you will want to save them!

Saving and Restoring a Model

Saving a trained Keras model is as simple as it gets:

```
model.save("my_keras_model.h5")
```

Keras will save both the model's architecture (including every layer's hyperparameters) and the value of all the model parameters for every layer (e.g., connection weights and biases), using the HDF5 format. It also saves the optimizer (including its hyperparameters and any state it may have).

You will typically have a script that trains a model and saves it, and one or more scripts (or web services) that load the model and use it to make predictions. Loading the model is just as easy:

```
model = keras.models.load_model("my_keras_model.h5")
```



This will work when using the Sequential API or the Functional API, but unfortunately not when using Model subclassing. However, you can use `save_weights()` and `load_weights()` to at least save and restore the model parameters (but you will need to save and restore everything else yourself).

But what if training lasts several hours? This is quite common, especially when training on large datasets. In this case, you should not only save your model at the end of training, but also save checkpoints at regular intervals during training. But how can you tell the `fit()` method to save checkpoints? The answer is: using callbacks.

Using Callbacks

The `fit()` method accepts a `callbacks` argument that lets you specify a list of objects that Keras will call during training at the start and end of training, at the start and end of each epoch and even before and after processing each batch. For example, the `ModelCheckpoint` callback saves checkpoints of your model at regular intervals during training, by default at the end of each epoch:

```
[...] # build and compile the model
checkpoint_cb = keras.callbacks.ModelCheckpoint("my_keras_model.h5")
history = model.fit(X_train, y_train, epochs=10, callbacks=[checkpoint_cb])
```

Moreover, if you use a validation set during training, you can set `save_best_only=True` when creating the `ModelCheckpoint`. In this case, it will only save your model when its performance on the validation set is the best so far. This way, you do not need to worry about training for too long and overfitting the training set: simply restore the last model saved after training, and this will be the best model on the validation set. This is a simple way to implement early stopping (introduced in [Chapter 4](#)):

```
checkpoint_cb = keras.callbacks.ModelCheckpoint("my_keras_model.h5",
                                              save_best_only=True)
history = model.fit(X_train, y_train, epochs=10,
                  validation_data=(X_valid, y_valid),
                  callbacks=[checkpoint_cb])
model = keras.models.load_model("my_keras_model.h5") # rollback to best model
```

Another way to implement early stopping is to simply use the `EarlyStopping` callback. It will interrupt training when it measures no progress on the validation set for a number of epochs (defined by the `patience` argument), and it will optionally roll back to the best model. You can combine both callbacks to both save checkpoints of your model (in case your computer crashes), and actually interrupt training early when there is no more progress (to avoid wasting time and resources):

```
early_stopping_cb = keras.callbacks.EarlyStopping(patience=10,
                                                restore_best_weights=True)
history = model.fit(X_train, y_train, epochs=100,
                  validation_data=(X_valid, y_valid),
                  callbacks=[checkpoint_cb, early_stopping_cb])
```

The number of epochs can be set to a large value since training will stop automatically when there is no more progress. Moreover, there is no need to restore the best model saved in this case since the `EarlyStopping` callback will keep track of the best weights and restore them for us at the end of training.



There are many other callbacks available in the `keras.callbacks` package. See <https://keras.io/callbacks/>.

If you need extra control, you can easily write your own custom callbacks. For example, the following custom callback will display the ratio between the validation loss and the training loss during training (e.g., to detect overfitting):

```

class PrintValTrainRatioCallback(keras.callbacks.Callback):
    def on_epoch_end(self, epoch, logs):
        print("\nval/train: {:.2f}".format(logs["val_loss"] / logs["loss"]))

```

As you might expect, you can implement `on_train_begin()`, `on_train_end()`, `on_epoch_begin()`, `on_epoch_end()`, `on_batch_begin()` and `on_batch_end()`. Moreover, callbacks can also be used during evaluation and predictions, should you ever need them (e.g., for debugging). In this case, you should implement `on_test_begin()`, `on_test_end()`, `on_test_batch_begin()`, or `on_test_batch_end()` (called by `evaluate()`), or `on_predict_begin()`, `on_predict_end()`, `on_predict_batch_begin()`, or `on_predict_batch_end()` (called by `predict()`).

Now let's take a look at one more tool you should definitely have in your toolbox when using `tf.keras`: TensorBoard.

Visualization Using TensorBoard

TensorBoard is a great interactive visualization tool that you can use to view the learning curves during training, compare learning curves between multiple runs, visualize the computation graph, analyze training statistics, view images generated by your model, visualize complex multidimensional data projected down to 3D and automatically clustered for you, and more! This tool is installed automatically when you install TensorFlow, so you already have it!

To use it, you must modify your program so that it outputs the data you want to visualize to special binary log files called *event files*. Each binary data record is called a *summary*. The TensorBoard server will monitor the log directory, and it will automatically pick up the changes and update the visualizations: this allows you to visualize live data (with a short delay), such as the learning curves during training. In general, you want to point the TensorBoard server to a root log directory, and configure your program so that it writes to a different subdirectory every time it runs. This way, the same TensorBoard server instance will allow you to visualize and compare data from multiple runs of your program, without getting everything mixed up.

So let's start by defining the root log directory we will use for our TensorBoard logs, plus a small function that will generate a subdirectory path based on the current date and time, so that it is different at every run. You may want to include extra information in the log directory name, such as hyperparameter values that you are testing, to make it easier to know what you are looking at in TensorBoard:

```

root_logdir = os.path.join(os.getcwd(), "my_logs")

def get_run_logdir():
    import time
    run_id = time.strftime("run_%Y_%m_%d-%H_%M_%S")
    return os.path.join(root_logdir, run_id)

```

```
run_logdir = get_run_logdir() # e.g., './my_logs/run_2019_01_16-11_28_43'
```

Next, the good news is that Keras provides a nice TensorBoard callback:

```
[...] # Build and compile your model
tensorboard_cb = keras.callbacks.TensorBoard(run_logdir)
history = model.fit(X_train, y_train, epochs=30,
                    validation_data=(X_valid, y_valid),
                    callbacks=[tensorboard_cb])
```

And that's all there is to it! It could hardly be easier to use. If you run this code, the TensorBoard callback will take care of creating the log directory for you (along with its parent directories if needed), and during training it will create event files and write summaries to them. After running the program a second time (perhaps changing some hyperparameter value), you will end up with a directory structure similar to this one:

```
my_logs
├── run_2019_01_16-16_51_02
│   └── events.out.tfevents.1547628669.mycomputer.local.v2
└── run_2019_01_16-16_56_50
    └── events.out.tfevents.1547629020.mycomputer.local.v2
```

Next you need to start the TensorBoard server. If you installed TensorFlow within a virtualenv, you should activate it. Next, run the following command at the root of the project (or from anywhere else as long as you point to the appropriate log directory). If your shell cannot find the `tensorboard` script, then you must update your `PATH` environment variable so that it contains the directory in which the script was installed (alternatively, you can just replace `tensorboard` with `python3 -m tensorboard.main`).

```
$ tensorboard --logdir=./my_logs --port=6006
TensorBoard 2.0.0 at http://mycomputer.local:6006 (Press CTRL+C to quit)
```

Finally, open up a web browser to <http://localhost:6006>. You should see TensorBoard's web interface. Click on the SCALARS tab to view the learning curves (see [Figure 10-16](#)). Notice that the training loss went down nicely during both runs, but the second run went down much faster. Indeed, we used a larger learning rate by setting `optimizer=keras.optimizers.SGD(lr=0.05)` instead of `optimizer="sgd"`, which defaults to a learning rate of 0.001.

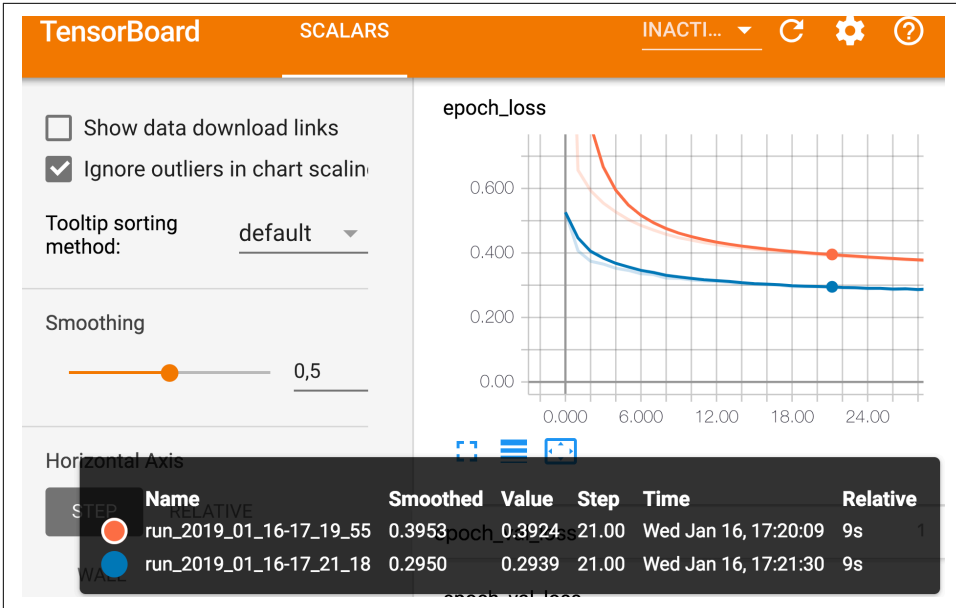

Figure 10-16. Visualizing Learning Curves with TensorBoard

Unfortunately, at the time of writing, no other data is exported by the TensorBoard callback, but this issue will probably be fixed by the time you read these lines. In TensorFlow 1, this callback exported the computation graph and many useful statistics: type `help(keras.callbacks.TensorBoard)` to see all the options.

Let's summarize what you learned so far in this chapter: we saw where neural nets came from, what an MLP is and how you can use it for classification and regression, how to build MLPs using `tf.keras`'s Sequential API, or more complex architectures using the Functional API or Model Subclassing, you learned how to save and restore a model, use callbacks for checkpointing, early stopping, and more, and finally how to use TensorBoard for visualization. You can already go ahead and use neural networks to tackle many problems! However, you may wonder how to choose the number of hidden layers, the number of neurons in the network, and all the other hyperparameters. Let's look at this now.

Fine-Tuning Neural Network Hyperparameters

The flexibility of neural networks is also one of their main drawbacks: there are many hyperparameters to tweak. Not only can you use any imaginable network architecture, but even in a simple MLP you can change the number of layers, the number of neurons per layer, the type of activation function to use in each layer, the weight initi-

alization logic, and much more. How do you know what combination of hyperparameters is the best for your task?

One option is to simply try many combinations of hyperparameters and see which one works best on the validation set (or using K-fold cross-validation). For this, one approach is simply use `GridSearchCV` or `RandomizedSearchCV` to explore the hyperparameter space, as we did in [Chapter 2](#). For this, we need to wrap our Keras models in objects that mimic regular Scikit-Learn regressors. The first step is to create a function that will build and compile a Keras model, given a set of hyperparameters:

```
def build_model(n_hidden=1, n_neurons=30, learning_rate=3e-3, input_shape=[8]):
    model = keras.models.Sequential()
    options = {"input_shape": input_shape}
    for layer in range(n_hidden):
        model.add(keras.layers.Dense(n_neurons, activation="relu", **options))
        options = {}
    model.add(keras.layers.Dense(1, **options))
    optimizer = keras.optimizers.SGD(learning_rate)
    model.compile(loss="mse", optimizer=optimizer)
    return model
```

This function creates a simple `Sequential` model for univariate regression (only one output neuron), with the given input shape and the given number of hidden layers and neurons, and it compiles it using an `SGD` optimizer configured with the given learning rate. The `options` dict is used to ensure that the first layer is properly given the input shape (note that if `n_hidden=0`, the first layer will be the output layer). It is good practice to provide reasonable defaults to as many hyperparameters as you can, as Scikit-Learn does.

Next, let's create a `KerasRegressor` based on this `build_model()` function:

```
keras_reg = keras.wrappers.scikit_learn.KerasRegressor(build_model)
```

The `KerasRegressor` object is a thin wrapper around the Keras model built using `build_model()`. Since we did not specify any hyperparameter when creating it, it will just use the default hyperparameters we defined in `build_model()`. Now we can use this object like a regular Scikit-Learn regressor: we can train it using its `fit()` method, then evaluate it using its `score()` method, and use it to make predictions using its `predict()` method. Note that any extra parameter you pass to the `fit()` method will simply get passed to the underlying Keras model. Also note that the score will be the opposite of the MSE because Scikit-Learn wants scores, not losses (i.e., higher should be better).

```
keras_reg.fit(X_train, y_train, epochs=100,
              validation_data=(X_valid, y_valid),
              callbacks=[keras.callbacks.EarlyStopping(patience=10)])
mse_test = keras_reg.score(X_test, y_test)
y_pred = keras_reg.predict(X_new)
```

However, we do not actually want to train and evaluate a single model like this, we want to train hundreds of variants and see which one performs best on the validation set. Since there are many hyperparameters, it is preferable to use a randomized search rather than grid search (as we discussed in [Chapter 2](#)). Let's try to explore the number of hidden layers, the number of neurons and the learning rate:

```
from scipy.stats import reciprocal
from sklearn.model_selection import RandomizedSearchCV

param_distrib = {
    "n_hidden": [0, 1, 2, 3],
    "n_neurons": np.arange(1, 100),
    "learning_rate": reciprocal(3e-4, 3e-2),
}

rnd_search_cv = RandomizedSearchCV(keras_reg, param_distrib, n_iter=10, cv=3)
rnd_search_cv.fit(X_train, y_train, epochs=100,
                  validation_data=(X_valid, y_valid),
                  callbacks=[keras.callbacks.EarlyStopping(patience=10)])
```

As you can see, this is identical to what we did in [Chapter 2](#), with the exception that we pass extra parameters to the `fit()` method: they simply get relayed to the underlying Keras models. Note that `RandomizedSearchCV` uses K-fold cross-validation, so it does not use `X_valid` and `y_valid`. These are just used for early stopping.

The exploration may last many hours depending on the hardware, the size of the dataset, the complexity of the model and the value of `n_iter` and `cv`. When it is over, you can access the best parameters found, the best score, and the trained Keras model like this:

```
>>> rnd_search_cv.best_params_
{'learning_rate': 0.0033625641252688094, 'n_hidden': 2, 'n_neurons': 42}
>>> rnd_search_cv.best_score_
-0.3189529188278931
>>> model = rnd_search_cv.best_estimator_.model
```

You can now save this model, evaluate it on the test set, and if you are satisfied with its performance, deploy it to production. Using randomized search is not too hard, and it works well for many fairly simple problems. However, when training is slow (e.g., for more complex problems with larger datasets), this approach will only explore a tiny portion of the hyperparameter space. You can partially alleviate this problem by assisting the search process manually: first run a quick random search using wide ranges of hyperparameter values, then run another search using smaller ranges of values centered on the best ones found during the first run, and so on. This will hopefully zoom in to a good set of hyperparameters. However, this is very time consuming, and probably not the best use of your time.

Fortunately, there are many techniques to explore a search space much more efficiently than randomly. Their core idea is simple: when a region of the space turns out

to be good, it should be explored more. This takes care of the “zooming” process for you and leads to much better solutions in much less time. Here are a few Python libraries you can use to optimize hyperparameters:

- **Hyperopt**: a popular Python library for optimizing over all sorts of complex search spaces (including real values such as the learning rate, or discrete values such as the number of layers).
- **Hyperas**, **kopt** or **Talos**: optimizing hyperparameters for Keras model (the first two are based on Hyperopt).
- **Scikit-Optimize** (skopt): a general-purpose optimization library. The Bayes SearchCV class performs Bayesian optimization using an interface similar to Grid SearchCV.
- **Spearmint**: a Bayesian optimization library.
- **Sklearn-Deap**: a hyperparameter optimization library based on evolutionary algorithms, also with a GridSearchCV-like interface.
- And many more!

Moreover, many companies offer services for hyperparameter optimization. For example Google Cloud ML Engine has a **hyperparameter tuning service**. Other companies provide APIs for hyperparameter optimization, such as **Arimo**, **SigOpt**, **Oscar** and many more.

Hyperparameter tuning is still an active area of research. Evolutionary algorithms are making a comeback lately. For example, check out DeepMind’s excellent **2017 paper**¹⁶, where they jointly optimize a population of models and their hyperparameters. Google also used an evolutionary approach, not just to search for hyperparameters, but also to look for the best neural network architecture for the problem. They call this *AutoML*, and it is already available as a **cloud service**. Perhaps the days of building neural networks manually will soon be over? Check out Google’s **post** on this topic. In fact, evolutionary algorithms have also been used successfully to train individual neural networks, replacing the ubiquitous Gradient Descent! See this **2017 post** by Uber where they introduce their *Deep Neuroevolution* technique.

Despite all this exciting progress, and all these tools and services, it still helps to have an idea of what values are reasonable for each hyperparameter, so you can build a quick prototype, and restrict the search space. Here are a few guidelines for choosing the number of hidden layers and neurons in an MLP, and selecting good values for some of the main hyperparameters.

¹⁶ “Population Based Training of Neural Networks,” Max Jaderberg et al. (2017).

Number of Hidden Layers

For many problems, you can just begin with a single hidden layer and you will get reasonable results. It has actually been shown that an MLP with just one hidden layer can model even the most complex functions provided it has enough neurons. For a long time, these facts convinced researchers that there was no need to investigate any deeper neural networks. But they overlooked the fact that deep networks have a much higher *parameter efficiency* than shallow ones: they can model complex functions using exponentially fewer neurons than shallow nets, allowing them to reach much better performance with the same amount of training data.

To understand why, suppose you are asked to draw a forest using some drawing software, but you are forbidden to use copy/paste. You would have to draw each tree individually, branch per branch, leaf per leaf. If you could instead draw one leaf, copy/paste it to draw a branch, then copy/paste that branch to create a tree, and finally copy/paste this tree to make a forest, you would be finished in no time. Real-world data is often structured in such a hierarchical way and Deep Neural Networks automatically take advantage of this fact: lower hidden layers model low-level structures (e.g., line segments of various shapes and orientations), intermediate hidden layers combine these low-level structures to model intermediate-level structures (e.g., squares, circles), and the highest hidden layers and the output layer combine these intermediate structures to model high-level structures (e.g., faces).

Not only does this hierarchical architecture help DNNs converge faster to a good solution, it also improves their ability to generalize to new datasets. For example, if you have already trained a model to recognize faces in pictures, and you now want to train a new neural network to recognize hairstyles, then you can kickstart training by reusing the lower layers of the first network. Instead of randomly initializing the weights and biases of the first few layers of the new neural network, you can initialize them to the value of the weights and biases of the lower layers of the first network. This way the network will not have to learn from scratch all the low-level structures that occur in most pictures; it will only have to learn the higher-level structures (e.g., hairstyles). This is called *transfer learning*.

In summary, for many problems you can start with just one or two hidden layers and it will work just fine (e.g., you can easily reach above 97% accuracy on the MNIST dataset using just one hidden layer with a few hundred neurons, and above 98% accuracy using two hidden layers with the same total amount of neurons, in roughly the same amount of training time). For more complex problems, you can gradually ramp up the number of hidden layers, until you start overfitting the training set. Very complex tasks, such as large image classification or speech recognition, typically require networks with dozens of layers (or even hundreds, but not fully connected ones, as we will see in [Chapter 14](#)), and they need a huge amount of training data. However, you will rarely have to train such networks from scratch: it is much more common to

reuse parts of a pretrained state-of-the-art network that performs a similar task. Training will be a lot faster and require much less data (we will discuss this in [Chapter 11](#)).

Number of Neurons per Hidden Layer

Obviously the number of neurons in the input and output layers is determined by the type of input and output your task requires. For example, the MNIST task requires $28 \times 28 = 784$ input neurons and 10 output neurons.

As for the hidden layers, it used to be a common practice to size them to form a pyramid, with fewer and fewer neurons at each layer—the rationale being that many low-level features can coalesce into far fewer high-level features. For example, a typical neural network for MNIST may have three hidden layers, the first with 300 neurons, the second with 200, and the third with 100. However, this practice has been largely abandoned now, as it seems that simply using the same number of neurons in all hidden layers performs just as well in most cases, or even better, and there is just one hyperparameter to tune instead of one per layer—for example, all hidden layers could simply have 150 neurons. However, depending on the dataset, it can sometimes help to make the first hidden layer bigger than the others.

Just like for the number of layers, you can try increasing the number of neurons gradually until the network starts overfitting. In general you will get more bang for the buck by increasing the number of layers than the number of neurons per layer. Unfortunately, as you can see, finding the perfect amount of neurons is still somewhat of a dark art.

A simpler approach is to pick a model with more layers and neurons than you actually need, then use early stopping to prevent it from overfitting (and other regularization techniques, such as *dropout*, as we will see in [Chapter 11](#)). This has been dubbed the “stretch pants” approach:¹⁷ instead of wasting time looking for pants that perfectly match your size, just use large stretch pants that will shrink down to the right size.

Learning Rate, Batch Size and Other Hyperparameters

The number of hidden layers and neurons are not the only hyperparameters you can tweak in an MLP. Here are some of the most important ones, and some tips on how to set them:

- The learning rate is arguably the most important hyperparameter. In general, the optimal learning rate is about half of the maximum learning rate (i.e., the learn-

¹⁷ By Vincent Vanhoucke in his [Deep Learning class](#) on Udacity.com.

ing rate above which the training algorithm diverges, as we saw in [Chapter 4](#)). So a simple approach for tuning the learning rate is to start with a large value that makes the training algorithm diverge, then divide this value by 3 and try again, and repeat until the training algorithm stops diverging. At that point, you generally won't be too far from the optimal learning rate. That said, it is sometimes useful to reduce the learning rate during training; we will discuss this in [Chapter 11](#).

- Choosing a better optimizer than plain old Mini-batch Gradient Descent (and tuning its hyperparameters) is also quite important. We will discuss this in [Chapter 11](#).
- The batch size can also have a significant impact on your model's performance and the training time. In general the optimal batch size will be lower than 32 (in April 2018, Yann Lecun even tweeted "*Friends don't let friends use mini-batches larger than 32*"). A small batch size ensures that each training iteration is very fast, and although a large batch size will give a more precise estimate of the gradients, in practice this does not matter much since the optimization landscape is quite complex and the direction of the true gradients do not point precisely in the direction of the optimum. However, having a batch size greater than 10 helps take advantage of hardware and software optimizations, in particular for matrix multiplications, so it will speed up training. Moreover, if you use *Batch Normalization* (see [Chapter 11](#)), the batch size should not be too small (in general no less than 20).
- We discussed the choice of the activation function earlier in this chapter: in general, the ReLU activation function will be a good default for all hidden layers. For the output layer, it really depends on your task.
- In most cases, the number of training iterations does not actually need to be tweaked: just use early stopping instead.

For more best practices, make sure to read Yoshua Bengio's great [2012 paper](#)¹⁸, which presents many practical recommendations for deep networks.

This concludes this introduction to artificial neural networks and their implementation with Keras. In the next few chapters, we will discuss techniques to train very deep nets, we will see how to customize your models using TensorFlow's lower-level API and how to load and preprocess data efficiently using the Data API, and we will dive into other popular neural network architectures: convolutional neural networks for image processing, recurrent neural networks for sequential data, autoencoders for

¹⁸ "Practical recommendations for gradient-based training of deep architectures," Yoshua Bengio (2012).

representation learning, and generative adversarial networks to model and generate data.¹⁹

Exercises

1. Visit the TensorFlow Playground at <https://playground.tensorflow.org/>
 - Layers and patterns: try training the default neural network by clicking the run button (top left). Notice how it quickly finds a good solution for the classification task. Notice that the neurons in the first hidden layer have learned simple patterns, while the neurons in the second hidden layer have learned to combine the simple patterns of the first hidden layer into more complex patterns. In general, the more layers, the more complex the patterns can be.
 - Activation function: try replacing the Tanh activation function with the ReLU activation function, and train the network again. Notice that it finds a solution even faster, but this time the boundaries are linear. This is due to the shape of the ReLU function.
 - Local minima: modify the network architecture to have just one hidden layer with three neurons. Train it multiple times (to reset the network weights, click the reset button next to the play button). Notice that the training time varies a lot, and sometimes it even gets stuck in a local minimum.
 - Too small: now remove one neuron to keep just 2. Notice that the neural network is now incapable of finding a good solution, even if you try multiple times. The model has too few parameters and it systematically underfits the training set.
 - Large enough: next, set the number of neurons to 8 and train the network several times. Notice that it is now consistently fast and never gets stuck. This highlights an important finding in neural network theory: large neural networks almost never get stuck in local minima, and even when they do these local optima are almost as good as the global optimum. However, they can still get stuck on long plateaus for a long time.
 - Deep net and vanishing gradients: now change the dataset to be the spiral (bottom right dataset under “DATA”). Change the network architecture to have 4 hidden layers with 8 neurons each. Notice that training takes much longer, and often gets stuck on plateaus for long periods of time. Also notice that the neurons in the highest layers (i.e. on the right) tend to evolve faster than the neurons in the lowest layers (i.e. on the left). This problem, called the “vanishing gradients” problem, can be alleviated using better weight initialization and

¹⁹ A few extra ANN architectures are presented in ???.

other techniques, better optimizers (such as AdaGrad or Adam), or using Batch Normalization.

- More: go ahead and play with the other parameters to get a feel of what they do. In fact, you should definitely play with this UI for at least one hour, it will grow your intuitions about neural networks significantly.
2. Draw an ANN using the original artificial neurons (like the ones in [Figure 10-3](#)) that computes $A \oplus B$ (where \oplus represents the XOR operation). Hint: $A \oplus B = (A \wedge \neg B) \vee (\neg A \wedge B)$.
 3. Why is it generally preferable to use a Logistic Regression classifier rather than a classical Perceptron (i.e., a single layer of threshold logic units trained using the Perceptron training algorithm)? How can you tweak a Perceptron to make it equivalent to a Logistic Regression classifier?
 4. Why was the logistic activation function a key ingredient in training the first MLPs?
 5. Name three popular activation functions. Can you draw them?
 6. Suppose you have an MLP composed of one input layer with 10 passthrough neurons, followed by one hidden layer with 50 artificial neurons, and finally one output layer with 3 artificial neurons. All artificial neurons use the ReLU activation function.
 - What is the shape of the input matrix \mathbf{X} ?
 - What about the shape of the hidden layer's weight vector \mathbf{W}_h , and the shape of its bias vector \mathbf{b}_h ?
 - What is the shape of the output layer's weight vector \mathbf{W}_o , and its bias vector \mathbf{b}_o ?
 - What is the shape of the network's output matrix \mathbf{Y} ?
 - Write the equation that computes the network's output matrix \mathbf{Y} as a function of \mathbf{X} , \mathbf{W}_h , \mathbf{b}_h , \mathbf{W}_o and \mathbf{b}_o .
 7. How many neurons do you need in the output layer if you want to classify email into spam or ham? What activation function should you use in the output layer? If instead you want to tackle MNIST, how many neurons do you need in the output layer, using what activation function? Answer the same questions for getting your network to predict housing prices as in [Chapter 2](#).
 8. What is backpropagation and how does it work? What is the difference between backpropagation and reverse-mode autodiff?
 9. Can you list all the hyperparameters you can tweak in an MLP? If the MLP overfits the training data, how could you tweak these hyperparameters to try to solve the problem?

10. Train a deep MLP on the MNIST dataset and see if you can get over 98% precision. Try adding all the bells and whistles (i.e., save checkpoints, use early stopping, plot learning curves using TensorBoard, and so on).

Solutions to these exercises are available in [???](#).

Training Deep Neural Networks



With Early Release ebooks, you get books in their earliest form—the author’s raw and unedited content as he or she writes—so you can take advantage of these technologies long before the official release of these titles. The following will be Chapter 11 in the final release of the book.

In **Chapter 10** we introduced artificial neural networks and trained our first deep neural networks. But they were very shallow nets, with just a few hidden layers. What if you need to tackle a very complex problem, such as detecting hundreds of types of objects in high-resolution images? You may need to train a much deeper DNN, perhaps with 10 layers or much more, each containing hundreds of neurons, connected by hundreds of thousands of connections. This would not be a walk in the park:

- First, you would be faced with the tricky *vanishing gradients* problem (or the related *exploding gradients* problem) that affects deep neural networks and makes lower layers very hard to train.
- Second, you might not have enough training data for such a large network, or it might be too costly to label.
- Third, training may be extremely slow.
- Fourth, a model with millions of parameters would severely risk overfitting the training set, especially if there are not enough training instances, or they are too noisy.

In this chapter, we will go through each of these problems in turn and present techniques to solve them. We will start by explaining the vanishing gradients problem and exploring some of the most popular solutions to this problem. Next, we will look at transfer learning and unsupervised pretraining, which can help you tackle complex

tasks even when you have little labeled data. Then we will discuss various optimizers that can speed up training large models tremendously compared to plain Gradient Descent. Finally, we will go through a few popular regularization techniques for large neural networks.

With these tools, you will be able to train very deep nets: welcome to Deep Learning!

Vanishing/Exploding Gradients Problems

As we discussed in [Chapter 10](#), the backpropagation algorithm works by going from the output layer to the input layer, propagating the error gradient on the way. Once the algorithm has computed the gradient of the cost function with regards to each parameter in the network, it uses these gradients to update each parameter with a Gradient Descent step.

Unfortunately, gradients often get smaller and smaller as the algorithm progresses down to the lower layers. As a result, the Gradient Descent update leaves the lower layer connection weights virtually unchanged, and training never converges to a good solution. This is called the *vanishing gradients* problem. In some cases, the opposite can happen: the gradients can grow bigger and bigger, so many layers get insanely large weight updates and the algorithm diverges. This is the *exploding gradients* problem, which is mostly encountered in recurrent neural networks (see [???](#)). More generally, deep neural networks suffer from unstable gradients; different layers may learn at widely different speeds.

Although this unfortunate behavior has been empirically observed for quite a while (it was one of the reasons why deep neural networks were mostly abandoned for a long time), it is only around 2010 that significant progress was made in understanding it. A paper titled “[Understanding the Difficulty of Training Deep Feedforward Neural Networks](#)” by Xavier Glorot and Yoshua Bengio¹ found a few suspects, including the combination of the popular logistic sigmoid activation function and the weight initialization technique that was most popular at the time, namely random initialization using a normal distribution with a mean of 0 and a standard deviation of 1. In short, they showed that with this activation function and this initialization scheme, the variance of the outputs of each layer is much greater than the variance of its inputs. Going forward in the network, the variance keeps increasing after each layer until the activation function saturates at the top layers. This is actually made worse by the fact that the logistic function has a mean of 0.5, not 0 (the hyperbolic tangent function has a mean of 0 and behaves slightly better than the logistic function in deep networks).

¹ “Understanding the Difficulty of Training Deep Feedforward Neural Networks,” X. Glorot, Y Bengio (2010).

Looking at the logistic activation function (see [Figure 11-1](#)), you can see that when inputs become large (negative or positive), the function saturates at 0 or 1, with a derivative extremely close to 0. Thus when backpropagation kicks in, it has virtually no gradient to propagate back through the network, and what little gradient exists keeps getting diluted as backpropagation progresses down through the top layers, so there is really nothing left for the lower layers.

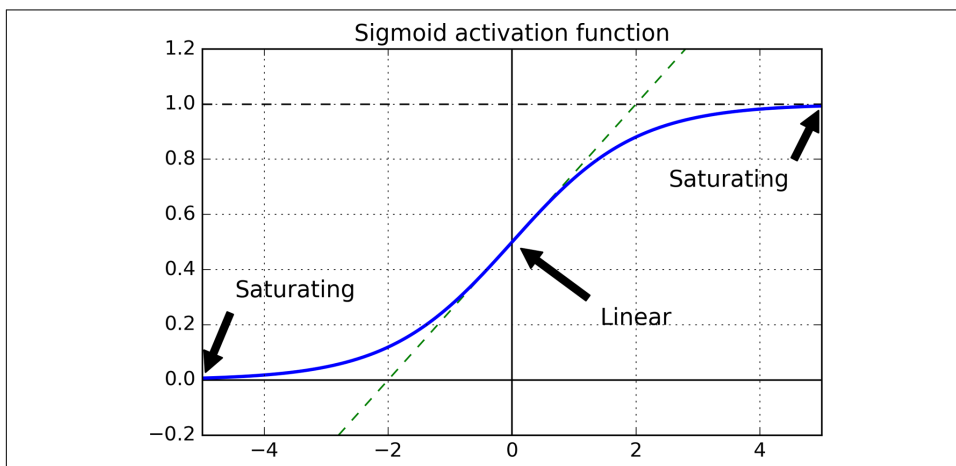

Figure 11-1. Logistic activation function saturation

Glorot and He Initialization

In their paper, Glorot and Bengio propose a way to significantly alleviate this problem. We need the signal to flow properly in both directions: in the forward direction when making predictions, and in the reverse direction when backpropagating gradients. We don't want the signal to die out, nor do we want it to explode and saturate. For the signal to flow properly, the authors argue that we need the variance of the outputs of each layer to be equal to the variance of its inputs,² and we also need the gradients to have equal variance before and after flowing through a layer in the reverse direction (please check out the paper if you are interested in the mathematical details). It is actually not possible to guarantee both unless the layer has an equal number of inputs and neurons (these numbers are called the *fan-in* and *fan-out* of the layer), but they proposed a good compromise that has proven to work very well in practice: the connection weights of each layer must be initialized randomly as

² Here's an analogy: if you set a microphone amplifier's knob too close to zero, people won't hear your voice, but if you set it too close to the max, your voice will be saturated and people won't understand what you are saying. Now imagine a chain of such amplifiers: they all need to be set properly in order for your voice to come out loud and clear at the end of the chain. Your voice has to come out of each amplifier at the same amplitude as it came in.

described in Equation 11-1, where $fan_{avg} = (fan_{in} + fan_{out})/2$. This initialization strategy is called *Xavier initialization* (after the author's first name) or *Glorot initialization* (after his last name).

Equation 11-1. Glorot initialization (when using the logistic activation function)

Normal distribution with mean 0 and variance $\sigma^2 = \frac{1}{fan_{avg}}$

Or a uniform distribution between $-r$ and $+r$, with $r = \sqrt{\frac{3}{fan_{avg}}}$

If you just replace fan_{avg} with fan_{in} in Equation 11-1, you get an initialization strategy that was actually already proposed by Yann LeCun in the 1990s, called *LeCun initialization*, which was even recommended in the 1998 book *Neural Networks: Tricks of the Trade* by Genevieve Orr and Klaus-Robert Müller (Springer). It is equivalent to Glorot initialization when $fan_{in} = fan_{out}$. It took over a decade for researchers to realize just how important this trick really is. Using Glorot initialization can speed up training considerably, and it is one of the tricks that led to the current success of Deep Learning.

Some papers³ have provided similar strategies for different activation functions. These strategies differ only by the scale of the variance and whether they use fan_{avg} or fan_{in} , as shown in Table 11-1 (for the uniform distribution, just compute $r = \sqrt{3\sigma^2}$). The initialization strategy for the ReLU activation function (and its variants, including the ELU activation described shortly) is sometimes called *He initialization* (after the last name of its author). The SELU activation function will be explained later in this chapter. It should be used with LeCun initialization (preferably with a normal distribution, as we will see).

Table 11-1. Initialization parameters for each type of activation function

Initialization	Activation functions	σ^2 (Normal)
Glorot	None, Tanh, Logistic, Softmax	$1 / fan_{avg}$
He	ReLU & variants	$2 / fan_{in}$
LeCun	SELU	$1 / fan_{in}$

By default, Keras uses Glorot initialization with a uniform distribution. You can change this to He initialization by setting `kernel_initializer="he_uniform"` or `kernel_initializer="he_normal"` when creating a layer, like this:

³ Such as "Delving Deep into Rectifiers: Surpassing Human-Level Performance on ImageNet Classification," K. He et al. (2015).

```
keras.layers.Dense(10, activation="relu", kernel_initializer="he_normal")
```

If you want He initialization with a uniform distribution, but based on fan_{avg} rather than fan_{in} , you can use the `VarianceScaling` initializer like this:

```
he_avg_init = keras.initializers.VarianceScaling(scale=2., mode='fan_avg',  
                                                  distribution='uniform')  
keras.layers.Dense(10, activation="sigmoid", kernel_initializer=he_avg_init)
```

Nonsaturating Activation Functions

One of the insights in the 2010 paper by Glorot and Bengio was that the vanishing/exploding gradients problems were in part due to a poor choice of activation function. Until then most people had assumed that if Mother Nature had chosen to use roughly sigmoid activation functions in biological neurons, they must be an excellent choice. But it turns out that other activation functions behave much better in deep neural networks, in particular the ReLU activation function, mostly because it does not saturate for positive values (and also because it is quite fast to compute).

Unfortunately, the ReLU activation function is not perfect. It suffers from a problem known as the *dying ReLUs*: during training, some neurons effectively die, meaning they stop outputting anything other than 0. In some cases, you may find that half of your network's neurons are dead, especially if you used a large learning rate. A neuron dies when its weights get tweaked in such a way that the weighted sum of its inputs are negative for all instances in the training set. When this happens, it just keeps outputting 0s, and gradient descent does not affect it anymore since the gradient of the ReLU function is 0 when its input is negative.⁴

To solve this problem, you may want to use a variant of the ReLU function, such as the *leaky ReLU*. This function is defined as $\text{LeakyReLU}_\alpha(z) = \max(\alpha z, z)$ (see [Figure 11-2](#)). The hyperparameter α defines how much the function “leaks”: it is the slope of the function for $z < 0$, and is typically set to 0.01. This small slope ensures that leaky ReLUs never die; they can go into a long coma, but they have a chance to eventually wake up. A [2015 paper](#)⁵ compared several variants of the ReLU activation function and one of its conclusions was that the leaky variants always outperformed the strict ReLU activation function. In fact, setting $\alpha = 0.2$ (huge leak) seemed to result in better performance than $\alpha = 0.01$ (small leak). They also evaluated the *randomized leaky ReLU* (RReLU), where α is picked randomly in a given range during training, and it is fixed to an average value during testing. It also performed fairly well and seemed to act as a regularizer (reducing the risk of overfitting the training set).

⁴ Unless it is part of the first hidden layer, a dead neuron may sometimes come back to life: gradient descent may indeed tweak neurons in the layers below in such a way that the weighted sum of the dead neuron's inputs is positive again.

⁵ “Empirical Evaluation of Rectified Activations in Convolution Network,” B. Xu et al. (2015).

Finally, they also evaluated the *parametric leaky ReLU* (PReLU), where α is authorized to be learned during training (instead of being a hyperparameter, it becomes a parameter that can be modified by backpropagation like any other parameter). This was reported to strongly outperform ReLU on large image datasets, but on smaller datasets it runs the risk of overfitting the training set.

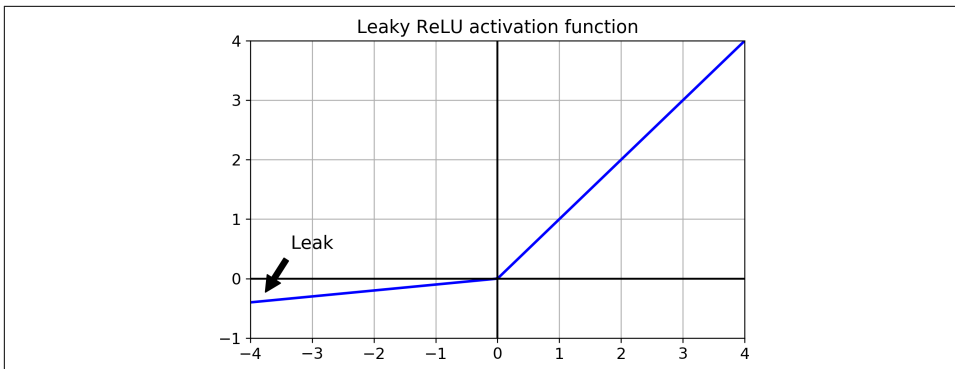

Figure 11-2. Leaky ReLU

Last but not least, a [2015 paper](#) by Djork-Arné Clevert et al.⁶ proposed a new activation function called the *exponential linear unit* (ELU) that outperformed all the ReLU variants in their experiments: training time was reduced and the neural network performed better on the test set. It is represented in [Figure 11-3](#), and [Equation 11-2](#) shows its definition.

Equation 11-2. ELU activation function

$$\text{ELU}_{\alpha}(z) = \begin{cases} \alpha(\exp(z) - 1) & \text{if } z < 0 \\ z & \text{if } z \geq 0 \end{cases}$$

⁶ “Fast and Accurate Deep Network Learning by Exponential Linear Units (ELUs),” D. Clevert, T. Unterthiner, S. Hochreiter (2015).

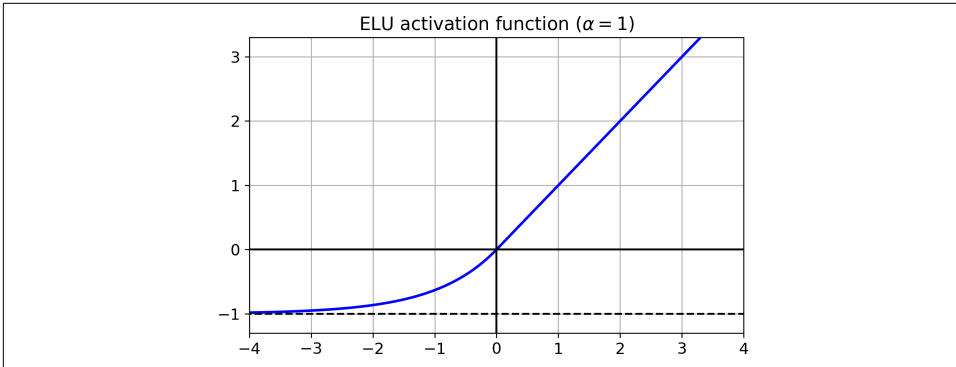

Figure 11-3. ELU activation function

It looks a lot like the ReLU function, with a few major differences:

- First it takes on negative values when $z < 0$, which allows the unit to have an average output closer to 0. This helps alleviate the vanishing gradients problem, as discussed earlier. The hyperparameter α defines the value that the ELU function approaches when z is a large negative number. It is usually set to 1, but you can tweak it like any other hyperparameter if you want.
- Second, it has a nonzero gradient for $z < 0$, which avoids the dead neurons problem.
- Third, if α is equal to 1 then the function is smooth everywhere, including around $z = 0$, which helps speed up Gradient Descent, since it does not bounce as much left and right of $z = 0$.

The main drawback of the ELU activation function is that it is slower to compute than the ReLU and its variants (due to the use of the exponential function), but during training this is compensated by the faster convergence rate. However, at test time an ELU network will be slower than a ReLU network.

Moreover, in a [2017 paper](#)⁷ by Günter Klambauer et al., called “Self-Normalizing Neural Networks”, the authors showed that if you build a neural network composed exclusively of a stack of dense layers, and if all hidden layers use the SELU activation function (which is just a scaled version of the ELU activation function, as its name suggests), then the network will *self-normalize*: the output of each layer will tend to preserve mean 0 and standard deviation 1 during training, which solves the vanishing/exploding gradients problem. As a result, this activation function often outper-

⁷ “Self-Normalizing Neural Networks,” G. Klambauer, T. Unterthiner and A. Mayr (2017).

forms other activation functions very significantly for such neural nets (especially deep ones). However, there are a few conditions for self-normalization to happen:

- The input features must be standardized (mean 0 and standard deviation 1).
- Every hidden layer's weights must also be initialized using LeCun normal initialization. In Keras, this means setting `kernel_initializer="lecun_normal"`.
- The network's architecture must be sequential. Unfortunately, if you try to use SELU in non-sequential architectures, such as recurrent networks (see ???) or networks with *skip connections* (i.e., connections that skip layers, such as in wide & deep nets), self-normalization will not be guaranteed, so SELU will not necessarily outperform other activation functions.
- The paper only guarantees self-normalization if all layers are dense. However, in practice the SELU activation function seems to work great with convolutional neural nets as well (see [Chapter 14](#)).



So which activation function should you use for the hidden layers of your deep neural networks? Although your mileage will vary, in general SELU > ELU > leaky ReLU (and its variants) > ReLU > tanh > logistic. If the network's architecture prevents it from self-normalizing, then ELU may perform better than SELU (since SELU is not smooth at $z = 0$). If you care a lot about runtime latency, then you may prefer leaky ReLU. If you don't want to tweak yet another hyperparameter, you may just use the default α values used by Keras (e.g., 0.3 for the leaky ReLU). If you have spare time and computing power, you can use cross-validation to evaluate other activation functions, in particular RReLU if your network is overfitting, or PReLU if you have a huge training set.

To use the leaky ReLU activation function, you must create a LeakyReLU instance like this:

```
leaky_relu = keras.layers.LeakyReLU(alpha=0.2)
layer = keras.layers.Dense(10, activation=leaky_relu,
                             kernel_initializer="he_normal")
```

For PReLU, just replace `LeakyReLU(alpha=0.2)` with `PReLU()`. There is currently no official implementation of RReLU in Keras, but you can fairly easily implement your own (see the exercises at the end of [Chapter 12](#)).

For SELU activation, just set `activation="selu"` and `kernel_initializer="lecun_normal"` when creating a layer:

```
layer = keras.layers.Dense(10, activation="selu",
                             kernel_initializer="lecun_normal")
```

Batch Normalization

Although using He initialization along with ELU (or any variant of ReLU) can significantly reduce the vanishing/exploding gradients problems at the beginning of training, it doesn't guarantee that they won't come back during training.

In a 2015 paper,⁸ Sergey Ioffe and Christian Szegedy proposed a technique called *Batch Normalization* (BN) to address the vanishing/exploding gradients problems. The technique consists of adding an operation in the model just before or after the activation function of each hidden layer, simply zero-centering and normalizing each input, then scaling and shifting the result using two new parameter vectors per layer: one for scaling, the other for shifting. In other words, this operation lets the model learn the optimal scale and mean of each of the layer's inputs. In many cases, if you add a BN layer as the very first layer of your neural network, you do not need to standardize your training set (e.g., using a `StandardScaler`): the BN layer will do it for you (well, approximately, since it only looks at one batch at a time, and it can also rescale and shift each input feature).

In order to zero-center and normalize the inputs, the algorithm needs to estimate each input's mean and standard deviation. It does so by evaluating the mean and standard deviation of each input over the current mini-batch (hence the name "Batch Normalization"). The whole operation is summarized in [Equation 11-3](#).

Equation 11-3. Batch Normalization algorithm

$$\begin{aligned} 1. \quad \boldsymbol{\mu}_B &= \frac{1}{m_B} \sum_{i=1}^{m_B} \mathbf{x}^{(i)} \\ 2. \quad \sigma_B^2 &= \frac{1}{m_B} \sum_{i=1}^{m_B} (\mathbf{x}^{(i)} - \boldsymbol{\mu}_B)^2 \\ 3. \quad \hat{\mathbf{x}}^{(i)} &= \frac{\mathbf{x}^{(i)} - \boldsymbol{\mu}_B}{\sqrt{\sigma_B^2 + \epsilon}} \\ 4. \quad \mathbf{z}^{(i)} &= \boldsymbol{\gamma} \otimes \hat{\mathbf{x}}^{(i)} + \boldsymbol{\beta} \end{aligned}$$

- $\boldsymbol{\mu}_B$ is the vector of input means, evaluated over the whole mini-batch B (it contains one mean per input).

⁸ "Batch Normalization: Accelerating Deep Network Training by Reducing Internal Covariate Shift," S. Ioffe and C. Szegedy (2015).

- σ_B is the vector of input standard deviations, also evaluated over the whole mini-batch (it contains one standard deviation per input).
- m_B is the number of instances in the mini-batch.
- $\hat{\mathbf{x}}^{(i)}$ is the vector of zero-centered and normalized inputs for instance i .
- $\boldsymbol{\gamma}$ is the output scale parameter vector for the layer (it contains one scale parameter per input).
- \otimes represents element-wise multiplication (each input is multiplied by its corresponding output scale parameter).
- $\boldsymbol{\beta}$ is the output shift (offset) parameter vector for the layer (it contains one offset parameter per input). Each input is offset by its corresponding shift parameter.
- ϵ is a tiny number to avoid division by zero (typically 10^{-5}). This is called a *smoothing term*.
- $\mathbf{z}^{(i)}$ is the output of the BN operation: it is a rescaled and shifted version of the inputs.

So during training, BN just standardizes its inputs then rescales and offsets them. Good! What about at test time? Well it is not that simple. Indeed, we may need to make predictions for individual instances rather than for batches of instances: in this case, we will have no way to compute each input's mean and standard deviation. Moreover, even if we do have a batch of instances, it may be too small, or the instances may not be independent and identically distributed (IID), so computing statistics over the batch instances would be unreliable (during training, the batches should not be too small, if possible more than 30 instances, and all instances should be IID, as we saw in [Chapter 4](#)). One solution could be to wait until the end of training, then run the whole training set through the neural network, and compute the mean and standard deviation of each input of the BN layer. These “final” input means and standard deviations can then be used instead of the batch input means and standard deviations when making predictions. However, it is often preferred to estimate these final statistics during training using a moving average of the layer's input means and standard deviations. To sum up, four parameter vectors are learned in each batch-normalized layer: $\boldsymbol{\gamma}$ (the output scale vector) and $\boldsymbol{\beta}$ (the output offset vector) are learned through regular backpropagation, and $\boldsymbol{\mu}$ (the final input mean vector), and $\boldsymbol{\sigma}$ (the final input standard deviation vector) are estimated using an exponential moving average. Note that $\boldsymbol{\mu}$ and $\boldsymbol{\sigma}$ are estimated during training, but they are not used at all during training, only after training (to replace the batch input means and standard deviations in [Equation 11-3](#)).

The authors demonstrated that this technique considerably improved all the deep neural networks they experimented with, leading to a huge improvement in the ImageNet classification task (ImageNet is a large database of images classified into many classes and commonly used to evaluate computer vision systems). The vanish-

ing gradients problem was strongly reduced, to the point that they could use saturating activation functions such as the tanh and even the logistic activation function. The networks were also much less sensitive to the weight initialization. They were able to use much larger learning rates, significantly speeding up the learning process. Specifically, they note that “Applied to a state-of-the-art image classification model, Batch Normalization achieves the same accuracy with 14 times fewer training steps, and beats the original model by a significant margin. [...] Using an ensemble of batch-normalized networks, we improve upon the best published result on ImageNet classification: reaching 4.9% top-5 validation error (and 4.8% test error), exceeding the accuracy of human raters.” Finally, like a gift that keeps on giving, Batch Normalization also acts like a regularizer, reducing the need for other regularization techniques (such as dropout, described later in this chapter).

Batch Normalization does, however, add some complexity to the model (although it can remove the need for normalizing the input data, as we discussed earlier). Moreover, there is a runtime penalty: the neural network makes slower predictions due to the extra computations required at each layer. So if you need predictions to be lightning-fast, you may want to check how well plain ELU + He initialization perform before playing with Batch Normalization.



You may find that training is rather slow, because each epoch takes much more time when you use batch normalization. However, this is usually counterbalanced by the fact that convergence is much faster with BN, so it will take fewer epochs to reach the same performance. All in all, *wall time* will usually be smaller (this is the time measured by the clock on your wall).

Implementing Batch Normalization with Keras

As with most things with Keras, implementing Batch Normalization is quite simple. Just add a `BatchNormalization` layer before or after each hidden layer’s activation function, and optionally add a BN layer as well as the first layer in your model. For example, this model applies BN after every hidden layer and as the first layer in the model (after flattening the input images):

```
model = keras.models.Sequential([
    keras.layers.Flatten(input_shape=[28, 28]),
    keras.layers.BatchNormalization(),
    keras.layers.Dense(300, activation="elu", kernel_initializer="he_normal"),
    keras.layers.BatchNormalization(),
    keras.layers.Dense(100, activation="elu", kernel_initializer="he_normal"),
    keras.layers.BatchNormalization(),
    keras.layers.Dense(10, activation="softmax")
])
```

That's all! In this tiny example with just two hidden layers, it's unlikely that Batch Normalization will have a very positive impact, but for deeper networks it can make a tremendous difference.

Let's zoom in a bit. If you display the model summary, you can see that each BN layer adds 4 parameters per input: γ , β , μ and σ (for example, the first BN layer adds 3136 parameters, which is 4 times 784). The last two parameters, μ and σ , are the moving averages, they are not affected by backpropagation, so Keras calls them “Non-trainable”⁹ (if you count the total number of BN parameters, 3136 + 1200 + 400, and divide by two, you get 2,368, which is the total number of non-trainable params in this model).

```
>>> model.summary()
Model: "sequential_3"
```

Layer (type)	Output Shape	Param #
flatten_3 (Flatten)	(None, 784)	0
batch_normalization_v2 (Batch Normalization)	(None, 784)	3136
dense_50 (Dense)	(None, 300)	235500
batch_normalization_v2_1 (Batch Normalization)	(None, 300)	1200
dense_51 (Dense)	(None, 100)	30100
batch_normalization_v2_2 (Batch Normalization)	(None, 100)	400
dense_52 (Dense)	(None, 10)	1010

```

Total params: 271,346
Trainable params: 268,978
Non-trainable params: 2,368
```

Let's look at the parameters of the first BN layer. Two are trainable (by backprop), and two are not:

```
>>> [(var.name, var.trainable) for var in model.layers[1].variables]
[('batch_normalization_v2/gamma:0', True),
 ('batch_normalization_v2/beta:0', True),
 ('batch_normalization_v2/moving_mean:0', False),
 ('batch_normalization_v2/moving_variance:0', False)]
```

Now when you create a BN layer in Keras, it also creates two operations that will be called by Keras at each iteration during training. These operations will update the

⁹ However, they are estimated during training, based on the training data, so arguably they *are* trainable. In Keras, “Non-trainable” really means “untouched by backpropagation”.

moving averages. Since we are using the TensorFlow backend, these operations are TensorFlow operations (we will discuss TF operations in [Chapter 12](#)).

```
>>> model.layers[1].updates
[<tf.Operation 'cond_2/Identity' type=Identity>,
 <tf.Operation 'cond_3/Identity' type=Identity>]
```

The authors of the BN paper argued in favor of adding the BN layers before the activation functions, rather than after (as we just did). There is some debate about this, as it seems to depend on the task. So that's one more thing you can experiment with to see which option works best on your dataset. To add the BN layers before the activation functions, we must remove the activation function from the hidden layers, and add them as separate layers after the BN layers. Moreover, since a Batch Normalization layer includes one offset parameter per input, you can remove the bias term from the previous layer (just pass `use_bias=False` when creating it):

```
model = keras.models.Sequential([
    keras.layers.Flatten(input_shape=[28, 28]),
    keras.layers.BatchNormalization(),
    keras.layers.Dense(300, kernel_initializer="he_normal", use_bias=False),
    keras.layers.BatchNormalization(),
    keras.layers.Activation("elu"),
    keras.layers.Dense(100, kernel_initializer="he_normal", use_bias=False),
    keras.layers.Activation("elu"),
    keras.layers.BatchNormalization(),
    keras.layers.Dense(10, activation="softmax")
])
```

The `BatchNormalization` class has quite a few hyperparameters you can tweak. The defaults will usually be fine, but you may occasionally need to tweak the `momentum`. This hyperparameter is used when updating the exponential moving averages: given a new value \mathbf{v} (i.e., a new vector of input means or standard deviations computed over the current batch), the running average $\hat{\mathbf{v}}$ is updated using the following equation:

$$\hat{\mathbf{v}} \leftarrow \hat{\mathbf{v}} \times \text{momentum} + \mathbf{v} \times (1 - \text{momentum})$$

A good momentum value is typically close to 1—for example, 0.9, 0.99, or 0.999 (you want more 9s for larger datasets and smaller mini-batches).

Another important hyperparameter is `axis`: it determines which axis should be normalized. It defaults to `-1`, meaning that by default it will normalize the last axis (using the means and standard deviations computed across the *other* axes). For example, when the input batch is 2D (i.e., the batch shape is [batch size, features]), this means that each input feature will be normalized based on the mean and standard deviation computed across all the instances in the batch. For example, the first BN layer in the previous code example will independently normalize (and rescale and shift) each of the 784 input features. However, if we move the first BN layer before the `Flatten`

layer, then the input batches will be 3D, with shape [batch size, height, width], therefore the BN layer will compute 28 means and 28 standard deviations (one per column of pixels, computed across all instances in the batch, and all rows in the column), and it will normalize all pixels in a given column using the same mean and standard deviation. There will also be just 28 scale parameters and 28 shift parameters. If instead you still want to treat each of the 784 pixels independently, then you should set `axis=[1, 2]`.

Notice that the BN layer does not perform the same computation during training and after training: it uses batch statistics during training, and the “final” statistics after training (i.e., the final value of the moving averages). Let’s take a peek at the source code of this class to see how this is handled:

```
class BatchNormalization(Layer):
    [...]
    def call(self, inputs, training=None):
        if training is None:
            training = keras.backend.learning_phase()
        [...]
```

The `call()` method is the one that actually performs the computations, and as you can see it has an extra `training` argument: if it is `None` it falls back to `keras.backend.learning_phase()`, which returns 1 during training (the `fit()` method ensures that). Otherwise, it returns 0. If you ever need to write a custom layer, and it needs to behave differently during training and testing, simply use the same pattern (we will discuss custom layers in [Chapter 12](#)).

Batch Normalization has become one of the most used layers in deep neural networks, to the point that it is often omitted in the diagrams, as it is assumed that BN is added after every layer. However, a very recent [paper](#)¹⁰ by Hongyi Zhang et al. may well change this: the authors show that by using a novel fixed-update (fixup) weight initialization technique, they manage to train a very deep neural network (10,000 layers!) without BN, achieving state-of-the-art performance on complex image classification tasks.

Gradient Clipping

Another popular technique to lessen the exploding gradients problem is to simply clip the gradients during backpropagation so that they never exceed some threshold. This is called *Gradient Clipping*.¹¹ This technique is most often used in recurrent neu-

10 “Fixup Initialization: Residual Learning Without Normalization,” Hongyi Zhang, Yann N. Dauphin, Tengyu Ma (2019).

11 “On the difficulty of training recurrent neural networks,” R. Pascanu et al. (2013).

ral networks, as Batch Normalization is tricky to use in RNNs, as we will see in ????. For other types of networks, BN is usually sufficient.

In Keras, implementing Gradient Clipping is just a matter of setting the `clipvalue` or `clipnorm` argument when creating an optimizer. For example:

```
optimizer = keras.optimizers.SGD(clipvalue=1.0)
model.compile(loss="mse", optimizer=optimizer)
```

This will clip every component of the gradient vector to a value between -1.0 and 1.0 . This means that all the partial derivatives of the loss (with regards to each and every trainable parameter) will be clipped between -1.0 and 1.0 . The threshold is a hyperparameter you can tune. Note that it may change the orientation of the gradient vector: for example, if the original gradient vector is $[0.9, 100.0]$, it points mostly in the direction of the second axis, but once you clip it by value, you get $[0.9, 1.0]$, which points roughly in the diagonal between the two axes. In practice however, this approach works well. If you want to ensure that Gradient Clipping does not change the direction of the gradient vector, you should clip by norm by setting `clipnorm` instead of `clipvalue`. This will clip the whole gradient if its ℓ_2 norm is greater than the threshold you picked. For example, if you set `clipnorm=1.0`, then the vector $[0.9, 100.0]$ will be clipped to $[0.00899964, 0.9999595]$, preserving its orientation, but almost eliminating the first component. If you observe that the gradients explode during training (you can track the size of the gradients using TensorBoard), you may want to try both clipping by value and clipping by norm, with different threshold, and see which option performs best on the validation set.

Reusing Pretrained Layers

It is generally not a good idea to train a very large DNN from scratch: instead, you should always try to find an existing neural network that accomplishes a similar task to the one you are trying to tackle (we will discuss how to find them in [Chapter 14](#)), then just reuse the lower layers of this network: this is called *transfer learning*. It will not only speed up training considerably, but will also require much less training data.

For example, suppose that you have access to a DNN that was trained to classify pictures into 100 different categories, including animals, plants, vehicles, and everyday objects. You now want to train a DNN to classify specific types of vehicles. These tasks are very similar, even partly overlapping, so you should try to reuse parts of the first network (see [Figure 11-4](#)).

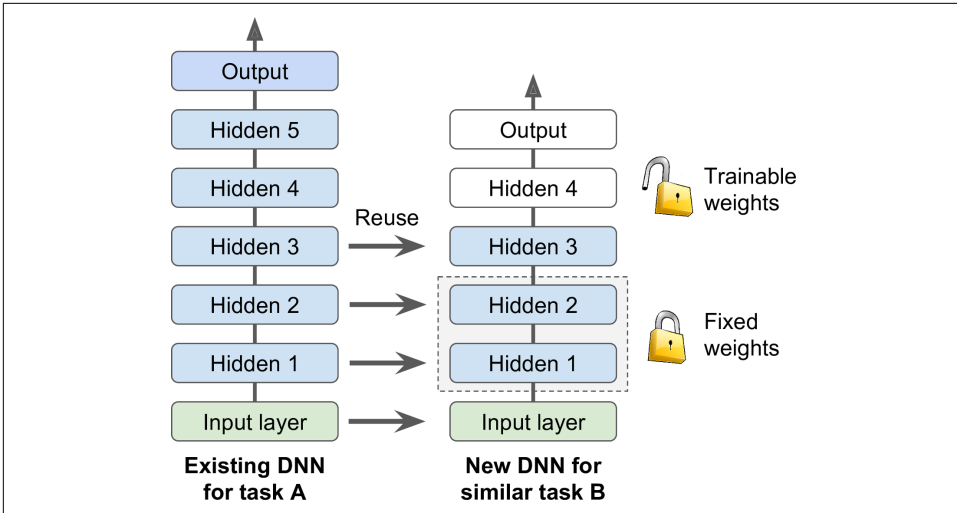

Figure 11-4. Reusing pretrained layers



If the input pictures of your new task don't have the same size as the ones used in the original task, you will usually have to add a preprocessing step to resize them to the size expected by the original model. More generally, transfer learning will work best when the inputs have similar low-level features.

The output layer of the original model should usually be replaced since it is most likely not useful at all for the new task, and it may not even have the right number of outputs for the new task.

Similarly, the upper hidden layers of the original model are less likely to be as useful as the lower layers, since the high-level features that are most useful for the new task may differ significantly from the ones that were most useful for the original task. You want to find the right number of layers to reuse.



The more similar the tasks are, the more layers you want to reuse (starting with the lower layers). For very similar tasks, you can try keeping all the hidden layers and just replace the output layer.

Try freezing all the reused layers first (i.e., make their weights non-trainable, so gradient descent won't modify them), then train your model and see how it performs. Then try unfreezing one or two of the top hidden layers to let backpropagation tweak them and see if performance improves. The more training data you have, the more

layers you can unfreeze. It is also useful to reduce the learning rate when you unfreeze reused layers: this will avoid wrecking their fine-tuned weights.

If you still cannot get good performance, and you have little training data, try dropping the top hidden layer(s) and freeze all remaining hidden layers again. You can iterate until you find the right number of layers to reuse. If you have plenty of training data, you may try replacing the top hidden layers instead of dropping them, and even add more hidden layers.

Transfer Learning With Keras

Let's look at an example. Suppose the fashion MNIST dataset only contained 8 classes, for example all classes except for sandals and shirts. Someone built and trained a Keras model on that set and got reasonably good performance (>90% accuracy). Let's call this model A. You now want to tackle a different task: you have images of sandals and shirts, and you want to train a binary classifier (positive=shirts, negative=sandals). However, your dataset is quite small, you only have 200 labeled images. When you train a new model for this task (let's call it model B), with the same architecture as model A, it performs reasonably well (97.2% accuracy), but since it's a much easier task (there are just 2 classes), you were hoping for more. While drinking your morning coffee, you realize that your task is quite similar to task A, so perhaps transfer learning can help? Let's find out!

First, you need to load model A, and create a new model based on the model A's layers. Let's reuse all layers except for the output layer:

```
model_A = keras.models.load_model("my_model_A.h5")
model_B_on_A = keras.models.Sequential(model_A.layers[:-1])
model_B_on_A.add(keras.layers.Dense(1, activation="sigmoid"))
```

Note that `model_A` and `model_B_on_A` now share some layers. When you train `model_B_on_A`, it will also affect `model_A`. If you want to avoid that, you need to clone `model_A` before you reuse its layers. To do this, you must clone model A's architecture, then copy its weights (since `clone_model()` does not clone the weights):

```
model_A_clone = keras.models.clone_model(model_A)
model_A_clone.set_weights(model_A.get_weights())
```

Now we could just train `model_B_on_A` for task B, but since the new output layer was initialized randomly, it will make large errors, at least during the first few epochs, so there will be large error gradients that may wreck the reused weights. To avoid this, one approach is to freeze the reused layers during the first few epochs, giving the new layer some time to learn reasonable weights. To do this, simply set every layer's `trainable` attribute to `False` and compile the model:

```
for layer in model_B_on_A.layers[:-1]:
    layer.trainable = False
```

```
model_B_on_A.compile(loss="binary_crossentropy", optimizer="sgd",  
                    metrics=["accuracy"])
```



You must always compile your model after you freeze or unfreeze layers.

Next, we can train the model for a few epochs, then unfreeze the reused layers (which requires compiling the model again) and continue training to fine-tune the reused layers for task B. After unfreezing the reused layers, it is usually a good idea to reduce the learning rate, once again to avoid damaging the reused weights:

```
history = model_B_on_A.fit(X_train_B, y_train_B, epochs=4,  
                          validation_data=(X_valid_B, y_valid_B))  
  
for layer in model_B_on_A.layers[:-1]:  
    layer.trainable = True  
  
optimizer = keras.optimizers.SGD(lr=1e-4) # the default lr is 1e-3  
model_B_on_A.compile(loss="binary_crossentropy", optimizer=optimizer,  
                    metrics=["accuracy"])  
history = model_B_on_A.fit(X_train_B, y_train_B, epochs=16,  
                          validation_data=(X_valid_B, y_valid_B))
```

So, what's the final verdict? Well this model's test accuracy is 99.25%, which means that transfer learning reduced the error rate from 2.8% down to almost 0.7%! That's a factor of 4!

```
>>> model_B_on_A.evaluate(X_test_B, y_test_B)  
[0.06887910133600235, 0.9925]
```

Are you convinced? Well you shouldn't be: I cheated! :) I tried many configurations until I found one that demonstrated a strong improvement. If you try to change the classes or the random seed, you will see that the improvement generally drops, or even vanishes or reverses. What I did is called "torturing the data until it confesses". When a paper just looks too positive, you should be suspicious: perhaps the flashy new technique does not help much (in fact, it may even degrade performance), but the authors tried many variants and reported only the best results (which may be due to sheer luck), without mentioning how many failures they encountered on the way. Most of the time, this is not malicious at all, but it is part of the reason why so many results in Science can never be reproduced.

So why did I cheat? Well it turns out that transfer learning does not work very well with small dense networks: it works best with deep convolutional neural networks, so we will revisit transfer learning in [Chapter 14](#), using the same techniques (and this time there will be no cheating, I promise!).

Unsupervised Pretraining

Suppose you want to tackle a complex task for which you don't have much labeled training data, but unfortunately you cannot find a model trained on a similar task. Don't lose all hope! First, you should of course try to gather more labeled training data, but if this is too hard or too expensive, you may still be able to perform *unsupervised pretraining* (see [Figure 11-5](#)). It is often rather cheap to gather unlabeled training examples, but quite expensive to label them. If you can gather plenty of unlabeled training data, you can try to train the layers one by one, starting with the lowest layer and then going up, using an unsupervised feature detector algorithm such as *Restricted Boltzmann Machines* (RBMs; see [???](#)) or autoencoders (see [???](#)). Each layer is trained on the output of the previously trained layers (all layers except the one being trained are frozen). Once all layers have been trained this way, you can add the output layer for your task, and fine-tune the final network using supervised learning (i.e., with the labeled training examples). At this point, you can unfreeze all the pretrained layers, or just some of the pretrained layers, or just some of the pretraining ones.

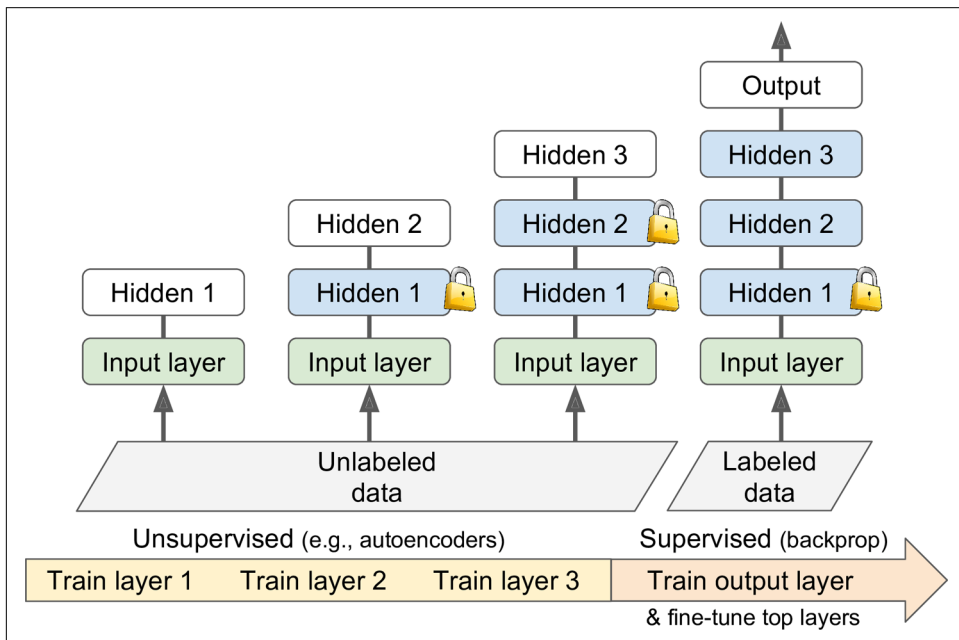

Figure 11-5. Unsupervised pretraining

This is a rather long and tedious process, but it often works well; in fact, it is this technique that Geoffrey Hinton and his team used in 2006 and which led to the revival of neural networks and the success of Deep Learning. Until 2010, unsupervised pretraining (typically using RBMs) was the norm for deep nets, and it was only after the vanishing gradients problem was alleviated that it became much more com-

mon to train DNNs purely using supervised learning. However, unsupervised pre-training (today typically using autoencoders rather than RBMs) is still a good option when you have a complex task to solve, no similar model you can reuse, and little labeled training data but plenty of unlabeled training data.

Pretraining on an Auxiliary Task

If you do not have much labeled training data, one last option is to train a first neural network on an auxiliary task for which you can easily obtain or generate labeled training data, then reuse the lower layers of that network for your actual task. The first neural network's lower layers will learn feature detectors that will likely be reusable by the second neural network.

For example, if you want to build a system to recognize faces, you may only have a few pictures of each individual—clearly not enough to train a good classifier. Gathering hundreds of pictures of each person would not be practical. However, you could gather a lot of pictures of random people on the web and train a first neural network to detect whether or not two different pictures feature the same person. Such a network would learn good feature detectors for faces, so reusing its lower layers would allow you to train a good face classifier using little training data.

For *natural language processing* (NLP) applications, you can easily download millions of text documents and automatically generate labeled data from it. For example, you could randomly mask out some words and train a model to predict what the missing words are (e.g., it should predict that the missing word in the sentence “What ___ you saying?” is probably “are” or “were”). If you can train a model to reach good performance on this task, then it will already know quite a lot about language, and you can certainly reuse it for your actual task, and fine-tune it on your labeled data (we will discuss more pretraining tasks in ???).



Self-supervised learning is when you automatically generate the labels from the data itself, then you train a model on the resulting “labeled” dataset using supervised learning techniques. Since this approach requires no human labeling whatsoever, it is best classified as a form of unsupervised learning.

Faster Optimizers

Training a very large deep neural network can be painfully slow. So far we have seen four ways to speed up training (and reach a better solution): applying a good initialization strategy for the connection weights, using a good activation function, using Batch Normalization, and reusing parts of a pretrained network (possibly built on an auxiliary task or using unsupervised learning). Another huge speed boost comes from using a faster optimizer than the regular Gradient Descent optimizer. In this section

we will present the most popular ones: Momentum optimization, Nesterov Accelerated Gradient, AdaGrad, RMSProp, and finally Adam and Nadam optimization.

Momentum Optimization

Imagine a bowling ball rolling down a gentle slope on a smooth surface: it will start out slowly, but it will quickly pick up momentum until it eventually reaches terminal velocity (if there is some friction or air resistance). This is the very simple idea behind *Momentum optimization*, proposed by Boris Polyak in 1964.¹² In contrast, regular Gradient Descent will simply take small regular steps down the slope, so it will take much more time to reach the bottom.

Recall that Gradient Descent simply updates the weights θ by directly subtracting the gradient of the cost function $J(\theta)$ with regards to the weights ($\nabla_{\theta}J(\theta)$) multiplied by the learning rate η . The equation is: $\theta \leftarrow \theta - \eta \nabla_{\theta}J(\theta)$. It does not care about what the earlier gradients were. If the local gradient is tiny, it goes very slowly.

Momentum optimization cares a great deal about what previous gradients were: at each iteration, it subtracts the local gradient from the *momentum vector* \mathbf{m} (multiplied by the learning rate η), and it updates the weights by simply adding this momentum vector (see Equation 11-4). In other words, the gradient is used for acceleration, not for speed. To simulate some sort of friction mechanism and prevent the momentum from growing too large, the algorithm introduces a new hyperparameter β , simply called the *momentum*, which must be set between 0 (high friction) and 1 (no friction). A typical momentum value is 0.9.

Equation 11-4. Momentum algorithm

1. $\mathbf{m} \leftarrow \beta \mathbf{m} - \eta \nabla_{\theta}J(\theta)$
2. $\theta \leftarrow \theta + \mathbf{m}$

You can easily verify that if the gradient remains constant, the terminal velocity (i.e., the maximum size of the weight updates) is equal to that gradient multiplied by the learning rate η multiplied by $\frac{1}{1-\beta}$ (ignoring the sign). For example, if $\beta = 0.9$, then the terminal velocity is equal to 10 times the gradient times the learning rate, so Momentum optimization ends up going 10 times faster than Gradient Descent! This allows Momentum optimization to escape from plateaus much faster than Gradient Descent. In particular, we saw in Chapter 4 that when the inputs have very different scales the cost function will look like an elongated bowl (see Figure 4-7). Gradient Descent goes down the steep slope quite fast, but then it takes a very long time to go down the val-

¹² “Some methods of speeding up the convergence of iteration methods,” B. Polyak (1964).

ley. In contrast, Momentum optimization will roll down the valley faster and faster until it reaches the bottom (the optimum). In deep neural networks that don't use Batch Normalization, the upper layers will often end up having inputs with very different scales, so using Momentum optimization helps a lot. It can also help roll past local optima.



Due to the momentum, the optimizer may overshoot a bit, then come back, overshoot again, and oscillate like this many times before stabilizing at the minimum. This is one of the reasons why it is good to have a bit of friction in the system: it gets rid of these oscillations and thus speeds up convergence.

Implementing Momentum optimization in Keras is a no-brainer: just use the SGD optimizer and set its `momentum` hyperparameter, then lie back and profit!

```
optimizer = keras.optimizers.SGD(lr=0.001, momentum=0.9)
```

The one drawback of Momentum optimization is that it adds yet another hyperparameter to tune. However, the momentum value of 0.9 usually works well in practice and almost always goes faster than regular Gradient Descent.

Nesterov Accelerated Gradient

One small variant to Momentum optimization, proposed by [Yurii Nesterov in 1983](#),¹³ is almost always faster than vanilla Momentum optimization. The idea of *Nesterov Momentum optimization*, or *Nesterov Accelerated Gradient* (NAG), is to measure the gradient of the cost function not at the local position but slightly ahead in the direction of the momentum (see [Equation 11-5](#)). The only difference from vanilla Momentum optimization is that the gradient is measured at $\theta + \beta\mathbf{m}$ rather than at θ .

Equation 11-5. Nesterov Accelerated Gradient algorithm

1. $\mathbf{m} \leftarrow \beta\mathbf{m} - \eta\nabla_{\theta}J(\theta + \beta\mathbf{m})$
2. $\theta \leftarrow \theta + \mathbf{m}$

This small tweak works because in general the momentum vector will be pointing in the right direction (i.e., toward the optimum), so it will be slightly more accurate to use the gradient measured a bit farther in that direction rather than using the gradient at the original position, as you can see in [Figure 11-6](#) (where ∇_1 represents the gradient of the cost function measured at the starting point θ , and ∇_2 represents the

¹³ "A Method for Unconstrained Convex Minimization Problem with the Rate of Convergence $O(1/k^2)$," Yurii Nesterov (1983).

gradient at the point located at $\theta + \beta\mathbf{m}$). As you can see, the Nesterov update ends up slightly closer to the optimum. After a while, these small improvements add up and NAG ends up being significantly faster than regular Momentum optimization. Moreover, note that when the momentum pushes the weights across a valley, ∇_1 continues to push further across the valley, while ∇_2 pushes back toward the bottom of the valley. This helps reduce oscillations and thus converges faster.

NAG will almost always speed up training compared to regular Momentum optimization. To use it, simply set `nesterov=True` when creating the SGD optimizer:

```
optimizer = keras.optimizers.SGD(lr=0.001, momentum=0.9, nesterov=True)
```

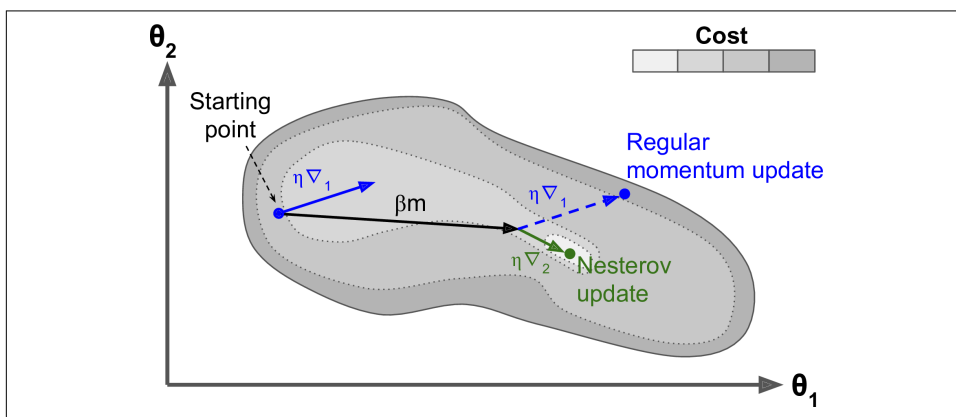

Figure 11-6. Regular versus Nesterov Momentum optimization

AdaGrad

Consider the elongated bowl problem again: Gradient Descent starts by quickly going down the steepest slope, then slowly goes down the bottom of the valley. It would be nice if the algorithm could detect this early on and correct its direction to point a bit more toward the global optimum.

The *AdaGrad algorithm*¹⁴ achieves this by scaling down the gradient vector along the steepest dimensions (see Equation 11-6):

Equation 11-6. AdaGrad algorithm

1. $\mathbf{s} \leftarrow \mathbf{s} + \nabla_{\theta} J(\theta) \otimes \nabla_{\theta} J(\theta)$
2. $\theta \leftarrow \theta - \eta \nabla_{\theta} J(\theta) \oslash \sqrt{\mathbf{s} + \epsilon}$

¹⁴ “Adaptive Subgradient Methods for Online Learning and Stochastic Optimization,” J. Duchi et al. (2011).

The first step accumulates the square of the gradients into the vector \mathbf{s} (recall that the \otimes symbol represents the element-wise multiplication). This vectorized form is equivalent to computing $s_i \leftarrow s_i + (\partial J(\boldsymbol{\theta}) / \partial \theta_i)^2$ for each element s_i of the vector \mathbf{s} ; in other words, each s_i accumulates the squares of the partial derivative of the cost function with regards to parameter θ_i . If the cost function is steep along the i^{th} dimension, then s_i will get larger and larger at each iteration.

The second step is almost identical to Gradient Descent, but with one big difference: the gradient vector is scaled down by a factor of $\sqrt{s_i + \epsilon}$ (the \oslash symbol represents the element-wise division, and ϵ is a smoothing term to avoid division by zero, typically set to 10^{-10}). This vectorized form is equivalent to computing $\theta_i \leftarrow \theta_i - \eta \partial J(\boldsymbol{\theta}) / \partial \theta_i / \sqrt{s_i + \epsilon}$ for all parameters θ_i (simultaneously).

In short, this algorithm decays the learning rate, but it does so faster for steep dimensions than for dimensions with gentler slopes. This is called an *adaptive learning rate*. It helps point the resulting updates more directly toward the global optimum (see [Figure 11-7](#)). One additional benefit is that it requires much less tuning of the learning rate hyperparameter η .

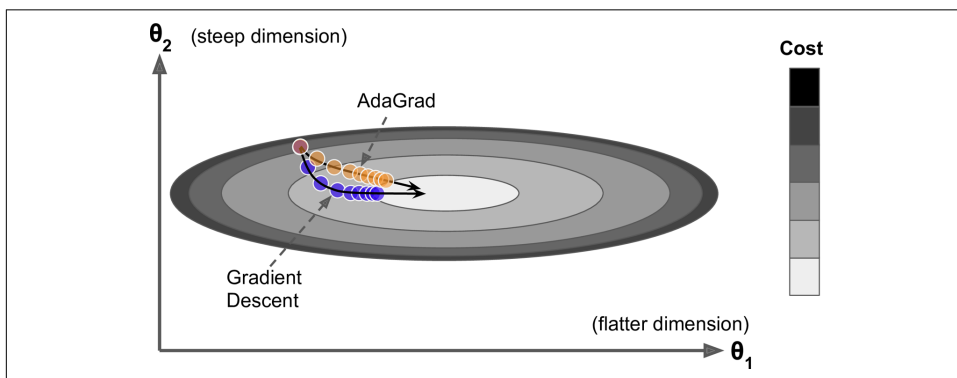

Figure 11-7. *AdaGrad versus Gradient Descent*

AdaGrad often performs well for simple quadratic problems, but unfortunately it often stops too early when training neural networks. The learning rate gets scaled down so much that the algorithm ends up stopping entirely before reaching the global optimum. So even though Keras has an Adagrad optimizer, you should not use it to train deep neural networks (it may be efficient for simpler tasks such as Linear Regression, though). However, understanding Adagrad is helpful to grasp the other adaptive learning rate optimizers.

RMSProp

Although AdaGrad slows down a bit too fast and ends up never converging to the global optimum, the *RMSProp* algorithm¹⁵ fixes this by accumulating only the gradients from the most recent iterations (as opposed to all the gradients since the beginning of training). It does so by using exponential decay in the first step (see [Equation 11-7](#)).

Equation 11-7. RMSProp algorithm

1. $\mathbf{s} \leftarrow \beta \mathbf{s} + (1 - \beta) \nabla_{\theta} J(\theta) \otimes \nabla_{\theta} J(\theta)$
2. $\theta \leftarrow \theta - \eta \nabla_{\theta} J(\theta) \oslash \sqrt{\mathbf{s} + \epsilon}$

The decay rate β is typically set to 0.9. Yes, it is once again a new hyperparameter, but this default value often works well, so you may not need to tune it at all.

As you might expect, Keras has an RMSProp optimizer:

```
optimizer = keras.optimizers.RMSprop(lr=0.001, rho=0.9)
```

Except on very simple problems, this optimizer almost always performs much better than AdaGrad. In fact, it was the preferred optimization algorithm of many researchers until Adam optimization came around.

Adam and Nadam Optimization

Adam,¹⁶ which stands for *adaptive moment estimation*, combines the ideas of Momentum optimization and RMSProp: just like Momentum optimization it keeps track of an exponentially decaying average of past gradients, and just like RMSProp it keeps track of an exponentially decaying average of past squared gradients (see [Equation 11-8](#)).¹⁷

¹⁵ This algorithm was created by Geoffrey Hinton and Tijmen Tieleman in 2012, and presented by Geoffrey Hinton in his Coursera class on neural networks (slides: <https://homl.info/57>; video: <https://homl.info/58>). Amusingly, since the authors did not write a paper to describe it, researchers often cite “slide 29 in lecture 6” in their papers.

¹⁶ “Adam: A Method for Stochastic Optimization,” D. Kingma, J. Ba (2015).

¹⁷ These are estimations of the mean and (uncentered) variance of the gradients. The mean is often called the *first moment*, while the variance is often called the *second moment*, hence the name of the algorithm.

Equation 11-8. Adam algorithm

1. $\mathbf{m} \leftarrow \beta_1 \mathbf{m} + (1 - \beta_1) \nabla_{\boldsymbol{\theta}} J(\boldsymbol{\theta})$
2. $\mathbf{s} \leftarrow \beta_2 \mathbf{s} + (1 - \beta_2) \nabla_{\boldsymbol{\theta}} J(\boldsymbol{\theta}) \otimes \nabla_{\boldsymbol{\theta}} J(\boldsymbol{\theta})$
3. $\widehat{\mathbf{m}} \leftarrow \frac{\mathbf{m}}{1 - \beta_1^t}$
4. $\widehat{\mathbf{s}} \leftarrow \frac{\mathbf{s}}{1 - \beta_2^t}$
5. $\boldsymbol{\theta} \leftarrow \boldsymbol{\theta} + \eta \widehat{\mathbf{m}} \oslash \sqrt{\widehat{\mathbf{s}} + \epsilon}$

- t represents the iteration number (starting at 1).

If you just look at steps 1, 2, and 5, you will notice Adam's close similarity to both Momentum optimization and RMSProp. The only difference is that step 1 computes an exponentially decaying average rather than an exponentially decaying sum, but these are actually equivalent except for a constant factor (the decaying average is just $1 - \beta_1$ times the decaying sum). Steps 3 and 4 are somewhat of a technical detail: since \mathbf{m} and \mathbf{s} are initialized at 0, they will be biased toward 0 at the beginning of training, so these two steps will help boost \mathbf{m} and \mathbf{s} at the beginning of training.

The momentum decay hyperparameter β_1 is typically initialized to 0.9, while the scaling decay hyperparameter β_2 is often initialized to 0.999. As earlier, the smoothing term ϵ is usually initialized to a tiny number such as 10^{-7} . These are the default values for the Adam class (to be precise, epsilon defaults to None, which tells Keras to use `keras.backend.epsilon()`, which defaults to 10^{-7} ; you can change it using `keras.backend.set_epsilon()`).

```
optimizer = keras.optimizers.Adam(lr=0.001, beta_1=0.9, beta_2=0.999)
```

Since Adam is an adaptive learning rate algorithm (like AdaGrad and RMSProp), it requires less tuning of the learning rate hyperparameter η . You can often use the default value $\eta = 0.001$, making Adam even easier to use than Gradient Descent.



If you are starting to feel overwhelmed by all these different techniques, and wondering how to choose the right ones for your task, don't worry: some practical guidelines are provided at the end of this chapter.

Finally, two variants of Adam are worth mentioning:

- Adamax, introduced in the same paper as Adam: notice that in step 2 of [Equation 11-8](#), Adam accumulates the squares of the gradients in \mathbf{s} (with a greater weight for more recent weights). In step 5, if we ignore ϵ and steps 3 and 4 (which are technical details anyway), Adam just scales down the parameter updates by the square root of \mathbf{s} . In short, Adam scales down the parameter updates by the ℓ_2 norm of the time-decayed gradients (recall that the ℓ_2 norm is the square root of the sum of squares). Adamax just replaces the ℓ_2 norm with the ℓ_∞ norm (a fancy way of saying the max). Specifically, it replaces step 2 in [Equation 11-8](#) with $\mathbf{s} \leftarrow \max(\beta_2 \mathbf{s}, \nabla_\theta J(\theta))$, it drops step 4, and in step 5 it scales down the gradient updates by a factor of \mathbf{s} , which is just the max of the time-decayed gradients. In practice, this can make Adamax more stable than Adam, but this really depends on the dataset, and in general Adam actually performs better. So it's just one more optimizer you can try if you experience problems with Adam on some task.
- **Nadam optimization**¹⁸ is more important: it is simply Adam optimization plus the Nesterov trick, so it will often converge slightly faster than Adam. In his report, Timothy Dozat compares many different optimizers on various tasks, and finds that Nadam generally outperforms Adam, but is sometimes outperformed by RMSProp.



Adaptive optimization methods (including RMSProp, Adam and Nadam optimization) are often great, converging fast to a good solution. However, a [2017 paper](#)¹⁹ by Ashia C. Wilson et al. showed that they can lead to solutions that generalize poorly on some datasets. So when you are disappointed by your model's performance, try using plain Nesterov Accelerated Gradient instead: your dataset may just be allergic to adaptive gradients. Also check out the latest research, it is moving fast (e.g., AdaBound).

All the optimization techniques discussed so far only rely on the *first-order partial derivatives (Jacobians)*. The optimization literature contains amazing algorithms based on the *second-order partial derivatives* (the *Hessians*, which are the partial derivatives of the Jacobians). Unfortunately, these algorithms are very hard to apply to deep neural networks because there are n^2 Hessians per output (where n is the number of parameters), as opposed to just n Jacobians per output. Since DNNs typically have tens of thousands of parameters, the second-order optimization algorithms

¹⁸ "Incorporating Nesterov Momentum into Adam," Timothy Dozat (2015).

¹⁹ "The Marginal Value of Adaptive Gradient Methods in Machine Learning," A. C. Wilson et al. (2017).

often don't even fit in memory, and even when they do, computing the Hessians is just too slow.

Training Sparse Models

All the optimization algorithms just presented produce dense models, meaning that most parameters will be nonzero. If you need a blazingly fast model at runtime, or if you need it to take up less memory, you may prefer to end up with a sparse model instead.

One trivial way to achieve this is to train the model as usual, then get rid of the tiny weights (set them to 0). However, this will typically not lead to a very sparse model, and it may degrade the model's performance.

A better option is to apply strong ℓ_1 regularization during training, as it pushes the optimizer to zero out as many weights as it can (as discussed in [Chapter 4](#) about Lasso Regression).

However, in some cases these techniques may remain insufficient. One last option is to apply *Dual Averaging*, often called *Follow The Regularized Leader* (FTRL), a [technique proposed by Yurii Nesterov](#).²⁰ When used with ℓ_1 regularization, this technique often leads to very sparse models. Keras implements a variant of FTRL called *FTRL-Proximal*²¹ in the FTRL optimizer.

Learning Rate Scheduling

Finding a good learning rate can be tricky. If you set it way too high, training may actually diverge (as we discussed in [Chapter 4](#)). If you set it too low, training will eventually converge to the optimum, but it will take a very long time. If you set it slightly too high, it will make progress very quickly at first, but it will end up dancing around the optimum, never really settling down. If you have a limited computing budget, you may have to interrupt training before it has converged properly, yielding a suboptimal solution (see [Figure 11-8](#)).

²⁰ "Primal-Dual Subgradient Methods for Convex Problems," Yurii Nesterov (2005).

²¹ "Ad Click Prediction: a View from the Trenches," H. McMahan et al. (2013).

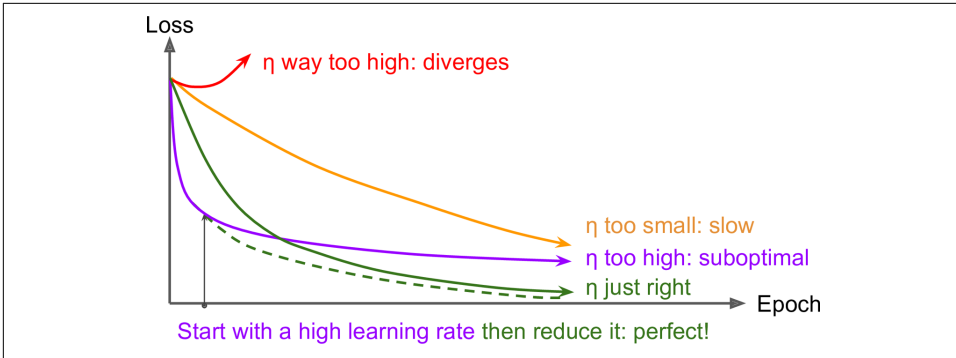

Figure 11-8. Learning curves for various learning rates η

As we discussed in [Chapter 10](#), one approach is to start with a large learning rate, and divide it by 3 until the training algorithm stops diverging. You will not be too far from the optimal learning rate, which will learn quickly and converge to good solution.

However, you can do better than a constant learning rate: if you start with a high learning rate and then reduce it once it stops making fast progress, you can reach a good solution faster than with the optimal constant learning rate. There are many different strategies to reduce the learning rate during training. These strategies are called *learning schedules* (we briefly introduced this concept in [Chapter 4](#)), the most common of which are:

Power scheduling

Set the learning rate to a function of the iteration number t : $\eta(t) = \eta_0 / (1 + t/k)^c$. The initial learning rate η_0 , the power c (typically set to 1) and the steps s are hyperparameters. The learning rate drops at each step, and after s steps it is down to $\eta_0 / 2$. After s more steps, it is down to $\eta_0 / 3$. Then down to $\eta_0 / 4$, then $\eta_0 / 5$, and so on. As you can see, this schedule first drops quickly, then more and more slowly. Of course, this requires tuning η_0 , s (and possibly c).

Exponential scheduling

Set the learning rate to: $\eta(t) = \eta_0 0.1^{t/s}$. The learning rate will gradually drop by a factor of 10 every s steps. While power scheduling reduces the learning rate more and more slowly, exponential scheduling keeps slashing it by a factor of 10 every s steps.

Piecewise constant scheduling

Use a constant learning rate for a number of epochs (e.g., $\eta_0 = 0.1$ for 5 epochs), then a smaller learning rate for another number of epochs (e.g., $\eta_1 = 0.001$ for 50 epochs), and so on. Although this solution can work very well, it requires fid-

dling around to figure out the right sequence of learning rates, and how long to use each of them.

Performance scheduling

Measure the validation error every N steps (just like for early stopping) and reduce the learning rate by a factor of λ when the error stops dropping.

A 2013 paper²² by Andrew Senior et al. compared the performance of some of the most popular learning schedules when training deep neural networks for speech recognition using Momentum optimization. The authors concluded that, in this setting, both performance scheduling and exponential scheduling performed well. They favored exponential scheduling because it was easy to tune and it converged slightly faster to the optimal solution (they also mentioned that it was easier to implement than performance scheduling, but in Keras both options are easy).

Implementing power scheduling in Keras is the easiest option: just set the decay hyperparameter when creating an optimizer. The decay is the inverse of s (the number of steps it takes to divide the learning rate by one more unit), and Keras assumes that c is equal to 1. For example:

```
optimizer = keras.optimizers.SGD(lr=0.01, decay=1e-4)
```

Exponential scheduling and piecewise scheduling are quite simple too. You first need to define a function that takes the current epoch and returns the learning rate. For example, let's implement exponential scheduling:

```
def exponential_decay_fn(epoch):  
    return 0.01 * 0.1**(epoch / 20)
```

If you do not want to hard-code η_0 and s , you can create a function that returns a configured function:

```
def exponential_decay(lr0, s):  
    def exponential_decay_fn(epoch):  
        return lr0 * 0.1**(epoch / s)  
    return exponential_decay_fn  
  
exponential_decay_fn = exponential_decay(lr0=0.01, s=20)
```

Next, just create a `LearningRateScheduler` callback, giving it the schedule function, and pass this callback to the `fit()` method:

```
lr_scheduler = keras.callbacks.LearningRateScheduler(exponential_decay_fn)  
history = model.fit(X_train_scaled, y_train, [...], callbacks=[lr_scheduler])
```

²² "An Empirical Study of Learning Rates in Deep Neural Networks for Speech Recognition," A. Senior et al. (2013).

The `LearningRateScheduler` will update the optimizer's `learning_rate` attribute at the beginning of each epoch. Updating the learning rate just once per epoch is usually enough, but if you want it to be updated more often, for example at every step, you need to write your own callback (see the notebook for an example). This can make sense if there are many steps per epoch.

The schedule function can optionally take the current learning rate as a second argument. For example, the following schedule function just multiplies the previous learning rate by $0.1^{1/20}$, which results in the same exponential decay (except the decay now starts at the beginning of epoch 0 instead of 1). This implementation relies on the optimizer's initial learning rate (contrary to the previous implementation), so make sure to set it appropriately.

```
def exponential_decay_fn(epoch, lr):  
    return lr * 0.1**(1 / 20)
```

When you save a model, the optimizer and its learning rate get saved along with it. This means that with this new schedule function, you could just load a trained model and continue training where it left off, no problem. However, things are not so simple if your schedule function uses the epoch argument: indeed, the epoch does not get saved, and it gets reset to 0 every time you call the `fit()` method. This could lead to a very large learning rate when you continue training a model where it left off, which would likely damage your model's weights. One solution is to manually set the `fit()` method's `initial_epoch` argument so the epoch starts at the right value.

For piecewise constant scheduling, you can use a schedule function like the following one (as earlier, you can define a more general function if you want, see the notebook for an example), then create a `LearningRateScheduler` callback with this function and pass it to the `fit()` method, just like we did for exponential scheduling:

```
def piecewise_constant_fn(epoch):  
    if epoch < 5:  
        return 0.01  
    elif epoch < 15:  
        return 0.005  
    else:  
        return 0.001
```

For performance scheduling, simply use the `ReduceLRonPlateau` callback. For example, if you pass the following callback to the `fit()` method, it will multiply the learning rate by 0.5 whenever the best validation loss does not improve for 5 consecutive epochs (other options are available, please check the documentation for more details):

```
lr_scheduler = keras.callbacks.ReduceLRonPlateau(factor=0.5, patience=5)
```

Lastly, `tf.keras` offers an alternative way to implement learning rate scheduling: just define the learning rate using one of the schedules available in `keras.optimiz`

ers.schedules, then pass this learning rate to any optimizer. This approach updates the learning rate at each step rather than at each epoch. For example, here is how to implement the same exponential schedule as earlier:

```
s = 20 * len(X_train) // 32 # number of steps in 20 epochs (batch size = 32)
learning_rate = keras.optimizers.schedules.ExponentialDecay(0.01, s, 0.1)
optimizer = keras.optimizers.SGD(learning_rate)
```

This is nice and simple, plus when you save the model, the learning rate and its schedule (including its state) get saved as well. However, this approach is not part of the Keras API, it is specific to tf.keras.

To sum up, exponential decay or performance scheduling can considerably speed up convergence, so give them a try!

Avoiding Overfitting Through Regularization

With four parameters I can fit an elephant and with five I can make him wiggle his trunk.

—John von Neumann, *cited by Enrico Fermi in Nature 427*

With thousands of parameters you can fit the whole zoo. Deep neural networks typically have tens of thousands of parameters, sometimes even millions. With so many parameters, the network has an incredible amount of freedom and can fit a huge variety of complex datasets. But this great flexibility also means that it is prone to overfitting the training set. We need regularization.

We already implemented one of the best regularization techniques in [Chapter 10](#): early stopping. Moreover, even though Batch Normalization was designed to solve the vanishing/exploding gradients problems, is also acts like a pretty good regularizer. In this section we will present other popular regularization techniques for neural networks: ℓ_1 and ℓ_2 regularization, dropout and max-norm regularization.

ℓ_1 and ℓ_2 Regularization

Just like you did in [Chapter 4](#) for simple linear models, you can use ℓ_1 and ℓ_2 regularization to constrain a neural network's connection weights (but typically not its biases). Here is how to apply ℓ_2 regularization to a Keras layer's connection weights, using a regularization factor of 0.01:

```
layer = keras.layers.Dense(100, activation="elu",
                           kernel_initializer="he_normal",
                           kernel_regularizer=keras.regularizers.l2(0.01))
```

The `l2()` function returns a regularizer that will be called to compute the regularization loss, at each step during training. This regularization loss is then added to the final loss. As you might expect, you can just use `keras.regularizers.l1()` if you

want ℓ_1 regularization, and if you want both ℓ_1 and ℓ_2 regularization, use `keras.regularizers.l1_l2()` (specifying both regularization factors).

Since you will typically want to apply the same regularizer to all layers in your network, as well as the same activation function and the same initialization strategy in all hidden layers, you may find yourself repeating the same arguments over and over. This makes it ugly and error-prone. To avoid this, you can try refactoring your code to use loops. Another option is to use Python's `functools.partial()` function: it lets you create a thin wrapper for any callable, with some default argument values. For example:

```
from functools import partial

RegularizedDense = partial(keras.layers.Dense,
                           activation="elu",
                           kernel_initializer="he_normal",
                           kernel_regularizer=keras.regularizers.l2(0.01))

model = keras.models.Sequential([
    keras.layers.Flatten(input_shape=[28, 28]),
    RegularizedDense(300),
    RegularizedDense(100),
    RegularizedDense(10, activation="softmax",
                    kernel_initializer="glorot_uniform")
])
```

Dropout

Dropout is one of the most popular regularization techniques for deep neural networks. It was **proposed**²³ by Geoffrey Hinton in 2012 and further detailed in a **paper**²⁴ by Nitish Srivastava et al., and it has proven to be highly successful: even the state-of-the-art neural networks got a 1–2% accuracy boost simply by adding dropout. This may not sound like a lot, but when a model already has 95% accuracy, getting a 2% accuracy boost means dropping the error rate by almost 40% (going from 5% error to roughly 3%).

It is a fairly simple algorithm: at every training step, every neuron (including the input neurons, but always excluding the output neurons) has a probability p of being temporarily “dropped out,” meaning it will be entirely ignored during this training step, but it may be active during the next step (see [Figure 11-9](#)). The hyperparameter p is called the *dropout rate*, and it is typically set to 50%. After training, neurons don’t get dropped anymore. And that’s all (except for a technical detail we will discuss momentarily).

23 “Improving neural networks by preventing co-adaptation of feature detectors,” G. Hinton et al. (2012).

24 “Dropout: A Simple Way to Prevent Neural Networks from Overfitting,” N. Srivastava et al. (2014).

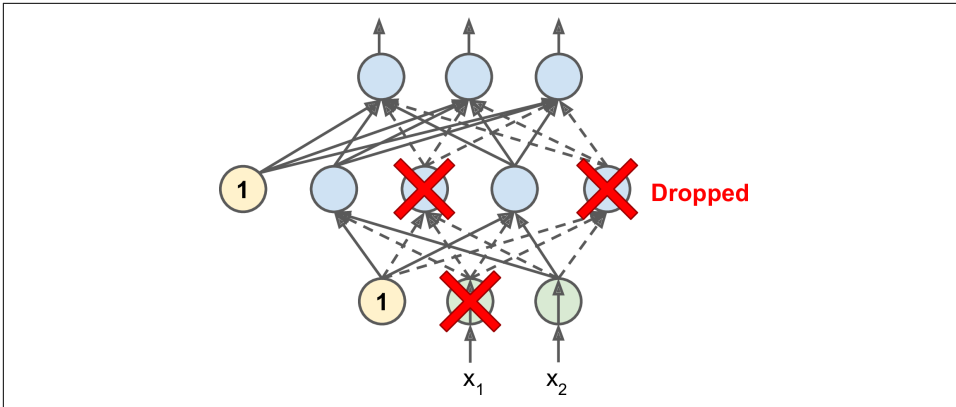

Figure 11-9. Dropout regularization

It is quite surprising at first that this rather brutal technique works at all. Would a company perform better if its employees were told to toss a coin every morning to decide whether or not to go to work? Well, who knows; perhaps it would! The company would obviously be forced to adapt its organization; it could not rely on any single person to fill in the coffee machine or perform any other critical tasks, so this expertise would have to be spread across several people. Employees would have to learn to cooperate with many of their coworkers, not just a handful of them. The company would become much more resilient. If one person quit, it wouldn't make much of a difference. It's unclear whether this idea would actually work for companies, but it certainly does for neural networks. Neurons trained with dropout cannot co-adapt with their neighboring neurons; they have to be as useful as possible on their own. They also cannot rely excessively on just a few input neurons; they must pay attention to each of their input neurons. They end up being less sensitive to slight changes in the inputs. In the end you get a more robust network that generalizes better.

Another way to understand the power of dropout is to realize that a unique neural network is generated at each training step. Since each neuron can be either present or absent, there is a total of 2^N possible networks (where N is the total number of droppable neurons). This is such a huge number that it is virtually impossible for the same neural network to be sampled twice. Once you have run a 10,000 training steps, you have essentially trained 10,000 different neural networks (each with just one training instance). These neural networks are obviously not independent since they share many of their weights, but they are nevertheless all different. The resulting neural network can be seen as an averaging ensemble of all these smaller neural networks.

There is one small but important technical detail. Suppose $p = 50\%$, in which case during testing a neuron will be connected to twice as many input neurons as it was (on average) during training. To compensate for this fact, we need to multiply each

neuron's input connection weights by 0.5 after training. If we don't, each neuron will get a total input signal roughly twice as large as what the network was trained on, and it is unlikely to perform well. More generally, we need to multiply each input connection weight by the *keep probability* ($1 - p$) after training. Alternatively, we can divide each neuron's output by the keep probability during training (these alternatives are not perfectly equivalent, but they work equally well).

To implement dropout using Keras, you can use the `keras.layers.Dropout` layer. During training, it randomly drops some inputs (setting them to 0) and divides the remaining inputs by the keep probability. After training, it does nothing at all, it just passes the inputs to the next layer. For example, the following code applies dropout regularization before every Dense layer, using a dropout rate of 0.2:

```
model = keras.models.Sequential([
    keras.layers.Flatten(input_shape=[28, 28]),
    keras.layers.Dropout(rate=0.2),
    keras.layers.Dense(300, activation="elu", kernel_initializer="he_normal"),
    keras.layers.Dropout(rate=0.2),
    keras.layers.Dense(100, activation="elu", kernel_initializer="he_normal"),
    keras.layers.Dropout(rate=0.2),
    keras.layers.Dense(10, activation="softmax")
])
```



Since dropout is only active during training, the training loss is penalized compared to the validation loss, so comparing the two can be misleading. In particular, a model may be overfitting the training set and yet have similar training and validation losses. So make sure to evaluate the training loss without dropout (e.g., after training). Alternatively, you can call the `fit()` method inside a `keras.backend.learning_phase_scope(1)` block: this will force dropout to be active during both training and validation.²⁵

If you observe that the model is overfitting, you can increase the dropout rate. Conversely, you should try decreasing the dropout rate if the model underfits the training set. It can also help to increase the dropout rate for large layers, and reduce it for small ones. Moreover, many state-of-the-art architectures only use dropout after the last hidden layer, so you may want to try this if full dropout is too strong.

Dropout does tend to significantly slow down convergence, but it usually results in a much better model when tuned properly. So, it is generally well worth the extra time and effort.

²⁵ This is specific to `tf.keras`, so you may prefer to use `keras.backend.set_learning_phase(1)` before calling the `fit()` method (and set it back to 0 right after).



If you want to regularize a self-normalizing network based on the SELU activation function (as discussed earlier), you should use AlphaDropout: this is a variant of dropout that preserves the mean and standard deviation of its inputs (it was introduced in the same paper as SELU, as regular dropout would break self-normalization).

Monte-Carlo (MC) Dropout

In 2016, a [paper](#)²⁶ by Yarin Gal and Zoubin Ghahramani added more good reasons to use dropout:

- First, the paper establishes a profound connection between dropout networks (i.e., neural networks containing a dropout layer before every weight layer) and approximate Bayesian inference²⁷, giving dropout a solid mathematical justification.
- Second, they introduce a powerful technique called *MC Dropout*, which can boost the performance of any trained dropout model, without having to retrain it or even modify it at all!
- Moreover, MC Dropout also provides a much better measure of the model's uncertainty.
- Finally, it is also amazingly simple to implement. If this all sounds like a “one weird trick” advertisement, then take a look at the following code. It is the full implementation of *MC Dropout*, boosting the dropout model we trained earlier, without retraining it:

```
with keras.backend.learning_phase_scope(1): # force training mode = dropout on
    y_probas = np.stack([model.predict(X_test_scaled)
                        for sample in range(100)])
y_proba = y_probas.mean(axis=0)
```

We first force training mode on, using a `learning_phase_scope(1)` context. This turns dropout on within the `with` block. Then we make 100 predictions over the test set, and we stack them. Since dropout is on, all predictions will be different. Recall that `predict()` returns a matrix with one row per instance, and one column per class. Since there are 10,000 instances in the test set, and 10 classes, this is a matrix of shape `[10000, 10]`. We stack 100 such matrices, so `y_probas` is an array of shape `[100, 10000, 10]`. Once we average over the first dimension (`axis=0`), we get `y_proba`, an array of shape `[10000, 10]`, like we would get with a single prediction. That's all! Averaging

26 “Dropout as a Bayesian Approximation: Representing Model Uncertainty in Deep Learning” Y. Gal and Z. Ghahramani (2016).

27 Specifically, they show that training a dropout network is mathematically equivalent to approximate Bayesian inference in a specific type of probabilistic model called a *deep Gaussian Process*.

over multiple predictions with dropout on gives us a Monte Carlo estimate that is generally more reliable than the result of a single prediction with dropout off. For example, let's look at the model's prediction for the first instance in the test set, with dropout off:

```
>>> np.round(model.predict(X_test_scaled[:1]), 2)
array([[0. , 0. , 0. , 0. , 0. , 0. , 0. , 0.01, 0. , 0.99]],
      dtype=float32)
```

The model seems almost certain that this image belongs to class 9 (ankle boot). Should you trust it? Is there really so little room for doubt? Compare this with the predictions made when dropout is activated:

```
>>> np.round(y_probab[:, :1], 2)
array([[0. , 0. , 0. , 0. , 0. , 0.14, 0. , 0.17, 0. , 0.68]],
      [[0. , 0. , 0. , 0. , 0. , 0.16, 0. , 0.2 , 0. , 0.64]],
      [[0. , 0. , 0. , 0. , 0. , 0.02, 0. , 0.01, 0. , 0.97]],
      [...])
```

This tells a very different story: apparently, when we activate dropout, the model is not sure anymore. It still seems to prefer class 9, but sometimes it hesitates with classes 5 (sandal) and 7 (sneaker), which makes sense given they're all footwear. Once we average over the first dimension, we get the following MC dropout predictions:

```
>>> np.round(y_proba[:1], 2)
array([[0. , 0. , 0. , 0. , 0. , 0.22, 0. , 0.16, 0. , 0.62]],
      dtype=float32)
```

The model still thinks this image belongs to class 9, but only with a 62% confidence, which seems much more reasonable than 99%. Plus it's useful to know exactly which other classes it thinks are likely. And you can also take a look at the **standard deviation of the probability estimates**:

```
>>> y_std = y_probab.std(axis=0)
>>> np.round(y_std[:1], 2)
array([[0. , 0. , 0. , 0. , 0. , 0.28, 0. , 0.21, 0.02, 0.32]],
      dtype=float32)
```

Apparently there's quite a lot of variance in the probability estimates: if you were building a risk-sensitive system (e.g., a medical or financial system), you should probably treat such an uncertain prediction with extreme caution. You definitely would not treat it like a 99% confident prediction. Moreover, the model's accuracy got a small boost from 86.8 to 86.9:

```
>>> accuracy = np.sum(y_pred == y_test) / len(y_test)
>>> accuracy
0.8694
```



The number of Monte Carlo samples you use (100 in this example) is a hyperparameter you can tweak. The higher it is, the more accurate the predictions and their uncertainty estimates will be. However, if you double it, inference time will also be doubled. Moreover, above a certain number of samples, you will notice little improvement. So your job is to find the right tradeoff between latency and accuracy, depending on your application.

If your model contains other layers that behave in a special way during training (such as Batch Normalization layers), then you should not force training mode like we just did. Instead, you should replace the Dropout layers with the following MCDropout class:

```
class MCDropout(keras.layers.Dropout):
    def call(self, inputs):
        return super().call(inputs, training=True)
```

We just subclass the Dropout layer and override the call() method to force its training argument to True (see Chapter 12). Similarly, you could define an MCAAlphaDropout class by subclassing AlphaDropout instead. If you are creating a model from scratch, it's just a matter of using MCDropout rather than Dropout. But if you have a model that was already trained using Dropout, you need to create a new model, identical to the existing model except replacing the Dropout layers with MCDropout, then copy the existing model's weights to your new model.

In short, MC Dropout is a fantastic technique that boosts dropout models and provides better uncertainty estimates. And of course, since it is just regular dropout during training, it also acts like a regularizer.

Max-Norm Regularization

Another regularization technique that is quite popular for neural networks is called *max-norm regularization*: for each neuron, it constrains the weights \mathbf{w} of the incoming connections such that $\|\mathbf{w}\|_2 \leq r$, where r is the max-norm hyperparameter and $\|\cdot\|_2$ is the ℓ_2 norm.

Max-norm regularization does not add a regularization loss term to the overall loss function. Instead, it is typically implemented by computing $\|\mathbf{w}\|_2$ after each training step and clipping \mathbf{w} if needed ($\mathbf{w} \leftarrow \mathbf{w} \frac{r}{\|\mathbf{w}\|_2}$).

Reducing r increases the amount of regularization and helps reduce overfitting. Max-norm regularization can also help alleviate the vanishing/exploding gradients problems (if you are not using Batch Normalization).

To implement max-norm regularization in Keras, just set every hidden layer's `kernel_constraint` argument to a `max_norm()` constraint, with the appropriate max value, for example:

```
keras.layers.Dense(100, activation="elu", kernel_initializer="he_normal",  
                  kernel_constraint=keras.constraints.max_norm(1.))
```

After each training iteration, the model's `fit()` method will call the object returned by `max_norm()`, passing it the layer's weights and getting clipped weights in return, which then replace the layer's weights. As we will see in [Chapter 12](#), you can define your own custom constraint function if you ever need to, and use it as the `kernel_constraint`. You can also constrain the bias terms by setting the `bias_constraint` argument.

The `max_norm()` function has an `axis` argument that defaults to 0. A Dense layer usually has weights of shape [number of inputs, number of neurons], so using `axis=0` means that the max norm constraint will apply independently to each neuron's weight vector. If you want to use max-norm with convolutional layers (see [Chapter 14](#)), make sure to set the `max_norm()` constraint's `axis` argument appropriately (usually `axis=[0, 1, 2]`).

Summary and Practical Guidelines

In this chapter, we have covered a wide range of techniques and you may be wondering which ones you should use. The configuration in [Table 11-2](#) will work fine in most cases, without requiring much hyperparameter tuning.

Table 11-2. Default DNN configuration

Hyperparameter	Default value
Kernel initializer:	LeCun initialization
Activation function:	SELU
Normalization:	None (self-normalization)
Regularization:	Early stopping
Optimizer:	Nadam
Learning rate schedule:	Performance scheduling

Don't forget to standardize the input features! Of course, you should also try to reuse parts of a pretrained neural network if you can find one that solves a similar problem, or use unsupervised pretraining if you have a lot of unlabeled data, or pretraining on an auxiliary task if you have a lot of labeled data for a similar task.

The default configuration in [Table 11-2](#) may need to be tweaked:

- If your model self-normalizes:
 - If it overfits the training set, then you should add alpha dropout (and always use early stopping as well). Do not use other regularization methods, or else they would break self-normalization.
- If your model cannot self-normalize (e.g., it is a recurrent net or it contains skip connections):
 - You can try using ELU (or another activation function) instead of SELU, it may perform better. Make sure to change the initialization method accordingly (e.g., He init for ELU or ReLU).
 - If it is a deep network, you should use Batch Normalization after every hidden layer. If it overfits the training set, you can also try using max-norm or ℓ_2 regularization.
- If you need a sparse model, you can use ℓ_1 regularization (and optionally zero out the tiny weights after training). If you need an even sparser model, you can try using FTRL instead of Nadam optimization, along with ℓ_1 regularization. In any case, this will break self-normalization, so you will need to switch to BN if your model is deep.
- If you need a low-latency model (one that performs lightning-fast predictions), you may need to use less layers, avoid Batch Normalization, and possibly replace the SELU activation function with the leaky ReLU. Having a sparse model will also help. You may also want to reduce the float precision from 32-bits to 16-bit (or even 8-bits) (see ???).
- If you are building a risk-sensitive application, or inference latency is not very important in your application, you can use MC Dropout to boost performance and get more reliable probability estimates, along with uncertainty estimates.

With these guidelines, you are now ready to train very deep nets! I hope you are now convinced that you can go a very long way using just Keras. However, there may come a time when you need to have even more control, for example to write a custom loss function or to tweak the training algorithm. For such cases, you will need to use TensorFlow's lower-level API, as we will see in the next chapter.

Exercises

1. Is it okay to initialize all the weights to the same value as long as that value is selected randomly using He initialization?
2. Is it okay to initialize the bias terms to 0?
3. Name three advantages of the SELU activation function over ReLU.

4. In which cases would you want to use each of the following activation functions: SELU, leaky ReLU (and its variants), ReLU, tanh, logistic, and softmax?
5. What may happen if you set the momentum hyperparameter too close to 1 (e.g., 0.99999) when using an SGD optimizer?
6. Name three ways you can produce a sparse model.
7. Does dropout slow down training? Does it slow down inference (i.e., making predictions on new instances)? What are about MC dropout?
8. Deep Learning.
 - a. Build a DNN with five hidden layers of 100 neurons each, He initialization, and the ELU activation function.
 - b. Using Adam optimization and early stopping, try training it on MNIST but only on digits 0 to 4, as we will use transfer learning for digits 5 to 9 in the next exercise. You will need a softmax output layer with five neurons, and as always make sure to save checkpoints at regular intervals and save the final model so you can reuse it later.
 - c. Tune the hyperparameters using cross-validation and see what precision you can achieve.
 - d. Now try adding Batch Normalization and compare the learning curves: is it converging faster than before? Does it produce a better model?
 - e. Is the model overfitting the training set? Try adding dropout to every layer and try again. Does it help?
9. Transfer learning.
 - a. Create a new DNN that reuses all the pretrained hidden layers of the previous model, freezes them, and replaces the softmax output layer with a new one.
 - b. Train this new DNN on digits 5 to 9, using only 100 images per digit, and time how long it takes. Despite this small number of examples, can you achieve high precision?
 - c. Try caching the frozen layers, and train the model again: how much faster is it now?
 - d. Try again reusing just four hidden layers instead of five. Can you achieve a higher precision?
 - e. Now unfreeze the top two hidden layers and continue training: can you get the model to perform even better?
10. Pretraining on an auxiliary task.
 - a. In this exercise you will build a DNN that compares two MNIST digit images and predicts whether they represent the same digit or not. Then you will reuse the lower layers of this network to train an MNIST classifier using very little

training data. Start by building two DNNs (let's call them DNN A and B), both similar to the one you built earlier but without the output layer: each DNN should have five hidden layers of 100 neurons each, He initialization, and ELU activation. Next, add one more hidden layer with 10 units on top of both DNNs. To do this, you should use a `keras.layers.Concatenate` layer to concatenate the outputs of both DNNs for each instance, then feed the result to the hidden layer. Finally, add an output layer with a single neuron using the logistic activation function.

- b. Split the MNIST training set in two sets: split #1 should contain 55,000 images, and split #2 should contain 5,000 images. Create a function that generates a training batch where each instance is a pair of MNIST images picked from split #1. Half of the training instances should be pairs of images that belong to the same class, while the other half should be images from different classes. For each pair, the training label should be 0 if the images are from the same class, or 1 if they are from different classes.
- c. Train the DNN on this training set. For each image pair, you can simultaneously feed the first image to DNN A and the second image to DNN B. The whole network will gradually learn to tell whether two images belong to the same class or not.
- d. Now create a new DNN by reusing and freezing the hidden layers of DNN A and adding a softmax output layer on top with 10 neurons. Train this network on split #2 and see if you can achieve high performance despite having only 500 images per class.

Solutions to these exercises are available in [???](#).

Custom Models and Training with TensorFlow



With Early Release ebooks, you get books in their earliest form—the author’s raw and unedited content as he or she writes—so you can take advantage of these technologies long before the official release of these titles. The following will be Chapter 12 in the final release of the book.

So far we have used only TensorFlow’s high level API, `tf.keras`, but it already got us pretty far: we built various neural network architectures, including regression and classification nets, wide & deep nets and self-normalizing nets, using all sorts of techniques, such as Batch Normalization, dropout, learning rate schedules, and more. In fact, 95% of the use cases you will encounter will not require anything else than `tf.keras` (and `tf.data`, see [Chapter 13](#)). But now it’s time to dive deeper into TensorFlow and take a look at its lower-level [Python API](#). This will be useful when you need extra control, to write custom loss functions, custom metrics, layers, models, initializers, regularizers, weight constraints and more. You may even need to fully control the training loop itself, for example to apply special transformations or constraints to the gradients (beyond just clipping them), or to use multiple optimizers for different parts of the network. We will cover all these cases in this chapter, then we will also look at how you can boost your custom models and training algorithms using TensorFlow’s automatic graph generation feature. But first, let’s take a quick tour of TensorFlow.



TensorFlow 2.0 was released in March 2019, making TensorFlow much easier to use. The first edition of this book used TF 1, while this edition uses TF 2.

A Quick Tour of TensorFlow

As you know, *TensorFlow* is a powerful library for numerical computation, particularly well suited and fine-tuned for large-scale Machine Learning (but you could use it for anything else that requires heavy computations). It was developed by the Google Brain team and it powers many of Google's large-scale services, such as Google Cloud Speech, Google Photos, and Google Search. It was open sourced in November 2015, and it is now the most popular deep learning library (in terms of citations in papers, adoption in companies, stars on github, etc.): countless projects use TensorFlow for all sorts of Machine Learning tasks, such as image classification, natural language processing (NLP), recommender systems, time series forecasting, and much more.

So what does TensorFlow actually offer? Here's a summary:

- Its core is very similar to NumPy, but with GPU support.
- It also supports distributed computing (across multiple devices and servers).
- It includes a kind of just-in-time (JIT) compiler that allows it to optimize computations for speed and memory usage: it works by extracting the *computation graph* from a Python function, then optimizing it (e.g., by pruning unused nodes) and finally running it efficiently (e.g., by automatically running independent operations in parallel).
- Computation graphs can be exported to a portable format, so you can train a TensorFlow model in one environment (e.g., using Python on Linux), and run it in another (e.g., using Java on an Android device).
- It implements autodiff (see [Chapter 10](#) and ???), and provides some excellent optimizers, such as RMSProp, Nadam and FTRL (see [Chapter 11](#)), so you can easily minimize all sorts of loss functions.
- TensorFlow offers many more features, built on top of these core features: the most important is of course `tf.keras`¹, but it also has data loading & preprocessing ops (`tf.data`, `tf.io`, etc.), image processing ops (`tf.image`), signal processing ops (`tf.signal`), and more (see [Figure 12-1](#) for an overview of TensorFlow's Python API).

¹ TensorFlow also includes another Deep Learning API called the *Estimators API*, but it is now recommended to use `tf.keras` instead.

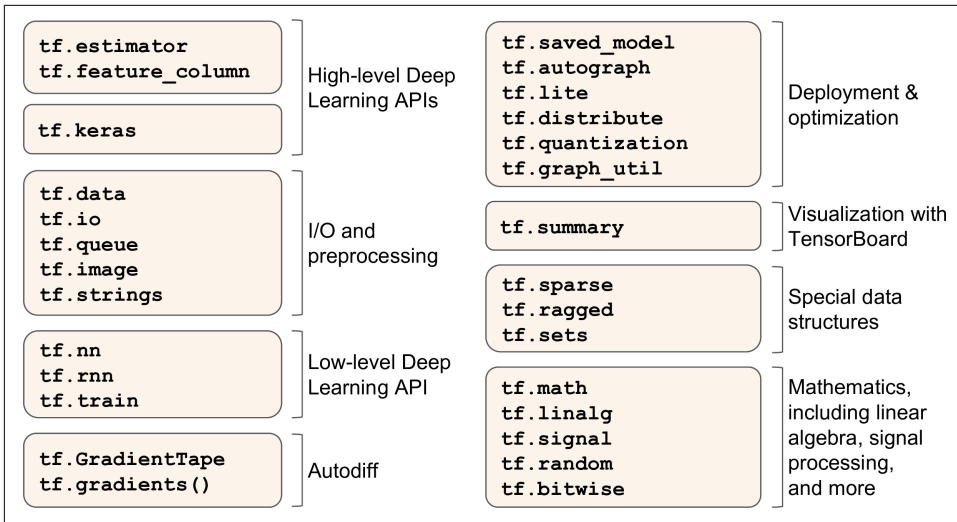

Figure 12-1. TensorFlow's Python API



We will cover many of the packages and functions of the TensorFlow API, but it's impossible to cover them all so you should really take some time to browse through the API: you will find that it is quite rich and well documented.

At the lowest level, each TensorFlow operation is implemented using highly efficient C++ code². Many operations (or *ops* for short) have multiple implementations, called *kernels*: each kernel is dedicated to a specific device type, such as CPUs, GPUs, or even TPUs (*Tensor Processing Units*). As you may know, GPUs can dramatically speed up computations by splitting computations into many smaller chunks and running them in parallel across many GPU threads. TPUs are even faster. You can purchase your own GPU devices (for now, TensorFlow only supports Nvidia cards with CUDA Compute Capability 3.5+), but TPUs are only available on *Google Cloud Machine Learning Engine* (see ???).³

TensorFlow's architecture is shown in Figure 12-2: most of the time your code will use the high level APIs (especially `tf.keras` and `tf.data`), but when you need more flexibility you will use the lower level Python API, handling tensors directly. Note that APIs for other languages are also available. In any case, TensorFlow's execution

² If you ever need to (but you probably won't), you can write your own operations using the C++ API.

³ If you are a researcher, you may be eligible to use these TPUs for free, see <https://tensorflow.org/tfrc/> for more details.

engine will take care of running the operations efficiently, even across multiple devices and machines if you tell it to.

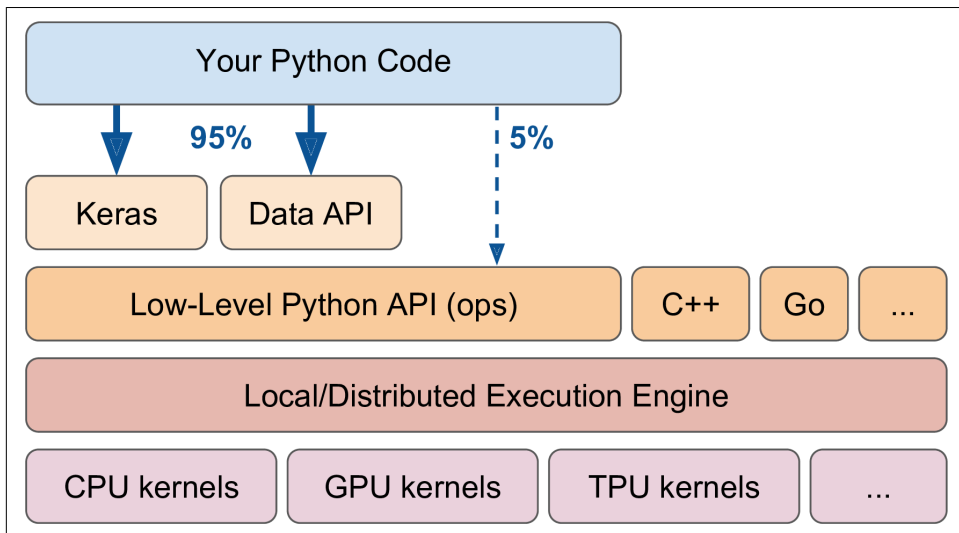

Figure 12-2. TensorFlow's architecture

TensorFlow runs not only on Windows, Linux, and MacOS, but also on mobile devices (using *TensorFlow Lite*), including both iOS and Android (see ???). If you do not want to use the Python API, there are also C++, Java, Go and Swift APIs. There is even a Javascript implementation called *TensorFlow.js* that makes it possible to run your models directly in your browser.

There's more to TensorFlow than just the library. TensorFlow is at the center of an extensive ecosystem of libraries. First, there's TensorBoard for visualization (see Chapter 10). Next, there's **TensorFlow Extended (TFX)**, which is a set of libraries built by Google to productionize TensorFlow projects: it includes tools for data validation, preprocessing, model analysis and serving (with TF Serving, see ???). Google also launched *TensorFlow Hub*, a way to easily download and reuse pretrained neural networks. You can also get many neural network architectures, some of them pretrained, in TensorFlow's **model garden**. Check out the **TensorFlow Resources**, or <https://github.com/jtoy/awesome-tensorflow> for more TensorFlow-based projects. You will find hundreds of TensorFlow projects on GitHub, so it is often easy to find existing code for whatever you are trying to do.



More and more ML papers are released along with their implementation, and sometimes even with pretrained models. Check out <https://paperswithcode.com/> to easily find them.

Last but not least, TensorFlow has a dedicated team of passionate and helpful developers, and a large community contributing to improving it. To ask technical questions, you should use <http://stackoverflow.com/> and tag your question with *tensorflow* and *python*. You can file bugs and feature requests through GitHub. For general discussions, join the [Google group](#).

Okay, it's time to start coding!

Using TensorFlow like NumPy

TensorFlow's API revolves around *tensors*, hence the name Tensor-Flow. A tensor is usually a multidimensional array (exactly like a NumPy `ndarray`), but it can also hold a scalar (a simple value, such as 42). These tensors will be important when we create custom cost functions, custom metrics, custom layers and more, so let's see how to create and manipulate them.

Tensors and Operations

You can easily create a tensor, using `tf.constant()`. For example, here is a tensor representing a matrix with two rows and three columns of floats:

```
>>> tf.constant([[1., 2., 3.], [4., 5., 6.]]) # matrix
<tf.Tensor: id=0, shape=(2, 3), dtype=float32, numpy=
array([[1., 2., 3.],
       [4., 5., 6.]], dtype=float32)>
>>> tf.constant(42) # scalar
<tf.Tensor: id=1, shape=(), dtype=int32, numpy=42>
```

Just like an `ndarray`, a `tf.Tensor` has a `shape` and a data type (`dtype`):

```
>>> t = tf.constant([[1., 2., 3.], [4., 5., 6.]])
>>> t.shape
TensorShape([2, 3])
>>> t.dtype
tf.float32
```

Indexing works much like in NumPy:

```
>>> t[:, 1:]
<tf.Tensor: id=5, shape=(2, 2), dtype=float32, numpy=
array([[2., 3.],
       [5., 6.]], dtype=float32)>
>>> t[..., 1, tf.newaxis]
<tf.Tensor: id=15, shape=(2, 1), dtype=float32, numpy=
array([[2.],
       [5.]], dtype=float32)>
```

Most importantly, all sorts of tensor operations are available:

```
>>> t + 10
<tf.Tensor: id=18, shape=(2, 3), dtype=float32, numpy=
```

```

array([[11., 12., 13.],
       [14., 15., 16.]], dtype=float32)>
>>> tf.square(t)
<tf.Tensor: id=20, shape=(2, 3), dtype=float32, numpy=
array([[ 1.,  4.,  9.],
       [16., 25., 36.]], dtype=float32)>
>>> t @ tf.transpose(t)
<tf.Tensor: id=24, shape=(2, 2), dtype=float32, numpy=
array([[14., 32.],
       [32., 77.]], dtype=float32)>

```

Note that writing `t + 10` is equivalent to calling `tf.add(t, 10)` (indeed, Python calls the magic method `t.__add__(10)`, which just calls `tf.add(t, 10)`). Other operators (like `-`, `*`, etc.) are also supported. The `@` operator was added in Python 3.5, for matrix multiplication: it is equivalent to calling the `tf.matmul()` function.

You will find all the basic math operations you need (e.g., `tf.add()`, `tf.multiply()`, `tf.square()`, `tf.exp()`, `tf.sqrt()`...), and more generally most operations that you can find in NumPy (e.g., `tf.reshape()`, `tf.squeeze()`, `tf.tile()`), but sometimes with a different name (e.g., `tf.reduce_mean()`, `tf.reduce_sum()`, `tf.reduce_max()`, `tf.math.log()` are the equivalent of `np.mean()`, `np.sum()`, `np.max()` and `np.log()`). When the name differs, there is often a good reason for it: for example, in TensorFlow you must write `tf.transpose(t)`, you cannot just write `t.T` like in NumPy. The reason is that it does not do exactly the same thing: in TensorFlow, a new tensor is created with its own copy of the transposed data, while in NumPy, `t.T` is just a transposed view on the same data. Similarly, the `tf.reduce_sum()` operation is named this way because its GPU kernel (i.e., GPU implementation) uses a reduce algorithm that does not guarantee the order in which the elements are added: because 32-bit floats have limited precision, this means that the result may change ever so slightly every time you call this operation. The same is true of `tf.reduce_mean()` (but of course `tf.reduce_max()` is deterministic).



Many functions and classes have aliases. For example, `tf.add()` and `tf.math.add()` are the same function. This allows TensorFlow to have concise names for the most common operations⁴, while preserving well organized packages.

Keras' Low-Level API

The Keras API actually has its own low-level API, located in `keras.backend`. It includes functions like `square()`, `exp()`, `sqrt()` and so on. In `tf.keras`, these functions generally just call the corresponding TensorFlow operations. If you want to write code that will be portable to other Keras implementations, you should use these Keras functions. However, they only cover a subset of all functions available in TensorFlow, so in this book we will use the TensorFlow operations directly. Here is as simple example using `keras.backend`, which is commonly named `K` for short:

```
>>> from tensorflow import keras
>>> K = keras.backend
>>> K.square(K.transpose(t)) + 10
<tf.Tensor: id=39, shape=(3, 2), dtype=float32, numpy=
array([[11., 26.],
       [14., 35.],
       [19., 46.]], dtype=float32)>
```

Tensors and NumPy

Tensors play nice with NumPy: you can create a tensor from a NumPy array, and vice versa, and you can even apply TensorFlow operations to NumPy arrays and NumPy operations to tensors:

```
>>> a = np.array([2., 4., 5.])
>>> tf.constant(a)
<tf.Tensor: id=111, shape=(3,), dtype=float64, numpy=array([2., 4., 5.])>
>>> t.numpy() # or np.array(t)
array([[1., 2., 3.],
       [4., 5., 6.]], dtype=float32)
>>> tf.square(a)
<tf.Tensor: id=116, shape=(3,), dtype=float64, numpy=array([4., 16., 25.])>
>>> np.square(t)
array([[ 1.,  4.,  9.],
       [16., 25., 36.]], dtype=float32)
```

⁴ A notable exception is `tf.math.log()` which is commonly used but there is no `tf.log()` alias (as it might be confused with logging).



Notice that NumPy uses 64-bit precision by default, while TensorFlow uses 32-bit. This is because 32-bit precision is generally more than enough for neural networks, plus it runs faster and uses less RAM. So when you create a tensor from a NumPy array, make sure to set `dtype=tf.float32`.

Type Conversions

Type conversions can significantly hurt performance, and they can easily go unnoticed when they are done automatically. To avoid this, TensorFlow does not perform any type conversions automatically: it just raises an exception if you try to execute an operation on tensors with incompatible types. For example, you cannot add a float tensor and an integer tensor, and you cannot even add a 32-bit float and a 64-bit float:

```
>>> tf.constant(2.) + tf.constant(40)
Traceback[...]:InvalidArgumentError[...]:expected to be a float[...]
>>> tf.constant(2.) + tf.constant(40., dtype=tf.float64)
Traceback[...]:InvalidArgumentError[...]:expected to be a double[...]
```

This may be a bit annoying at first, but remember that it's for a good cause! And of course you can use `tf.cast()` when you really need to convert types:

```
>>> t2 = tf.constant(40., dtype=tf.float64)
>>> tf.constant(2.0) + tf.cast(t2, tf.float32)
<tf.Tensor: id=136, shape=(), dtype=float32, numpy=42.0>
```

Variables

So far, we have used constant tensors: as their name suggests, you cannot modify them. However, the weights in a neural network need to be tweaked by backpropagation, and other parameters may also need to change over time (e.g., a momentum optimizer keeps track of past gradients). What we need is a `tf.Variable`:

```
>>> v = tf.Variable([[1., 2., 3.], [4., 5., 6.]])
>>> v
<tf.Variable 'Variable:0' shape=(2, 3) dtype=float32, numpy=
array([[1., 2., 3.],
       [4., 5., 6.]], dtype=float32)>
```

A `tf.Variable` acts much like a constant tensor: you can perform the same operations with it, it plays nicely with NumPy as well, and it is just as picky with types. But it can also be modified in place using the `assign()` method (or `assign_add()` or `assign_sub()` which increment or decrement the variable by the given value). You can also modify individual cells (or slices), using the cell's (or slice's) `assign()` method (direct item assignment will not work), or using the `scatter_update()` or `scatter_nd_update()` methods:

```
v.assign(2 * v)           # => [[2., 4., 6.], [8., 10., 12.]]
v[0, 1].assign(42)       # => [[2., 42., 6.], [8., 10., 12.]]
```



```
v[:, 2].assign([0., 1.]) # => [[2., 42., 0.], [8., 10., 1.]]
v.scatter_nd_update(indices=[[0, 0], [1, 2]], updates=[100., 200.])
# => [[100., 42., 0.], [8., 10., 200.]]
```



In practice you will rarely have to create variables manually, since Keras provides an `add_weight()` method that will take care of it for you, as we will see. Moreover, model parameters will generally be updated directly by the optimizers, so you will rarely need to update variables manually.

Other Data Structures

TensorFlow supports several other data structures, including the following (please see the notebook or ??? for more details):

- *Sparse tensors* (`tf.SparseTensor`) efficiently represent tensors containing mostly 0s. The `tf.sparse` package contains operations for sparse tensors.
- *Tensor arrays* (`tf.TensorArray`) are lists of tensors. They have a fixed size by default, but can optionally be made dynamic. All tensors they contain must have the same shape and data type.
- *Ragged tensors* (`tf.RaggedTensor`) represent static lists of lists of tensors, where every tensor has the same shape and data type. The `tf.ragged` package contains operations for ragged tensors.
- *String tensors* are regular tensors of type `tf.string`. These actually represent byte strings, not Unicode strings, so if you create a string tensor using a Unicode string (e.g., a regular Python 3 string like "café"), then it will get encoded to UTF-8 automatically (e.g., `b"caf\xc3\xa9"`). Alternatively, you can represent Unicode strings using tensors of type `tf.int32`, where each item represents a Unicode codepoint (e.g., `[99, 97, 102, 233]`). The `tf.strings` package (with an `s`) contains ops for byte strings and Unicode strings (and to convert one into the other).
- *Sets* are just represented as regular tensors (or sparse tensors) containing one or more sets, and you can manipulate them using operations from the `tf.sets` package.
- *Queues*, including First In, First Out (FIFO) queues (`FIFOQueue`), queues that can prioritize some items (`PriorityQueue`), queues that shuffle their items (`RandomShuffleQueue`), and queues that can batch items of different shapes by padding (`PaddingFIFOQueue`). These classes are all in the `tf.queue` package.

With tensors, operations, variables and various data structures at your disposal, you are now ready to customize your models and training algorithms!

Customizing Models and Training Algorithms

Let's start by creating a custom loss function, which is a simple and common use case.

Custom Loss Functions

Suppose you want to train a regression model, but your training set is a bit noisy. Of course, you start by trying to clean up your dataset by removing or fixing the outliers, but it turns out to be insufficient, the dataset is still noisy. Which loss function should you use? The mean squared error might penalize large errors too much, so your model will end up being imprecise. The mean absolute error would not penalize outliers as much, but training might take a while to converge and the trained model might not be very precise. This is probably a good time to use the Huber loss (introduced in [Chapter 10](#)) instead of the good old MSE. The Huber loss is not currently part of the official Keras API, but it is available in `tf.keras` (just use an instance of the `keras.losses.Huber` class). But let's pretend it's not there: implementing it is easy as pie! Just create a function that takes the labels and predictions as arguments, and use TensorFlow operations to compute every instance's loss:

```
def huber_fn(y_true, y_pred):
    error = y_true - y_pred
    is_small_error = tf.abs(error) < 1
    squared_loss = tf.square(error) / 2
    linear_loss = tf.abs(error) - 0.5
    return tf.where(is_small_error, squared_loss, linear_loss)
```



For better performance, you should use a vectorized implementation, as in this example. Moreover, if you want to benefit from TensorFlow's graph features, you should use only TensorFlow operations.

It is also preferable to return a tensor containing one loss per instance, rather than returning the mean loss. This way, Keras can apply class weights or sample weights when requested (see [Chapter 10](#)).

Next, you can just use this loss when you compile the Keras model, then train your model:

```
model.compile(loss=huber_fn, optimizer="nadam")
model.fit(X_train, y_train, [...])
```

And that's it! For each batch during training, Keras will call the `huber_fn()` function to compute the loss, and use it to perform a Gradient Descent step. Moreover, it will keep track of the total loss since the beginning of the epoch, and it will display the mean loss.

But what happens to this custom loss when we save the model?

Saving and Loading Models That Contain Custom Components

Saving a model containing a custom loss function actually works fine, as Keras just saves the name of the function. However, whenever you load it, you need to provide a dictionary that maps the function name to the actual function. More generally, when you load a model containing custom objects, you need to map the names to the objects:

```
model = keras.models.load_model("my_model_with_a_custom_loss.h5",
                                custom_objects={"huber_fn": huber_fn})
```

With the current implementation, any error between -1 and 1 is considered “small”. But what if we want a different threshold? One solution is to create a function that creates a configured loss function:

```
def create_huber(threshold=1.0):
    def huber_fn(y_true, y_pred):
        error = y_true - y_pred
        is_small_error = tf.abs(error) < threshold
        squared_loss = tf.square(error) / 2
        linear_loss = threshold * tf.abs(error) - threshold**2 / 2
        return tf.where(is_small_error, squared_loss, linear_loss)
    return huber_fn

model.compile(loss=create_huber(2.0), optimizer="nadam")
```

Unfortunately, when you save the model, the threshold will not be saved. This means that you will have to specify the threshold value when loading the model (note that the name to use is "huber_fn", which is the name of the function we gave Keras, not the name of the function that created it):

```
model = keras.models.load_model("my_model_with_a_custom_loss_threshold_2.h5",
                                custom_objects={"huber_fn": create_huber(2.0)})
```

You can solve this by creating a subclass of the `keras.losses.Loss` class, and implement its `get_config()` method:

```
class HuberLoss(keras.losses.Loss):
    def __init__(self, threshold=1.0, **kwargs):
        self.threshold = threshold
        super().__init__(**kwargs)
    def call(self, y_true, y_pred):
        error = y_true - y_pred
        is_small_error = tf.abs(error) < self.threshold
        squared_loss = tf.square(error) / 2
        linear_loss = self.threshold * tf.abs(error) - self.threshold**2 / 2
        return tf.where(is_small_error, squared_loss, linear_loss)
    def get_config(self):
        base_config = super().get_config()
        return {**base_config, "threshold": self.threshold}
```



The Keras API only specifies how to use subclassing to define layers, models, callbacks, and regularizers. If you build other components (such as losses, metrics, initializers or constraints) using subclassing, they may not be portable to other Keras implementations.

Let's walk through this code:

- The constructor accepts `**kwargs` and passes them to the parent constructor, which handles standard hyperparameters: the `name` of the loss and the `reduction` algorithm to use to aggregate the individual instance losses. By default, it is `"sum_over_batch_size"`, which means that the loss will be the sum of the instance losses, possibly weighted by the sample weights, if any, and then divide the result by the batch size (not by the sum of weights, so this is *not* the weighted mean).⁵ Other possible values are `"sum"` and `None`.
- The `call()` method takes the labels and predictions, computes all the instance losses, and returns them.
- The `get_config()` method returns a dictionary mapping each hyperparameter name to its value. It first calls the parent class's `get_config()` method, then adds the new hyperparameters to this dictionary (note that the convenient `{**x}` syntax was added in Python 3.5).

You can then use any instance of this class when you compile the model:

```
model.compile(loss=HuberLoss(2.), optimizer="nadam")
```

When you save the model, the threshold will be saved along with it, and when you load the model you just need to map the class name to the class itself:

```
model = keras.models.load_model("my_model_with_a_custom_loss_class.h5",  
                                custom_objects={"HuberLoss": HuberLoss})
```

When you save a model, Keras calls the loss instance's `get_config()` method and saves the config as JSON in the HDF5 file. When you load the model, it calls the `from_config()` class method on the `HuberLoss` class: this method is implemented by the base class (`Loss`) and just creates an instance of the class, passing `**config` to the constructor.

That's it for losses! It was not too hard, was it? Well it's just as simple for custom activation functions, initializers, regularizers, and constraints. Let's look at these now.

⁵ It would not be a good idea to use a weighted mean: if we did, then two instances with the same weight but in different batches would have a different impact on training, depending on the total weight of each batch.

Custom Activation Functions, Initializers, Regularizers, and Constraints

Most Keras functionalities, such as losses, regularizers, constraints, initializers, metrics, activation functions, layers and even full models can be customized in very much the same way. Most of the time, you will just need to write a simple function, with the appropriate inputs and outputs. For example, here are examples of a custom activation function (equivalent to `keras.activations.softplus` or `tf.nn.softplus`), a custom Glorot initializer (equivalent to `keras.initializers.glorot_normal`), a custom ℓ_1 regularizer (equivalent to `keras.regularizers.l1(0.01)`) and a custom constraint that ensures weights are all positive (equivalent to `keras.constraints.nonneg()` or `tf.nn.relu`):

```
def my_softplus(z): # return value is just tf.nn.softplus(z)
    return tf.math.log(tf.exp(z) + 1.0)

def my_glorot_initializer(shape, dtype=tf.float32):
    stddev = tf.sqrt(2. / (shape[0] + shape[1]))
    return tf.random.normal(shape, stddev=stddev, dtype=dtype)

def my_l1_regularizer(weights):
    return tf.reduce_sum(tf.abs(0.01 * weights))

def my_positive_weights(weights): # return value is just tf.nn.relu(weights)
    return tf.where(weights < 0., tf.zeros_like(weights), weights)
```

As you can see, the arguments depend on the type of custom function. These custom functions can then be used normally, for example:

```
layer = keras.layers.Dense(30, activation=my_softplus,
                           kernel_initializer=my_glorot_initializer,
                           kernel_regularizer=my_l1_regularizer,
                           kernel_constraint=my_positive_weights)
```

The activation function will be applied to the output of this Dense layer, and its result will be passed on to the next layer. The layer's weights will be initialized using the value returned by the initializer. At each training step the weights will be passed to the regularization function to compute the regularization loss, which will be added to the main loss to get the final loss used for training. Finally, the constraint function will be called after each training step, and the layer's weights will be replaced by the constrained weights.

If a function has some hyperparameters that need to be saved along with the model, then you will want to subclass the appropriate class, such as `keras.regularizers.Regularizer`, `keras.constraints.Constraint`, `keras.initializers.Initializer` or `keras.layers.Layer` (for any layer, including activation functions). For example, much like we did for the custom loss, here is a simple class for ℓ_1 regulariza-

tion, that saves its `factor` hyperparameter (this time we do not need to call the parent constructor or the `get_config()` method, as they are not defined by the parent class):

```
class MyL1Regularizer(keras.regularizers.Regularizer):
    def __init__(self, factor):
        self.factor = factor
    def __call__(self, weights):
        return tf.reduce_sum(tf.abs(self.factor * weights))
    def get_config(self):
        return {"factor": self.factor}
```

Note that you must implement the `call()` method for losses, layers (including activation functions) and models, or the `__call__()` method for regularizers, initializers and constraints. For metrics, things are a bit different, as we will see now.

Custom Metrics

Losses and metrics are conceptually not the same thing: losses are used by Gradient Descent to *train* a model, so they must be differentiable (at least where they are evaluated) and their gradients should not be 0 everywhere. Plus, it's okay if they are not easily interpretable by humans (e.g. cross-entropy). In contrast, metrics are used to *evaluate* a model, they must be more easily interpretable, and they can be non-differentiable or have 0 gradients everywhere (e.g., accuracy).

That said, in most cases, defining a custom metric function is exactly the same as defining a custom loss function. In fact, we could even use the Huber loss function we created earlier as a metric⁶, it would work just fine (and persistence would also work the same way, in this case only saving the name of the function, "huber_fn"):

```
model.compile(loss="mse", optimizer="nadam", metrics=[create_huber(2.0)])
```

For each batch during training, Keras will compute this metric and keep track of its mean since the beginning of the epoch. Most of the time, this is exactly what you want. But not always! Consider a binary classifier's precision, for example. As we saw in [Chapter 3](#), precision is the number of true positives divided by the number of positive predictions (including both true positives and false positives). Suppose the model made 5 positive predictions in the first batch, 4 of which were correct: that's 80% precision. Then suppose the model made 3 positive predictions in the second batch, but they were all incorrect: that's 0% precision for the second batch. If you just compute the mean of these two precisions, you get 40%. But wait a second, this is *not* the model's precision over these two batches! Indeed, there were a total of 4 true positives (4 + 0) out of 8 positive predictions (5 + 3), so the overall precision is 50%, not 40%. What we need is an object that can keep track of the number of true positives and the num-

⁶ However, the Huber loss is seldom used as a metric (the MAE or MSE are preferred).

ber of false positives, and compute their ratio when requested. This is precisely what the `keras.metrics.Precision` class does:

```
>>> precision = keras.metrics.Precision()
>>> precision([0, 1, 1, 1, 0, 1, 0, 1], [1, 1, 0, 1, 0, 1, 0, 1])
<tf.Tensor: id=581729, shape=(), dtype=float32, numpy=0.8>
>>> precision([0, 1, 0, 0, 1, 0, 1, 1], [1, 0, 1, 1, 0, 0, 0, 0])
<tf.Tensor: id=581780, shape=(), dtype=float32, numpy=0.5>
```

In this example, we created a `Precision` object, then we used it like a function, passing it the labels and predictions for the first batch, then for the second batch (note that we could also have passed sample weights). We used the same number of true and false positives as in the example we just discussed. After the first batch, it returns the precision of 80%, then after the second batch it returns 50% (which is the overall precision so far, not the second batch's precision). This is called a *streaming metric* (or *stateful metric*), as it is gradually updated, batch after batch.

At any point, we can call the `result()` method to get the current value of the metric. We can also look at its variables (tracking the number of true and false positives) using the `variables` attribute, and reset these variables using the `reset_states()` method:

```
>>> p.result()
<tf.Tensor: id=581794, shape=(), dtype=float32, numpy=0.5>
>>> p.variables
[<tf.Variable 'true_positives:0' [...] numpy=array([4.], dtype=float32)>,
 <tf.Variable 'false_positives:0' [...] numpy=array([4.], dtype=float32)>]
>>> p.reset_states() # both variables get reset to 0.0
```

If you need to create such a streaming metric, you can just create a subclass of the `keras.metrics.Metric` class. Here is a simple example that keeps track of the total Huber loss and the number of instances seen so far. When asked for the result, it returns the ratio, which is simply the mean Huber loss:

```
class HuberMetric(keras.metrics.Metric):
    def __init__(self, threshold=1.0, **kwargs):
        super().__init__(**kwargs) # handles base args (e.g., dtype)
        self.threshold = threshold
        self.huber_fn = create_huber(threshold)
        self.total = self.add_weight("total", initializer="zeros")
        self.count = self.add_weight("count", initializer="zeros")
    def update_state(self, y_true, y_pred, sample_weight=None):
        metric = self.huber_fn(y_true, y_pred)
        self.total.assign_add(tf.reduce_sum(metric))
        self.count.assign_add(tf.cast(tf.size(y_true), tf.float32))
    def result(self):
        return self.total / self.count
    def get_config(self):
        base_config = super().get_config()
        return {**base_config, "threshold": self.threshold}
```

Let's walk through this code⁷:

- The constructor uses the `add_weight()` method to create the variables needed to keep track of the metric's state over multiple batches, in this case the sum of all Huber losses (`total`) and the number of instances seen so far (`count`). You could just create variables manually if you preferred. Keras tracks any `tf.Variable` that is set as an attribute (and more generally, any "trackable" object, such as layers or models).
- The `update_state()` method is called when you use an instance of this class as a function (as we did with the `Precision` object). It updates the variables given the labels and predictions for one batch (and sample weights, but in this case we just ignore them).
- The `result()` method computes and returns the final result, in this case just the mean Huber metric over all instances. When you use the metric as a function, the `update_state()` method gets called first, then the `result()` method is called, and its output is returned.
- We also implement the `get_config()` method to ensure the `threshold` gets saved along with the model.
- The default implementation of the `reset_states()` method just resets all variables to 0.0 (but you can override it if needed).



Keras will take care of variable persistence seamlessly, no action is required.

When you define a metric using a simple function, Keras automatically calls it for each batch, and it keeps track of the mean during each epoch, just like we did manually. So the only benefit of our `HuberMetric` class is that the `threshold` will be saved. But of course, some metrics, like precision, cannot simply be averaged over batches: in those cases, there's no other option than to implement a streaming metric.

Now that we have built a streaming metric, building a custom layer will seem like a walk in the park!

⁷ This class is for illustration purposes only. A simpler and better implementation would just subclass the `keras.metrics.Mean` class, see the notebook for an example.

Custom Layers

You may occasionally want to build an architecture that contains an exotic layer for which TensorFlow does not provide a default implementation. In this case, you will need to create a custom layer. Or sometimes you may simply want to build a very repetitive architecture, containing identical blocks of layers repeated many times, and it would be convenient to treat each block of layers as a single layer. For example, if the model is a sequence of layers A, B, C, A, B, C, A, B, C, then you might want to define a custom layer D containing layers A, B, C, and your model would then simply be D, D, D. Let's see how to build custom layers.

First, some layers have no weights, such as `keras.layers.Flatten` or `keras.layers.ReLU`. If you want to create a custom layer without any weights, the simplest option is to write a function and wrap it in a `keras.layers.Lambda` layer. For example, the following layer will apply the exponential function to its inputs:

```
exponential_layer = keras.layers.Lambda(lambda x: tf.exp(x))
```

This custom layer can then be used like any other layer, using the sequential API, the functional API, or the subclassing API. You can also use it as an activation function (or you could just use `activation=tf.exp`, or `activation=keras.activations.exponential`, or simply `activation="exponential"`). The exponential layer is sometimes used in the output layer of a regression model when the values to predict have very different scales (e.g., 0.001, 10., 1000.).

As you probably guessed by now, to build a custom stateful layer (i.e., a layer with weights), you need to create a subclass of the `keras.layers.Layer` class. For example, the following class implements a simplified version of the Dense layer:

```
class MyDense(keras.layers.Layer):
    def __init__(self, units, activation=None, **kwargs):
        super().__init__(**kwargs)
        self.units = units
        self.activation = keras.activations.get(activation)

    def build(self, batch_input_shape):
        self.kernel = self.add_weight(
            name="kernel", shape=[batch_input_shape[-1], self.units],
            initializer="glorot_normal")
        self.bias = self.add_weight(
            name="bias", shape=[self.units], initializer="zeros")
        super().build(batch_input_shape) # must be at the end

    def call(self, X):
        return self.activation(X @ self.kernel + self.bias)

    def compute_output_shape(self, batch_input_shape):
        return tf.TensorShape(batch_input_shape.as_list()[:-1] + [self.units])
```

```

def get_config(self):
    base_config = super().get_config()
    return {**base_config, "units": self.units,
            "activation": keras.activations.serialize(self.activation)}

```

Let's walk through this code:

- The constructor takes all the hyperparameters as arguments (in this example just `units` and `activation`), and importantly it also takes a `**kwargs` argument. It calls the parent constructor, passing it the `kwargs`: this takes care of standard arguments such as `input_shape`, `trainable`, `name`, and so on. Then it saves the hyperparameters as attributes, converting the `activation` argument to the appropriate activation function using the `keras.activations.get()` function (it accepts functions, standard strings like `"relu"` or `"selu"`, or simply `None`)⁸.
- The `build()` method's role is to create the layer's variables, by calling the `add_weight()` method for each weight. The `build()` method is called the first time the layer is used. At that point, Keras will know the shape of this layer's inputs, and it will pass it to the `build()` method⁹, which is often necessary to create some of the weights. For example, we need to know the number of neurons in the previous layer in order to create the connection weights matrix (i.e., the `"kernel"`): this corresponds to the size of the last dimension of the inputs. At the end of the `build()` method (and only at the end), you must call the parent's `build()` method: this tells Keras that the layer is built (it just sets `self.built = True`).
- The `call()` method actually performs the desired operations. In this case, we compute the matrix multiplication of the inputs X and the layer's kernel, we add the bias vector, we apply the activation function to the result, and this gives us the output of the layer.
- The `compute_output_shape()` method simply returns the shape of this layer's outputs. In this case, it is the same shape as the inputs, except the last dimension is replaced with the number of neurons in the layer. Note that in `tf.keras`, shapes are instances of the `tf.TensorShape` class, which you can convert to Python lists using `as_list()`.
- The `get_config()` method is just like earlier. Note that we save the activation function's full configuration by calling `keras.activations.serialize()`.

You can now use a `MyDense` layer just like any other layer!

⁸ This function is specific to `tf.keras`. You could use `keras.activations.Activation` instead.

⁹ The Keras API calls this argument `input_shape`, but since it also includes the batch dimension, I prefer to call it `batch_input_shape`. Same for `compute_output_shape()`.



You can generally omit the `compute_output_shape()` method, as `tf.keras` automatically infers the output shape, except when the layer is dynamic (as we will see shortly). In other Keras implementations, this method is either required or by default it assumes the output shape is the same as the input shape.

To create a layer with multiple inputs (e.g., `Concatenate`), the argument to the `call()` method should be a tuple containing all the inputs, and similarly the argument to the `compute_output_shape()` method should be a tuple containing each input's batch shape. To create a layer with multiple outputs, the `call()` method should return the list of outputs, and the `compute_output_shape()` should return the list of batch output shapes (one per output). For example, the following toy layer takes two inputs and returns three outputs:

```
class MyMultiLayer(keras.layers.Layer):
    def call(self, X):
        X1, X2 = X
        return [X1 + X2, X1 * X2, X1 / X2]

    def compute_output_shape(self, batch_input_shape):
        b1, b2 = batch_input_shape
        return [b1, b1, b1] # should probably handle broadcasting rules
```

This layer may now be used like any other layer, but of course only using the functional and subclassing APIs, not the sequential API (which only accepts layers with one input and one output).

If your layer needs to have a different behavior during training and during testing (e.g., if it uses `Dropout` or `BatchNormalization` layers), then you must add a `training` argument to the `call()` method and use this argument to decide what to do. For example, let's create a layer that adds Gaussian noise during training (for regularization), but does nothing during testing (Keras actually has a layer that does the same thing: `keras.layers.GaussianNoise`):

```
class MyGaussianNoise(keras.layers.Layer):
    def __init__(self, stddev, **kwargs):
        super().__init__(**kwargs)
        self.stddev = stddev

    def call(self, X, training=None):
        if training:
            noise = tf.random.normal(tf.shape(X), stddev=self.stddev)
            return X + noise
        else:
            return X

    def compute_output_shape(self, batch_input_shape):
        return batch_input_shape
```

With that, you can now build any custom layer you need! Now let's create custom models.

Custom Models

We already looked at custom model classes in [Chapter 10](#) when we discussed the subclassing API.¹⁰ It is actually quite straightforward, just subclass the `keras.models.Model` class, create layers and variables in the constructor, and implement the `call()` method to do whatever you want the model to do. For example, suppose you want to build the model represented in [Figure 12-3](#):

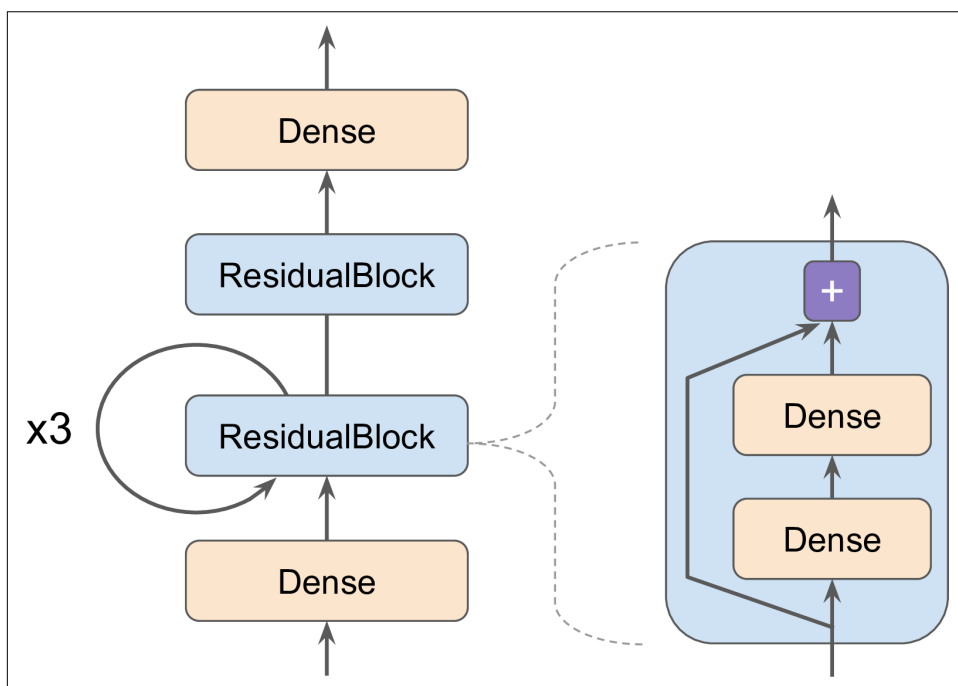

Figure 12-3. Custom Model Example

The inputs go through a first dense layer, then through a *residual block* composed of two dense layers and an addition operation (as we will see in [Chapter 14](#), a residual block adds its inputs to its outputs), then through this same residual block 3 more times, then through a second residual block, and the final result goes through a dense output layer. Note that this model does not make much sense, it's just an example to illustrate the fact that you can easily build any kind of model you want, even contain-

¹⁰ The name “subclassing API” usually refers only to the creation of custom models by subclassing, although many other things can be created by subclassing, as we saw in this chapter.

ing loops and skip connections. To implement this model, it is best to first create a `ResidualBlock` layer, since we are going to create a couple identical blocks (and we might want to reuse it in another model):

```
class ResidualBlock(keras.layers.Layer):
    def __init__(self, n_layers, n_neurons, **kwargs):
        super().__init__(**kwargs)
        self.hidden = [keras.layers.Dense(n_neurons, activation="elu",
                                           kernel_initializer="he_normal")
                       for _ in range(n_layers)]

    def call(self, inputs):
        Z = inputs
        for layer in self.hidden:
            Z = layer(Z)
        return inputs + Z
```

This layer is a bit special since it contains other layers. This is handled transparently by Keras: it automatically detects that the `hidden` attribute contains trackable objects (layers in this case), so their variables are automatically added to this layer's list of variables. The rest of this class is self-explanatory. Next, let's use the subclassing API to define the model itself:

```
class ResidualRegressor(keras.models.Model):
    def __init__(self, output_dim, **kwargs):
        super().__init__(**kwargs)
        self.hidden1 = keras.layers.Dense(30, activation="elu",
                                           kernel_initializer="he_normal")
        self.block1 = ResidualBlock(2, 30)
        self.block2 = ResidualBlock(2, 30)
        self.out = keras.layers.Dense(output_dim)

    def call(self, inputs):
        Z = self.hidden1(inputs)
        for _ in range(1 + 3):
            Z = self.block1(Z)
        Z = self.block2(Z)
        return self.out(Z)
```

We create the layers in the constructor, and use them in the `call()` method. This model can then be used like any other model (compile it, fit it, evaluate it and use it to make predictions). If you also want to be able to save the model using the `save()` method, and load it using the `keras.models.load_model()` function, you must implement the `get_config()` method (as we did earlier) in both the `ResidualBlock` class and the `ResidualRegressor` class. Alternatively, you can just save and load the weights using the `save_weights()` and `load_weights()` methods.

The `Model` class is actually a subclass of the `Layer` class, so models can be defined and used exactly like layers. But a model also has some extra functionalities, including of course its `compile()`, `fit()`, `evaluate()` and `predict()` methods (and a few var-

ients, such as `train_on_batch()` or `fit_generator()`, plus the `get_layers()` method (which can return any of the model's layers by name or by index), and the `save()` method (and support for `keras.models.load_model()` and `keras.models.clone_model()`). So if models provide more functionalities than layers, why not just define every layer as a model? Well, technically you could, but it is probably cleaner to distinguish the internal components of your model (layers or reusable blocks of layers) from the model itself. The former should subclass the `Layer` class, while the latter should subclass the `Model` class.

With that, you can quite naturally and concisely build almost any model that you find in a paper, either using the sequential API, the functional API, the subclassing API, or even a mix of these. "Almost" any model? Yes, there are still a couple things that we need to look at: first, how to define losses or metrics based on model internals, and second how to build a custom training loop.

Losses and Metrics Based on Model Internals

The custom losses and metrics we defined earlier were all based on the labels and the predictions (and optionally sample weights). However, you will occasionally want to define losses based on other parts of your model, such as the weights or activations of its hidden layers. This may be useful for regularization purposes, or to monitor some internal aspect of your model.

To define a custom loss based on model internals, just compute it based on any part of the model you want, then pass the result to the `add_loss()` method. For example, the following custom model represents a standard MLP regressor with 5 hidden layers, except it also implements a *reconstruction loss* (see ???): we add an extra `Dense` layer on top of the last hidden layer, and its role is to try to reconstruct the inputs of the model. Since the reconstruction must have the same shape as the model's inputs, we need to create this `Dense` layer in the `build()` method to have access to the shape of the inputs. In the `call()` method, we compute both the regular output of the MLP, plus the output of the reconstruction layer. We then compute the mean squared difference between the reconstructions and the inputs, and we add this value (times 0.05) to the model's list of losses by calling `add_loss()`. During training, Keras will add this loss to the main loss (which is why we scaled down the reconstruction loss, to ensure the main loss dominates). As a result, the model will be forced to preserve as much information as possible through the hidden layers, even information that is not directly useful for the regression task itself. In practice, this loss sometimes improves generalization; it is a regularization loss:

```
class ReconstructingRegressor(keras.models.Model):
    def __init__(self, output_dim, **kwargs):
        super().__init__(**kwargs)
        self.hidden = [keras.layers.Dense(30, activation="selu",
                                         kernel_initializer="lecun_normal")
```

```

        for _ in range(5)]
self.out = keras.layers.Dense(output_dim)

def build(self, batch_input_shape):
    n_inputs = batch_input_shape[-1]
    self.reconstruct = keras.layers.Dense(n_inputs)
    super().build(batch_input_shape)

def call(self, inputs):
    Z = inputs
    for layer in self.hidden:
        Z = layer(Z)
    reconstruction = self.reconstruct(Z)
    recon_loss = tf.reduce_mean(tf.square(reconstruction - inputs))
    self.add_loss(0.05 * recon_loss)
    return self.out(Z)

```

Similarly, you can add a custom metric based on model internals by computing it in any way you want, as long as the result is the output of a metric object. For example, you can create a `keras.metrics.Mean()` object in the constructor, then call it in the `call()` method, passing it the `recon_loss`, and finally add it to the model by calling the model's `add_metric()` method. This way, when you train the model, Keras will display both the mean loss over each epoch (the loss is the sum of the main loss plus 0.05 times the reconstruction loss) and the mean reconstruction error over each epoch. Both will go down during training:

```

Epoch 1/5
11610/11610 [=====] [...] loss: 4.3092 - reconstruction_error: 1.7360
Epoch 2/5
11610/11610 [=====] [...] loss: 1.1232 - reconstruction_error: 0.8964
[...]

```

In over 99% of the cases, everything we have discussed so far will be sufficient to implement whatever model you want to build, even with complex architectures, losses, metrics, and so on. However, in some rare cases you may need to customize the training loop itself. However, before we get there, we need to look at how to compute gradients automatically in TensorFlow.

Computing Gradients Using Autodiff

To understand how to use autodiff (see [Chapter 10](#) and [???](#)) to compute gradients automatically, let's consider a simple toy function:

```

def f(w1, w2):
    return 3 * w1 ** 2 + 2 * w1 * w2

```

If you know calculus, you can analytically find that the partial derivative of this function with regards to `w1` is `6 * w1 + 2 * w2`. You can also find that its partial derivative with regards to `w2` is `2 * w1`. For example, at the point `(w1, w2) = (5, 3)`, these par-

tial derivatives are equal to 36 and 10, respectively, so the gradient vector at this point is (36, 10). But if this were a neural network, the function would be much more complex, typically with tens of thousands of parameters, and finding the partial derivatives analytically by hand would be an almost impossible task. One solution could be to compute an approximation of each partial derivative by measuring how much the function's output changes when you tweak the corresponding parameter:

```
>>> w1, w2 = 5, 3
>>> eps = 1e-6
>>> (f(w1 + eps, w2) - f(w1, w2)) / eps
36.000003007075065
>>> (f(w1, w2 + eps) - f(w1, w2)) / eps
10.000000003174137
```

Looks about right! This works rather well and it is trivial to implement, but it is just an approximation, and importantly you need to call `f()` at least once per parameter (not twice, since we could compute `f(w1, w2)` just once). This makes this approach intractable for large neural networks. So instead we should use autodiff (see [Chapter 10](#) and [???](#)). TensorFlow makes this pretty simple:

```
w1, w2 = tf.Variable(5.), tf.Variable(3.)
with tf.GradientTape() as tape:
    z = f(w1, w2)

gradients = tape.gradient(z, [w1, w2])
```

We first define two variables `w1` and `w2`, then we create a `tf.GradientTape` context that will automatically record every operation that involves a variable, and finally we ask this tape to compute the gradients of the result `z` with regards to both variables `[w1, w2]`. Let's take a look at the gradients that TensorFlow computed:

```
>>> gradients
[<tf.Tensor: id=828234, shape=(), dtype=float32, numpy=36.0>,
 <tf.Tensor: id=828229, shape=(), dtype=float32, numpy=10.0>]
```

Perfect! Not only is the result accurate (the precision is only limited by the floating point errors), but the `gradient()` method only goes through the recorded computations once (in reverse order), no matter how many variables there are, so it is incredibly efficient. It's like magic!



Only put the strict minimum inside the `tf.GradientTape()` block, to save memory. Alternatively, you can pause recording by creating a `with tape.stop_recording()` block inside the `tf.GradientTape()` block.

The tape is automatically erased immediately after you call its `gradient()` method, so you will get an exception if you try to call `gradient()` twice:

```

with tf.GradientTape() as tape:
    z = f(w1, w2)

dz_dw1 = tape.gradient(z, w1) # => tensor 36.0
dz_dw2 = tape.gradient(z, w2) # RuntimeError!

```

If you need to call `gradient()` more than once, you must make the tape persistent, and delete it when you are done with it to free resources:

```

with tf.GradientTape(persistent=True) as tape:
    z = f(w1, w2)

dz_dw1 = tape.gradient(z, w1) # => tensor 36.0
dz_dw2 = tape.gradient(z, w2) # => tensor 10.0, works fine now!
del tape

```

By default, the tape will only track operations involving variables, so if you try to compute the gradient of `z` with regards to anything else than a variable, the result will be `None`:

```

c1, c2 = tf.constant(5.), tf.constant(3.)
with tf.GradientTape() as tape:
    z = f(c1, c2)

gradients = tape.gradient(z, [c1, c2]) # returns [None, None]

```

However, you can force the tape to watch any tensors you like, to record every operation that involves them. You can then compute gradients with regards to these tensors, as if they were variables:

```

with tf.GradientTape() as tape:
    tape.watch(c1)
    tape.watch(c2)
    z = f(c1, c2)

gradients = tape.gradient(z, [c1, c2]) # returns [tensor 36., tensor 10.]

```

This can be useful in some cases, for example if you want to implement a regularization loss that penalizes activations that vary a lot when the inputs vary little: the loss will be based on the gradient of the activations with regards to the inputs. Since the inputs are not variables, you would need to tell the tape to watch them.

If you compute the gradient of a list of tensors (e.g., `[z1, z2, z3]`) with regards to some variables (e.g., `[w1, w2]`), TensorFlow actually efficiently computes the sum of the gradients of these tensors (i.e., `gradient(z1, [w1, w2])`, plus `gradient(z2, [w1, w2])`, plus `gradient(z3, [w1, w2])`). Due to the way reverse-mode autodiff works, it is not possible to compute the individual gradients (`z1`, `z2` and `z3`) without actually calling `gradient()` multiple times (once for `z1`, once for `z2` and once for `z3`), which requires making the tape persistent (and deleting it afterwards).

Moreover, it is actually possible to compute second order partial derivatives (the Hessians, i.e., the partial derivatives of the partial derivatives)! To do this, we need to record the operations that are performed when computing the first-order partial derivatives (the Jacobians): this requires a second tape. Here is how it works:

```
with tf.GradientTape(persistent=True) as hessian_tape:
    with tf.GradientTape() as jacobian_tape:
        z = f(w1, w2)
        jacobians = jacobian_tape.gradient(z, [w1, w2])
    hessians = [hessian_tape.gradient(jacobian, [w1, w2])
                for jacobian in jacobians]
del hessian_tape
```

The inner tape is used to compute the Jacobians, as we did earlier. The outer tape is used to compute the partial derivatives of each Jacobian. Since we need to call `gradient()` once for each Jacobian (or else we would get the sum of the partial derivatives over all the Jacobians, as explained earlier), we need the outer tape to be persistent, so we delete it at the end. The Jacobians are obviously the same as earlier (36 and 5), but now we also have the Hessians:

```
>>> hessians # dz_dw1_dw1, dz_dw1_dw2, dz_dw2_dw1, dz_dw2_dw2
[[<tf.Tensor: id=830578, shape=(), dtype=float32, numpy=6.0>,
  <tf.Tensor: id=830595, shape=(), dtype=float32, numpy=2.0>],
 [<tf.Tensor: id=830600, shape=(), dtype=float32, numpy=2.0>, None]]
```

Let's verify these Hessians. The first two are the partial derivatives of $6 * w1 + 2 * w2$ (which is, as we saw earlier, the partial derivative of f with regards to $w1$), with regards to $w1$ and $w2$. The result is correct: 6 for $w1$ and 2 for $w2$. The next two are the partial derivatives of $2 * w1$ (the partial derivative of f with regards to $w2$), with regards to $w1$ and $w2$, which are 2 for $w1$ and 0 for $w2$. Note that TensorFlow returns `None` instead of 0 since $w2$ does not appear at all in $2 * w1$. TensorFlow also returns `None` when you use an operation whose gradients are not defined (e.g., `tf.argmax()`).

In some rare cases you may want to stop gradients from backpropagating through some part of your neural network. To do this, you must use the `tf.stop_gradient()` function: it just returns its inputs during the forward pass (like `tf.identity()`), but it does not let gradients through during backpropagation (it acts like a constant). For example:

```
def f(w1, w2):
    return 3 * w1 ** 2 + tf.stop_gradient(2 * w1 * w2)

with tf.GradientTape() as tape:
    z = f(w1, w2) # same result as without stop_gradient()

gradients = tape.gradient(z, [w1, w2]) # => returns [tensor 30., None]
```

Finally, you may occasionally run into some numerical issues when computing gradients. For example, if you compute the gradients of the `my_softplus()` function for large inputs, the result will be NaN:

```
>>> x = tf.Variable([100.])
>>> with tf.GradientTape() as tape:
...     z = my_softplus(x)
...
>>> tape.gradient(z, [x])
<tf.Tensor: [...] numpy=array([nan], dtype=float32)>
```

This is because computing the gradients of this function using autodiff leads to some numerical difficulties: due to floating point precision errors, autodiff ends up computing infinity divided by infinity (which returns NaN). Fortunately, we can analytically find that the derivative of the softplus function is just $1 / (1 + 1 / \exp(x))$, which is numerically stable. Next, we can tell TensorFlow to use this stable function when computing the gradients of the `my_softplus()` function, by decorating it with `@tf.custom_gradient`, and making it return both its normal output and the function that computes the derivatives (note that it will receive as input the gradients that were backpropagated so far, down to the softplus function, and according to the chain rule we should multiply them with this function's gradients):

```
@tf.custom_gradient
def my_better_softplus(z):
    exp = tf.exp(z)
    def my_softplus_gradients(grad):
        return grad / (1 + 1 / exp)
    return tf.math.log(exp + 1), my_softplus_gradients
```

Now when we compute the gradients of the `my_better_softplus()` function, we get the proper result, even for large input values (however, the main output still explodes because of the exponential: one workaround is to use `tf.where()` to just return the inputs when they are large).

Congratulations! You can now compute the gradients of any function (provided it is differentiable at the point where you compute it), you can even compute Hessians, block backpropagation when needed and even write your own gradient functions! This is probably more flexibility than you will ever need, even if you build your own custom training loops, as we will see now.

Custom Training Loops

In some rare cases, the `fit()` method may not be flexible enough for what you need to do. For example, the Wide and Deep paper we discussed in [Chapter 10](#) actually uses two different optimizers: one for the wide path and the other for the deep path. Since the `fit()` method only uses one optimizer (the one that we specify when

compiling the model), implementing this paper requires writing your own custom loop.

You may also like to write your own custom training loops simply to feel more confident that it does precisely what you intend it to do (perhaps you are unsure about some details of the `fit()` method). It can sometimes feel safer to make everything explicit. However, remember that writing a custom training loop will make your code longer, more error prone and harder to maintain.



Unless you really need the extra flexibility, you should prefer using the `fit()` method rather than implementing your own training loop, especially if you work in a team.

First, let's build a simple model. No need to compile it, since we will handle the training loop manually:

```
l2_reg = keras.regularizers.l2(0.05)
model = keras.models.Sequential([
    keras.layers.Dense(30, activation="elu", kernel_initializer="he_normal",
                        kernel_regularizer=l2_reg),
    keras.layers.Dense(1, kernel_regularizer=l2_reg)
])
```

Next, let's create a tiny function that will randomly sample a batch of instances from the training set (in [Chapter 13](#) we will discuss the Data API, which offers a much better alternative):

```
def random_batch(X, y, batch_size=32):
    idx = np.random.randint(len(X), size=batch_size)
    return X[idx], y[idx]
```

Let's also define a function that will display the training status, including the number of steps, the total number of steps, the mean loss since the start of the epoch (i.e., we will use the Mean metric to compute it), and other metrics:

```
def print_status_bar(iteration, total, loss, metrics=None):
    metrics = " - ".join(["{}: {:.4f}".format(m.name, m.result())
                          for m in [loss] + (metrics or [])])
    end = "" if iteration < total else "\n"
    print("\r{}/{} - ".format(iteration, total) + metrics,
          end=end)
```

This code is self-explanatory, unless you are unfamiliar with Python string formatting: `{:.4f}` will format a float with 4 digits after the decimal point. Moreover, using `\r` (carriage return) along with `end=""` ensures that the status bar always gets printed on the same line. In the notebook, the `print_status_bar()` function also includes a progress bar, but you could use the handy `tqdm` library instead.

With that, let's get down to business! First, we need to define some hyperparameters, choose the optimizer, the loss function and the metrics (just the MAE in this example):

```
n_epochs = 5
batch_size = 32
n_steps = len(X_train) // batch_size
optimizer = keras.optimizers.Nadam(lr=0.01)
loss_fn = keras.losses.mean_squared_error
mean_loss = keras.metrics.Mean()
metrics = [keras.metrics.MeanAbsoluteError()]
```

And now we are ready to build the custom loop!

```
for epoch in range(1, n_epochs + 1):
    print("Epoch {}/{}".format(epoch, n_epochs))
    for step in range(1, n_steps + 1):
        X_batch, y_batch = random_batch(X_train_scaled, y_train)
        with tf.GradientTape() as tape:
            y_pred = model(X_batch, training=True)
            main_loss = tf.reduce_mean(loss_fn(y_batch, y_pred))
            loss = tf.add_n([main_loss] + model.losses)
            gradients = tape.gradient(loss, model.trainable_variables)
            optimizer.apply_gradients(zip(gradients, model.trainable_variables))
            mean_loss(loss)
        for metric in metrics:
            metric(y_batch, y_pred)
        print_status_bar(step * batch_size, len(y_train), mean_loss, metrics)
    print_status_bar(len(y_train), len(y_train), mean_loss, metrics)
    for metric in [mean_loss] + metrics:
        metric.reset_states()
```

There's a lot going on in this code, so let's walk through it:

- We create two nested loops: one for the epochs, the other for the batches within an epoch.
- Then we sample a random batch from the training set.
- Inside the `tf.GradientTape()` block, we make a prediction for one batch (using the model as a function), and we compute the loss: it is equal to the main loss plus the other losses (in this model, there is one regularization loss per layer). Since the `mean_squared_error()` function returns one loss per instance, we compute the mean over the batch using `tf.reduce_mean()` (if you wanted to apply different weights to each instance, this is where you would do it). The regularization losses are already reduced to a single scalar each, so we just need to sum them (using `tf.add_n()`, which sums multiple tensors of the same shape and data type).

- Next, we ask the `tape` to compute the gradient of the loss with regards to each trainable variable (*not* all variables!), and we apply them to the optimizer to perform a Gradient Descent step.
- Next we update the mean loss and the metrics (over the current epoch), and we display the status bar.
- At the end of each epoch, we display the status bar again to make it look complete¹¹ and to print a line feed, and we reset the states of the mean loss and the metrics.

If you set the optimizer's `clipnorm` or `clipvalue` hyperparameters, it will take care of this for you. If you want to apply any other transformation to the gradients, simply do so before calling the `apply_gradients()` method.

If you add weight constraints to your model (e.g., by setting `kernel_constraint` or `bias_constraint` when creating a layer), you should update the training loop to apply these constraints just after `apply_gradients()`:

```
for variable in model.variables:
    if variable.constraint is not None:
        variable.assign(variable.constraint(variable))
```

Most importantly, this training loop does not handle layers that behave differently during training and testing (e.g., `BatchNormalization` or `Dropout`). To handle these, you need to call the model with `training=True` and make sure it propagates this to every layer that needs it.¹²

As you can see, there are quite a lot of things you need to get right, it is easy to make a mistake. But on the bright side, you get full control, so it's your call.

Now that you know how to customize any part of your models¹³ and training algorithms, let's see how you can use TensorFlow's automatic graph generation feature: it can speed up your custom code considerably, and it will also make it portable to any platform supported by TensorFlow (see ???).

TensorFlow Functions and Graphs

In TensorFlow 1, graphs were unavoidable (as were the complexities that came with them): they were a central part of TensorFlow's API. In TensorFlow 2, they are still

11 The truth is we did not process every single instance in the training set because we sampled instances randomly, so some were processed more than once while others were not processed at all. In practice that's fine. Moreover, if the training set size is not a multiple of the batch size, we will miss a few instances.

12 Alternatively, check out `K.learning_phase()`, `K.set_learning_phase()` and `K.learning_phase_scope()`.

13 With the exception of optimizers, as very few people ever customize these: see the notebook for an example.

there, but not as central, and much (much!) simpler to use. To demonstrate this, let's start with a trivial function that just computes the cube of its input:

```
def cube(x):  
    return x ** 3
```

We can obviously call this function with a Python value, such as an int or a float, or we can call it with a tensor:

```
>>> cube(2)  
8  
>>> cube(tf.constant(2.0))  
<tf.Tensor: id=18634148, shape=(), dtype=float32, numpy=8.0>
```

Now, let's use `tf.function()` to convert this Python function to a *TensorFlow Function*:

```
>>> tf_cube = tf.function(cube)  
>>> tf_cube  
<tensorflow.python.eager.def_function.Function at 0x1546fc080>
```

This TF Function can then be used exactly like the original Python function, and it will return the same result (but as tensors):

```
>>> tf_cube(2)  
<tf.Tensor: id=18634201, shape=(), dtype=int32, numpy=8>  
>>> tf_cube(tf.constant(2.0))  
<tf.Tensor: id=18634211, shape=(), dtype=float32, numpy=8.0>
```

Under the hood, `tf.function()` analyzed the computations performed by the `cube()` function and generated an equivalent computation graph! As you can see, it was rather painless (we will see how this works shortly). Alternatively, we could have used `tf.function` as a decorator; this is actually more common:

```
@tf.function  
def tf_cube(x):  
    return x ** 3
```

The original Python function is still available via the TF Function's `python_function` attribute, in case you ever need it:

```
>>> tf_cube.python_function(2)  
8
```

TensorFlow optimizes the computation graph, pruning unused nodes, simplifying expressions (e.g., `1 + 2` would get replaced with `3`), and more. Once the optimized graph is ready, the TF Function efficiently executes the operations in the graph, in the appropriate order (and in parallel when it can). As a result, a TF Function will usually run much faster than the original Python function, especially if it performs complex

computations.¹⁴ Most of the time you will not really need to know more than that: when you want to boost a Python function, just transform it into a TF Function. That's all!

Moreover, when you write a custom loss function, a custom metric, a custom layer or any other custom function, and you use it in a Keras model (as we did throughout this chapter), Keras automatically converts your function into a TF Function, no need to use `tf.function()`. So most of the time, all this magic is 100% transparent.



You can tell Keras *not* to convert your Python functions to TF Functions by setting `dynamic=True` when creating a custom layer or a custom model. Alternatively, you can set `run_eagerly=True` when calling the model's `compile()` method.

TF Function generates a new graph for every unique set of input shapes and data types, and it caches it for subsequent calls. For example, if you call `tf_cube(tf.constant(10))`, a graph will be generated for int32 tensors of shape `[]`. Then if you call `tf_cube(tf.constant(20))`, the same graph will be reused. But if you then call `tf_cube(tf.constant([10, 20]))`, a new graph will be generated for int32 tensors of shape `[2]`. This is how TF Functions handle polymorphism (i.e., varying argument types and shapes). However, this is only true for tensor arguments: if you pass numerical Python values to a TF Function, a new graph will be generated for every distinct value: for example, calling `tf_cube(10)` and `tf_cube(20)` will generate two graphs.



If you call a TF Function many times with different numerical Python values, then many graphs will be generated, slowing down your program and using up a lot of RAM. Python values should be reserved for arguments that will have few unique values, such as hyperparameters like the number of neurons per layer. This allows TensorFlow to better optimize each variant of your model.

Autograph and Tracing

So how does TensorFlow generate graphs? Well, first it starts by analyzing the Python function's source code to capture all the control flow statements, such as for loops and while loops, if statements, as well as `break`, `continue` and `return` statements. This first step is called *autograph*. The reason TensorFlow has to analyze the source code is that Python does not provide any other way to capture control flow statements: it offers magic methods like `__add__()` or `__mul__()` to capture operators like

¹⁴ However, in this trivial example, the computation graph is so small that there is nothing at all to optimize, so `tf_cube()` actually runs much slower than `cube()`.

+ and *, but there are no `__while__()` or `__if__()` magic methods. After analyzing the function’s code, autograph outputs an upgraded version of that function in which all the control flow statements are replaced by the appropriate TensorFlow operations, such as `tf.while_loop()` for loops and `tf.cond()` for if statements. For example, in [Figure 12-4](#), autograph analyzes the source code of the `sum_squares()` Python function, and it generates the `tf__sum_squares()` function. In this function, the for loop is replaced by the definition of the `loop_body()` function (containing the body of the original for loop), followed by a call to the `for_stmt()` function. This call will build the appropriate `tf.while_loop()` operation in the computation graph.

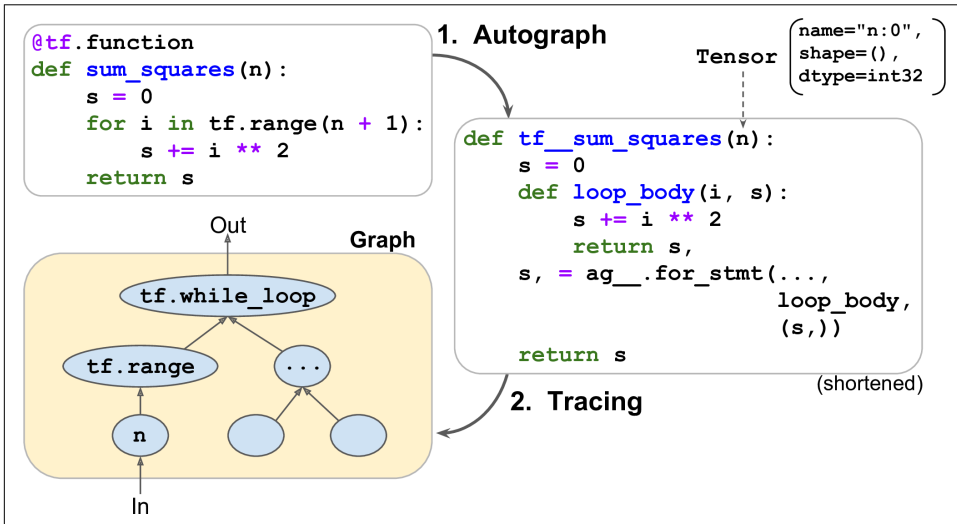

Figure 12-4. How TensorFlow generates graphs using autograph and tracing

Next, TensorFlow calls this “upgraded” function, but instead of passing the actual argument, it passes a *symbolic tensor*, meaning a tensor without any actual value, only a name, a data type, and a shape. For example, if you call `sum_squares(tf.constant(10))`, then the `tf__sum_squares()` function will actually be called with a symbolic tensor of type `int32` and shape `[]`. The function will run in *graph mode*, meaning that each TensorFlow operation will just add a node in the graph to represent itself and its output tensor(s) (as opposed to the regular mode, called *eager execution*, or *eager mode*). In graph mode, TF operations do not perform any actual computations. This should feel familiar if you know TensorFlow 1, as graph mode was the default mode. In [Figure 12-4](#), you can see the `tf__sum_squares()` function being called with a symbolic tensor as argument (in this case, an `int32` tensor of shape `[]`), and the final graph generated during tracing. The ellipses represent operations, and the arrows represent tensors (both the generated function and the graph are simplified).



To view the generated function's source code, you can call `tf.auto_graph.to_code(sum_squares.python_function)`. The code is not meant to be pretty, but it can sometimes help for debugging.

TF Function Rules

Most of the time, converting a Python function that performs TensorFlow operations into a TF Function is trivial: just decorate it with `@tf.function` or let Keras take care of it for you. However, there are a few rules to respect:

- If you call any external library, including NumPy or even the standard library, this call will run only during tracing, it will not be part of the graph. Indeed, a TensorFlow graph can only include TensorFlow constructs (tensors, operations, variables, datasets, and so on). So make sure you use `tf.reduce_sum()` instead of `np.sum()`, and `tf.sort()` instead of the built-in `sorted()` function, and so on (unless you really want the code to run only during tracing).
 - For example, if you define a TF function `f(x)` that just returns `np.random.rand()`, a random number will only be generated when the function is traced, so `f(tf.constant(2.))` and `f(tf.constant(3.))` will return the same random number, but `f(tf.constant([2., 3.]))` will return a different one. If you replace `np.random.rand()` with `tf.random.uniform([])`, then a new random number will be generated upon every call, since the operation will be part of the graph.
 - If your non-TensorFlow code has side-effects (such as logging something or updating a Python counter), then you should not expect that side-effect to occur every time you call the TF Function, as it will only occur when the function is traced.
 - You can wrap arbitrary Python code in a `tf.py_function()` operation, but this will hinder performance, as TensorFlow will not be able to do any graph optimization on this code, and it will also reduce portability, as the graph will only run on platforms where Python is available (and the right libraries installed).
- You can call other Python functions or TF Functions, but they should follow the same rules, as TensorFlow will also capture their operations in the computation graph. Note that these other functions do not need to be decorated with `@tf.function`.
- If the function creates a TensorFlow variable (or any other stateful TensorFlow object, such as a dataset or a queue), it must do so upon the very first call, and only then, or else you will get an exception. It is usually preferable to create variables outside of the TF Function (e.g., in the `build()` method of a custom layer).

- The source code of your Python function should be available to TensorFlow. If the source code is unavailable (for example, if you define your function in the Python shell, which does not give access to the source code, or if you deploy only the compiled Python files *.pyc to production), then the graph generation process will fail or have limited functionality.
- TensorFlow will only capture for loops that iterate over a tensor or a Dataset. So make sure you use `for i in tf.range(10)` rather than `for i in range(10)`, or else the loop will not be captured in the graph. Instead, it will run during tracing. This may be what you want, if the for loop is meant to build the graph, for example to create each layer in a neural network.
- And as always, for performance reasons, you should prefer a vectorized implementation whenever you can, rather than using loops.

It's time to sum up! In this chapter we started with a brief overview of TensorFlow, then we looked at TensorFlow's low-level API, including tensors, operations, variables and special data structures. We then used these tools to customize almost every component in `tf.keras`. Finally, we looked at how TF Functions can boost performance, how graphs are generated using autograph and tracing, and what rules to follow when you write TF Functions (if you would like to open the black box a bit further, for example to explore the generated graphs, you will find further technical details in [???](#)).

In the next chapter, we will look at how to efficiently load and preprocess data with TensorFlow.

Loading and Preprocessing Data with TensorFlow



With Early Release ebooks, you get books in their earliest form—the author’s raw and unedited content as he or she writes—so you can take advantage of these technologies long before the official release of these titles. The following will be Chapter 13 in the final release of the book.

So far we have used only datasets that fit in memory, but Deep Learning systems are often trained on very large datasets that will not fit in RAM. Ingesting a large dataset and preprocessing it efficiently can be tricky to implement with other Deep Learning libraries, but TensorFlow makes it easy thanks to the *Data API*: you just create a dataset object, tell it where to get the data, then transform it in any way you want, and TensorFlow takes care of all the implementation details, such as multithreading, queuing, batching, prefetching, and so on.

Off the shelf, the Data API can read from text files (such as CSV files), binary files with fixed-size records, and binary files that use TensorFlow’s TFRecord format, which supports records of varying sizes. TFRecord is a flexible and efficient binary format based on Protocol Buffers (an open source binary format). The Data API also has support for reading from SQL databases. Moreover, many Open Source extensions are available to read from all sorts of data sources, such as Google’s BigQuery service.

However, reading huge datasets efficiently is not the only difficulty: the data also needs to be preprocessed. Indeed, it is not always composed strictly of convenient numerical fields: sometimes there will be text features, categorical features, and so on. To handle this, TensorFlow provides the *Features API*: it lets you easily convert these features to numerical features that can be consumed by your neural network. For

example, categorical features with a large number of categories (such as cities, or words) can be encoded using *embeddings* (as we will see, an embedding is a trainable dense vector that represents a category).



Both the Data API and the Features API work seamlessly with `tf.keras`.

In this chapter, we will cover the Data API, the TFRecord format and the Features API in detail. We will also take a quick look at a few related projects from TensorFlow's ecosystem:

- TF Transform (*tf.Transform*) makes it possible to write a single preprocessing function that can be run both in batch mode on your full training set, before training (to speed it up), and then exported to a TF Function and incorporated into your trained model, so that once it is deployed in production, it can take care of preprocessing new instances on the fly.
- TF Datasets (TFDS) provides a convenient function to download many common datasets of all kinds, including large ones like ImageNet, and it provides convenient dataset objects to manipulate them using the Data API.

So let's get started!

The Data API

The whole Data API revolves around the concept of a *dataset*: as you might suspect, this represents a sequence of data items. Usually you will use datasets that gradually read data from disk, but for simplicity let's just create a dataset entirely in RAM using `tf.data.Dataset.from_tensor_slices()`:

```
>>> X = tf.range(10) # any data tensor
>>> dataset = tf.data.Dataset.from_tensor_slices(X)
>>> dataset
<TensorSliceDataset shapes: (), types: tf.int32>
```

The `from_tensor_slices()` function takes a tensor and creates a `tf.data.Dataset` whose elements are all the slices of `X` (along the first dimension), so this dataset contains 10 items: tensors 0, 1, 2, ..., 9. In this case we would have obtained the same dataset if we had used `tf.data.Dataset.range(10)`.

You can simply iterate over a dataset's items like this:

```
>>> for item in dataset:
...     print(item)
```

```

...
tf.Tensor(0, shape=(), dtype=int32)
tf.Tensor(1, shape=(), dtype=int32)
tf.Tensor(2, shape=(), dtype=int32)
[...]
tf.Tensor(9, shape=(), dtype=int32)

```

Chaining Transformations

Once you have a dataset, you can apply all sorts of transformations to it by calling its transformation methods. Each method returns a new dataset, so you can chain transformations like this (this chain is illustrated in [Figure 13-1](#)):

```

>>> dataset = dataset.repeat(3).batch(7)
>>> for item in dataset:
...     print(item)
...
tf.Tensor([0 1 2 3 4 5 6], shape=(7,), dtype=int32)
tf.Tensor([7 8 9 0 1 2 3], shape=(7,), dtype=int32)
tf.Tensor([4 5 6 7 8 9 0], shape=(7,), dtype=int32)
tf.Tensor([1 2 3 4 5 6 7], shape=(7,), dtype=int32)
tf.Tensor([8 9], shape=(2,), dtype=int32)

```

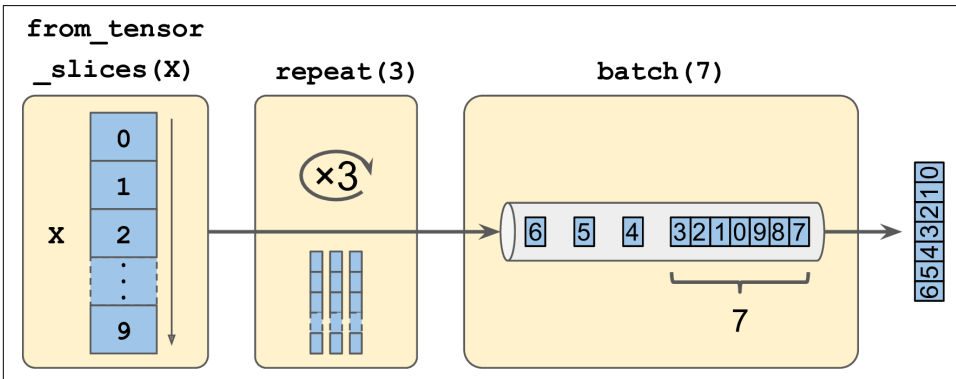

Figure 13-1. Chaining Dataset Transformations

In this example, we first call the `repeat()` method on the original dataset, and it returns a new dataset that will repeat the items of the original dataset 3 times. Of course, this will not copy the whole data in memory 3 times! In fact, if you call this method with no arguments, the new dataset will repeat the source dataset forever. Then we call the `batch()` method on this new dataset, and again this creates a new dataset. This one will group the items of the previous dataset in batches of 7 items. Finally, we iterate over the items of this final dataset. As you can see, the `batch()` method had to output a final batch of size 2 instead of 7, but you can call it with `drop_remainder=True` if you want it to drop this final batch so that all batches have the exact same size.



The dataset methods do *not* modify datasets, they create new ones, so make sure to keep a reference to these new datasets (e.g., `dataset = ...`), or else nothing will happen.

You can also apply any transformation you want to the items by calling the `map()` method. For example, this creates a new dataset with all items doubled:

```
>>> dataset = dataset.map(lambda x: x * 2) # Items: [0,2,4,6,8,10,12]
```

This function is the one you will call to apply any preprocessing you want to your data. Sometimes, this will include computations that can be quite intensive, such as reshaping or rotating an image, so you will usually want to spawn multiple threads to speed things up: it's as simple as setting the `num_parallel_calls` argument.

While the `map()` applies a transformation to each item, the `apply()` method applies a transformation to the dataset as a whole. For example, the following code “unbatches” the dataset, by applying the `unbatch()` function to the dataset (this function is currently experimental, but it will most likely move to the core API in a future release). Each item in the new dataset will be a single integer tensor instead of a batch of 7 integers:

```
>>> dataset = dataset.apply(tf.data.experimental.unbatch()) # Items: 0,2,4,...
```

It is also possible to simply filter the dataset using the `filter()` method:

```
>>> dataset = dataset.filter(lambda x: x < 10) # Items: 0 2 4 6 8 0 2 4 6...
```

You will often want to look at just a few items from a dataset. You can use the `take()` method for that:

```
>>> for item in dataset.take(3):  
...     print(item)  
...  
tf.Tensor(0, shape=(), dtype=int64)  
tf.Tensor(2, shape=(), dtype=int64)  
tf.Tensor(4, shape=(), dtype=int64)
```

Shuffling the Data

As you know, Gradient Descent works best when the instances in the training set are independent and identically distributed (see [Chapter 4](#)). A simple way to ensure this is to shuffle the instances. For this, you can just use the `shuffle()` method. It will create a new dataset that will start by filling up a buffer with the first items of the source dataset, then whenever it is asked for an item, it will pull one out randomly from the buffer, and replace it with a fresh one from the source dataset, until it has iterated entirely through the source dataset. At this point it continues to pull out items randomly from the buffer until it is empty. You must specify the buffer size, and

it is important to make it large enough or else shuffling will not be very efficient.¹ However, obviously do not exceed the amount of RAM you have, and even if you have plenty of it, there's no need to go well beyond the dataset's size. You can provide a random seed if you want the same random order every time you run your program.

```
>>> dataset = tf.data.Dataset.range(10).repeat(3) # 0 to 9, three times
>>> dataset = dataset.shuffle(buffer_size=5, seed=42).batch(7)
>>> for item in dataset:
...     print(item)
...
tf.Tensor([0 2 3 6 7 9 4], shape=(7,), dtype=int64)
tf.Tensor([5 0 1 1 8 6 5], shape=(7,), dtype=int64)
tf.Tensor([4 8 7 1 2 3 0], shape=(7,), dtype=int64)
tf.Tensor([5 4 2 7 8 9 9], shape=(7,), dtype=int64)
tf.Tensor([3 6], shape=(2,), dtype=int64)
```



If you call `repeat()` on a shuffled dataset, by default it will generate a new order at every iteration. This is generally a good idea, but if you prefer to reuse the same order at each iteration (e.g., for tests or debugging), you can set `reshuffle_each_iteration=False`.

For a large dataset that does not fit in memory, this simple shuffling-buffer approach may not be sufficient, since the buffer will be small compared to the dataset. One solution is to shuffle the source data itself (for example, on Linux you can shuffle text files using the `shuf` command). This will definitely improve shuffling a lot! However, even if the source data is shuffled, you will usually want to shuffle it some more, or else the same order will be repeated at each epoch, and the model may end up being biased (e.g., due to some spurious patterns present by chance in the source data's order). To shuffle the instances some more, a common approach is to split the source data into multiple files, then read them in a random order during training. However, instances located in the same file will still end up close to each other. To avoid this you can pick multiple files randomly, and read them simultaneously, interleaving their lines. Then on top of that you can add a shuffling buffer using the `shuffle()` method. If all this sounds like a lot of work, don't worry: the Data API actually makes all this possible in just a few lines of code. Let's see how to do this.

¹ Imagine a sorted deck of cards on your left: suppose you just take the top 3 cards and shuffle them, then pick one randomly and put it to your right, keeping the other 2 in your hands. Take another card on your left, shuffle the 3 cards in your hands and pick one of them randomly, and put it on your right. When you are done going through all the cards like this, you will have a deck of cards on your right: do you think it will be perfectly shuffled?

Interleaving Lines From Multiple Files

First, let's suppose that you loaded the California housing dataset, you shuffled it (unless it was already shuffled), you split it into a training set, a validation set and a test set, then you split each set into many CSV files that each look like this (each row contains 8 input features plus the target median house value):

```
MedInc,HouseAge,AveRooms,AveBedrms,Popul,AveOccup,Lat,Long,MedianHouseValue
3.5214,15.0,3.0499,1.1065,1447.0,1.6059,37.63,-122.43,1.442
5.3275,5.0,6.4900,0.9910,3464.0,3.4433,33.69,-117.39,1.687
3.1,29.0,7.5423,1.5915,1328.0,2.2508,38.44,-122.98,1.621
[...]
```

Let's also suppose `train_filepaths` contains the list of file paths (and you also have `valid_filepaths` and `test_filepaths`):

```
>>> train_filepaths
['datasets/housing/my_train_00.csv', 'datasets/housing/my_train_01.csv',...]
```

Now let's create a dataset containing only these file paths:

```
filepath_dataset = tf.data.Dataset.list_files(train_filepaths, seed=42)
```

By default, the `list_files()` function returns a dataset that shuffles the file paths. In general this is a good thing, but you can set `shuffle=False` if you do not want that, for some reason.

Next, we can call the `interleave()` method to read from 5 files at a time and interleave their lines (skipping the first line of each file, which is the header row, using the `skip()` method):

```
n_readers = 5
dataset = filepath_dataset.interleave(
    lambda filepath: tf.data.TextLineDataset(filepath).skip(1),
    cycle_length=n_readers)
```

The `interleave()` method will create a dataset that will pull 5 file paths from the `filepath_dataset`, and for each one it will call the function we gave it (a lambda in this example) to create a new dataset, in this case a `TextLineDataset`. It will then cycle through these 5 datasets, reading one line at a time from each until all datasets are out of items. Then it will get the next 5 file paths from the `filepath_dataset`, and interleave them the same way, and so on until it runs out of file paths.



For interleaving to work best, it is preferable to have files of identical length, or else the end of the longest files will not be interleaved.

By default, `interleave()` does not use parallelism, it just reads one line at a time from each file, sequentially. However, if you want it to actually read files in parallel, you can set the `num_parallel_calls` argument to the number of threads you want. You can even set it to `tf.data.experimental.AUTOTUNE` to make TensorFlow choose the right number of threads dynamically based on the available CPU (however, this is an experimental feature for now). Let's look at what the dataset contains now:

```
>>> for line in dataset.take(5):
...     print(line.numpy())
...
b'4.2083,44.0,5.3232,0.9171,846.0,2.3370,37.47,-122.2,2.782'
b'4.1812,52.0,5.7013,0.9965,692.0,2.4027,33.73,-118.31,3.215'
b'3.6875,44.0,4.5244,0.9930,457.0,3.1958,34.04,-118.15,1.625'
b'3.3456,37.0,4.5140,0.9084,458.0,3.2253,36.67,-121.7,2.526'
b'3.5214,15.0,3.0499,1.1065,1447.0,1.6059,37.63,-122.43,1.442'
```

These are the first rows (ignoring the header row) of 5 CSV files, chosen randomly. Looks good! But as you can see, these are just byte strings, we need to parse them, and also scale the data.

Preprocessing the Data

Let's implement a small function that will perform this preprocessing:

```
X_mean, X_std = [...] # mean and scale of each feature in the training set
n_inputs = 8

def preprocess(line):
    defs = [0.] * n_inputs + [tf.constant([], dtype=tf.float32)]
    fields = tf.io.decode_csv(line, record_defaults=defs)
    x = tf.stack(fields[:-1])
    y = tf.stack(fields[-1:])
    return (x - X_mean) / X_std, y
```

Let's walk through this code:

- First, we assume that you have precomputed the mean and standard deviation of each feature in the training set. `X_mean` and `X_std` are just 1D tensors (or NumPy arrays) containing 8 floats, one per input feature.
- The `preprocess()` function takes one CSV line, and starts by parsing it. For this, it uses the `tf.io.decode_csv()` function, which takes two arguments: the first is the line to parse, and the second is an array containing the default value for each column in the CSV file. This tells TensorFlow not only the default value for each column, but also the number of columns and the type of each column. In this example, we tell it that all feature columns are floats and missing values should default to 0, but we provide an empty array of type `tf.float32` as the default value for the last column (the target): this tells TensorFlow that this column con-

tains floats, but that there is no default value, so it will raise an exception if it encounters a missing value.

- The `decode_csv()` function returns a list of scalar tensors (one per column) but we need to return 1D tensor arrays. So we call `tf.stack()` on all tensors except for the last one (the target): this will stack these tensors into a 1D array. We then do the same for the target value (this makes it a 1D tensor array with a single value, rather than a scalar tensor).
- Finally, we scale the input features by subtracting the feature means and then dividing by the feature standard deviations, and we return a tuple containing the scaled features and the target.

Let's test this preprocessing function:

```
>>> preprocess(b'4.2083,44.0,5.3232,0.9171,846.0,2.3370,37.47,-122.2,2.782')
(<tf.Tensor: id=6227, shape=(8,), dtype=float32, numpy=
 array([ 0.16579159,  1.216324 , -0.05204564, -0.39215982, -0.5277444 ,
        -0.2633488 ,  0.8543046 , -1.3072058 ], dtype=float32)>,
 <tf.Tensor: [...], numpy=array([2.782]), dtype=float32)>)
```

We can now apply this preprocessing function to the dataset.

Putting Everything Together

To make the code reusable, let's put together everything we have discussed so far into a small helper function: it will create and return a dataset that will efficiently load California housing data from multiple CSV files, then shuffle it, preprocess it and batch it (see [Figure 13-2](#)):

```
def csv_reader_dataset(filepaths, repeat=None, n_readers=5,
                       n_read_threads=None, shuffle_buffer_size=10000,
                       n_parse_threads=5, batch_size=32):
    dataset = tf.data.Dataset.list_files(filepaths).repeat(repeat)
    dataset = dataset.interleave(
        lambda filepath: tf.data.TextLineDataset(filepath).skip(1),
        cycle_length=n_readers, num_parallel_calls=n_read_threads)
    dataset = dataset.shuffle(shuffle_buffer_size)
    dataset = dataset.map(preprocess, num_parallel_calls=n_parse_threads)
    dataset = dataset.batch(batch_size)
    return dataset.prefetch(1)
```

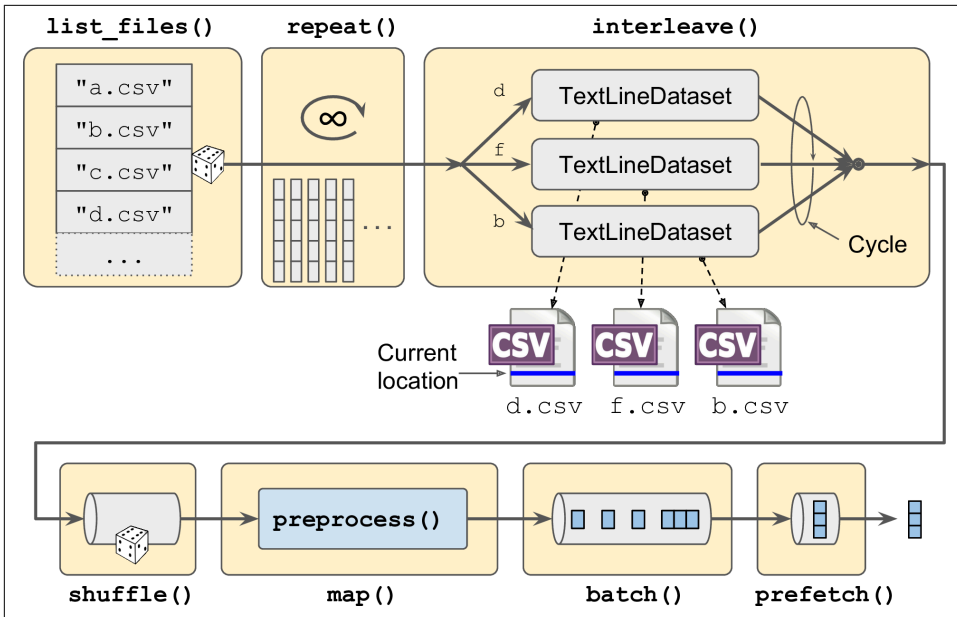

Figure 13-2. Loading and Preprocessing Data From Multiple CSV Files

Everything should make sense in this code, except the very last line (`prefetch(1)`), which is actually quite important for performance.

Prefetching

By calling `prefetch(1)` at the end, we are creating a dataset that will do its best to always be one batch ahead². In other words, while our training algorithm is working on one batch, the dataset will already be working in parallel on getting the next batch ready. This can improve performance dramatically, as is illustrated on [Figure 13-3](#). If we also ensure that loading and preprocessing are multithreaded (by setting `num_parallel_calls` when calling `interleave()` and `map()`), we can exploit multiple cores on the CPU and hopefully make preparing one batch of data shorter than running a training step on the GPU: this way the GPU will be almost 100% utilized (except for the data transfer time from the CPU to the GPU), and training will run much faster.

² In general, just prefetching one batch is fine, but in some cases you may need to prefetch a few more. Alternatively, you can let TensorFlow decide automatically by passing `tf.data.experimental.AUTOTUNE` (this is an experimental feature for now).

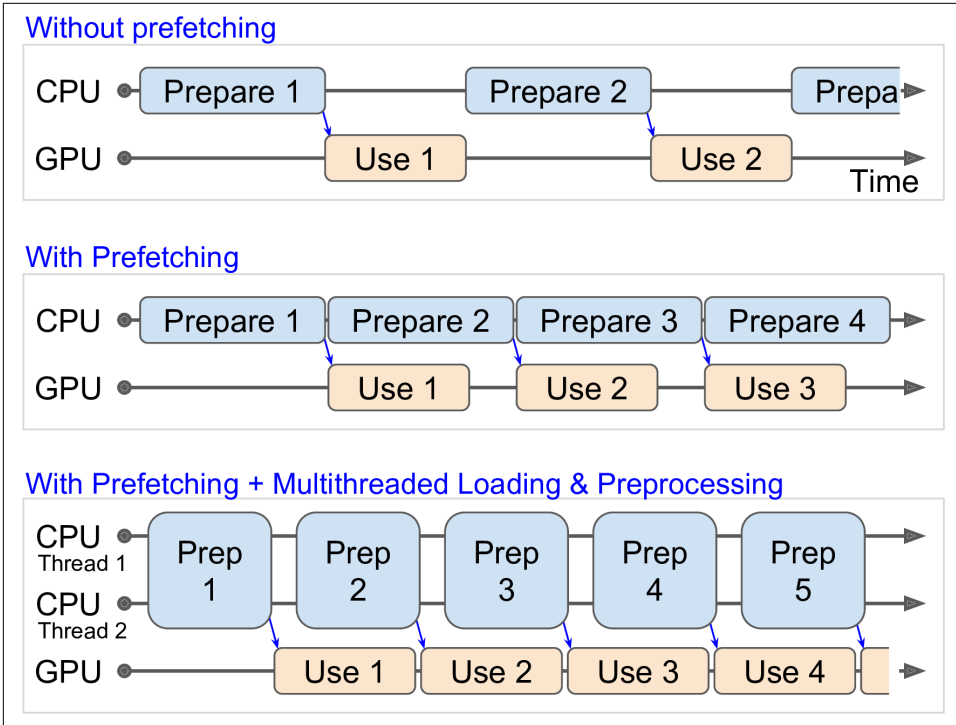

Figure 13-3. Speedup Training Thanks to Prefetching and Multithreading



If you plan to purchase a GPU card, its processing power and its memory size are of course very important (in particular, a large RAM is crucial for computer vision), but its *memory bandwidth* is just as important as the processing power to get good performance: this is the number of gigabytes of data it can get in or out of its RAM per second.

With that, you can now build efficient input pipelines to load and preprocess data from multiple text files. We have discussed the most common dataset methods, but there are a few more you may want to look at: `concatenate()`, `zip()`, `window()`, `reduce()`, `cache()`, `shard()`, `flat_map()` and `padded_batch()`. There are also a couple more class methods: `from_generator()` and `from_tensors()`, which create a new dataset from a Python generator or a list of tensors respectively. Please check the API documentation for more details. Also note that there are experimental features available in `tf.data.experimental`, many of which will most likely make it to the core API in future releases (e.g., check out the `CsvDataset` class and the `SqlDataset` classes).

Using the Dataset With `tf.keras`

Now we can use the `csv_reader_dataset()` function to create a dataset for the training set (ensuring it repeats the data forever), the validation set and the test set:

```
train_set = csv_reader_dataset(train_filepaths, repeat=None)
valid_set = csv_reader_dataset(valid_filepaths)
test_set = csv_reader_dataset(test_filepaths)
```

And now we can simply build and train a Keras model using these datasets.³ All we need to do is to call the `fit()` method with the datasets instead of `X_train` and `y_train`, and specify the number of steps per epoch for each set:⁴

```
model = keras.models.Sequential([...])
model.compile([...])
model.fit(train_set, steps_per_epoch=len(X_train) // batch_size, epochs=10,
          validation_data=valid_set,
          validation_steps=len(X_valid) // batch_size)
```

Similarly, we can pass a dataset to the `evaluate()` and `predict()` methods (and again specify the number of steps per epoch):

```
model.evaluate(test_set, steps=len(X_test) // batch_size)
model.predict(new_set, steps=len(X_new) // batch_size)
```

Unlike the other sets, the `new_set` will usually not contain labels (if it does, Keras will just ignore them). Note that in all these cases, you can still use NumPy arrays instead of datasets if you want (but of course they need to have been loaded and preprocessed first).

If you want to build your own custom training loop (as in [Chapter 12](#)), you can just iterate over the training set, very naturally:

```
for X_batch, y_batch in train_set:
    [...] # perform one gradient descent step
```

In fact, it is even possible to create a `tf.function` (see [Chapter 12](#)) that performs the whole training loop!⁵

```
@tf.function
def train(model, optimizer, loss_fn, n_epochs, [...]):
    train_set = csv_reader_dataset(train_filepaths, repeat=n_epochs, [...])
    for X_batch, y_batch in train_set:
        with tf.GradientTape() as tape:
```

3 Support for datasets is specific to `tf.keras`, it will not work on other implementations of the Keras API.

4 The number of steps per epoch is optional if the dataset just goes through the data once, but if you do not specify it, the progress bar will not be displayed during the first epoch.

5 Note that for now the dataset must be created within the TF Function. This may be fixed by the time you read these lines (see TensorFlow issue #25414).

```

y_pred = model(X_batch)
main_loss = tf.reduce_mean(loss_fn(y_batch, y_pred))
loss = tf.add_n([main_loss] + model.losses)
grads = tape.gradient(loss, model.trainable_variables)
optimizer.apply_gradients(zip(grads, model.trainable_variables))

```

Congratulations, you now know how to build powerful input pipelines using the Data API! However, so far we have used CSV files, which are common, simple and convenient, but they are not really efficient, and they do not support large or complex data structures very well, such as images or audio. So let's use TFRecords instead.



If you are happy with CSV files (or whatever other format you are using), you do not *have* to use TFRecords. As the saying goes, if it ain't broke, don't fix it! TFRecords are useful when the bottleneck during training is loading and parsing the data.

The TFRecord Format

The TFRecord format is TensorFlow's preferred format for storing large amounts of data and reading it efficiently. It is a very simple binary format that just contains a sequence of binary records of varying sizes (each record just has a length, a CRC checksum to check that the length was not corrupted, then the actual data, and finally a CRC checksum for the data). You can easily create a TFRecord file using the `tf.io.TFRecordWriter` class:

```

with tf.io.TFRecordWriter("my_data.tfrecord") as f:
    f.write(b"This is the first record")
    f.write(b"And this is the second record")

```

And you can then use a `tf.data.TFRecordDataset` to read one or more TFRecord files:

```

filepaths = ["my_data.tfrecord"]
dataset = tf.data.TFRecordDataset(filepaths)
for item in dataset:
    print(item)

```

This will output:

```

tf.Tensor(b'This is the first record', shape=(), dtype=string)
tf.Tensor(b'And this is the second record', shape=(), dtype=string)

```



By default, a `TFRecordDataset` will read files one by one, but you can make it read multiple files in parallel and interleave their records by setting `num_parallel_reads`. Alternatively, you could obtain the same result by using `list_files()` and `interleave()` as we did earlier to read multiple CSV files.

Compressed TFRecord Files

It can sometimes be useful to compress your TFRecord files, especially if they need to be loaded via a network connection. You can create a compressed TFRecord file by setting the options argument:

```
options = tf.io.TFRecordOptions(compression_type="GZIP")
with tf.io.TFRecordWriter("my_compressed.tfrecord", options) as f:
    [...]
```

When reading a compressed TFRecord file, you need to specify the compression type:

```
dataset = tf.data.TFRecordDataset(["my_compressed.tfrecord"],
                                   compression_type="GZIP")
```

A Brief Introduction to Protocol Buffers

Even though each record can use any binary format you want, TFRecord files usually contain serialized Protocol Buffers (also called *protobufs*). This is a portable, extensible and efficient binary format developed at Google back in 2001 and Open Sourced in 2008, and they are now widely used, in particular in [gRPC](#), Google's remote procedure call system. Protocol Buffers are defined using a simple language that looks like this:

```
syntax = "proto3";
message Person {
    string name = 1;
    int32 id = 2;
    repeated string email = 3;
}
```

This definition says we are using the protobuf format version 3, and it specifies that each Person object⁶ may (optionally) have a name of type `string`, an `id` of type `int32`, and zero or more `email` fields, each of type `string`. The numbers 1, 2 and 3 are the field identifiers: they will be used in each record's binary representation. Once you have a definition in a `.proto` file, you can compile it. This requires `protoc`, the protobuf compiler, to generate access classes in Python (or some other language). Note that the protobuf definitions we will use have already been compiled for you, and their Python classes are part of TensorFlow, so you will not need to use `protoc`. All you need to know is how to use protobuf access classes in Python. To illustrate the basics, let's look at a simple example that uses the access classes generated for the Person protobuf (the code is explained in the comments):

```
>>> from person_pb2 import Person # import the generated access class
>>> person = Person(name="Al", id=123, email=["a@b.com"]) # create a Person
>>> print(person) # display the Person
```

⁶ Since protobuf objects are meant to be serialized and transmitted, they are called *messages*.

```

name: "Al"
id: 123
email: "a@b.com"
>>> person.name # read a field
"Al"
>>> person.name = "Alice" # modify a field
>>> person.email[0] # repeated fields can be accessed like arrays
"a@b.com"
>>> person.email.append("c@d.com") # add an email address
>>> s = person.SerializeToString() # serialize the object to a byte string
>>> s
b'\n\x05Alice\x10{\x1a\x07a@b.com\x1a\x07c@d.com'
>>> person2 = Person() # create a new Person
>>> person2.ParseFromString(s) # parse the byte string (27 bytes long)
27
>>> person == person2 # now they are equal
True

```

In short, we import the `Person` class generated by `protoc`, we create an instance and we play with it, visualizing it, reading and writing some fields, then we serialize it using the `SerializeToString()` method. This is the binary data that is ready to be saved or transmitted over the network. When reading or receiving this binary data, we can parse it using the `ParseFromString()` method, and we get a copy of the object that was serialized.⁷

We could save the serialized `Person` object to a `TFRecord` file, then we could load and parse it: everything would work fine. However, `SerializeToString()` and `ParseFromString()` are not TensorFlow operations (and neither are the other operations in this code), so they cannot be included in a TensorFlow Function (except by wrapping them in a `tf.py_function()` operation, which would make the code slower and less portable, as we saw in [Chapter 12](#)). Fortunately, TensorFlow does include special protobuf definitions for which it provides parsing operations.

TensorFlow Protobufs

The main protobuf typically used in a `TFRecord` file is the `Example` protobuf, which represents one instance in a dataset. It contains a list of named features, where each feature can either be a list of byte strings, a list of floats or a list of integers. Here is the protobuf definition:

```

syntax = "proto3";
message BytesList { repeated bytes value = 1; }
message FloatList { repeated float value = 1 [packed = true]; }
message Int64List { repeated int64 value = 1 [packed = true]; }

```

⁷ This chapter contains the bare minimum you need to know about protobufs to use `TFRecords`. To learn more about protobufs, please visit <https://homl.info/protobuf>.

```

message Feature {
  oneof kind {
    BytesList bytes_list = 1;
    FloatList float_list = 2;
    Int64List int64_list = 3;
  }
};
message Features { map<string, Feature> feature = 1; };
message Example { Features features = 1; };

```

The definitions of `BytesList`, `FloatList` and `Int64List` are straightforward enough (`[packed = true]` is used for repeated numerical fields, for a more efficient encoding). A `Feature` either contains a `BytesList`, a `FloatList` or an `Int64List`. A `Features` (with an `s`) contains a dictionary that maps a feature name to the corresponding feature value. And finally, an `Example` just contains a `Features` object.⁸ Here is how you could create a `tf.train.Example` representing the same person as earlier, and write it to TFRecord file:

```

from tensorflow.train import BytesList, FloatList, Int64List
from tensorflow.train import Feature, Features, Example

person_example = Example(
    features=Features(
        feature={
            "name": Feature(bytes_list=BytesList(value=[b"Alice"])),
            "id": Feature(int64_list=Int64List(value=[123])),
            "emails": Feature(bytes_list=BytesList(value=[b"a@b.com",
                b"c@d.com"]))
        })
)

```

The code is a bit verbose and repetitive, but it's rather straightforward (and you could easily wrap it inside a small helper function). Now that we have an `Example` protobuf, we can serialize it by calling its `SerializeToString()` method, then write the resulting data to a TFRecord file:

```

with tf.io.TFRecordWriter("my_contacts.tfrecord") as f:
    f.write(person_example.SerializeToString())

```

Normally you would write much more than just one example! Typically, you would create a conversion script that reads from your current format (say, CSV files), creates an `Example` protobuf for each instance, serializes them and saves them to several TFRecord files, ideally shuffling them in the process. This requires a bit of work, so once again make sure it is really necessary (perhaps your pipeline works fine with CSV files).

⁸ Why was `Example` even defined since it contains no more than a `Features` object? Well, TensorFlow may one day decide to add more fields to it. As long as the new `Example` definition still contains the `features` field, with the same id, it will be backward compatible. This extensibility is one of the great features of protobufs.

Now that we have a nice TFRecord file containing a serialized Example, let's try to load it.

Loading and Parsing Examples

To load the serialized Example protobufs, we will use a `tf.data.TFRecordDataset` once again, and we will parse each Example using `tf.io.parse_single_example()`. This is a TensorFlow operation so it can be included in a TF Function. It requires at least two arguments: a string scalar tensor containing the serialized data, and a description of each feature. The description is a dictionary that maps each feature name to either a `tf.io.FixedLenFeature` descriptor indicating the feature's shape, type and default value, or a `tf.io.VarLenFeature` descriptor indicating only the type (if the length may vary, such as for the "emails" feature). For example:

```
feature_description = {
    "name": tf.io.FixedLenFeature([], tf.string, default_value=""),
    "id": tf.io.FixedLenFeature([], tf.int64, default_value=0),
    "emails": tf.io.VarLenFeature(tf.string),
}

for serialized_example in tf.data.TFRecordDataset(["my_contacts.tfrecord"]):
    parsed_example = tf.io.parse_single_example(serialized_example,
                                               feature_description)
```

The fixed length features are parsed as regular tensors, but the variable length features are parsed as sparse tensors. You can convert a sparse tensor to a dense tensor using `tf.sparse.to_dense()`, but in this case it is simpler to just access its values:

```
>>> tf.sparse.to_dense(parsed_example["emails"], default_value=b"")
<tf.Tensor: [...] dtype=string, numpy=array([b'a@b.com', b'c@d.com'], [...])>
>>> parsed_example["emails"].values
<tf.Tensor: [...] dtype=string, numpy=array([b'a@b.com', b'c@d.com'], [...])>
```

A `BytesList` can contain any binary data you want, including any serialized object. For example, you can use `tf.io.encode_jpeg()` to encode an image using the JPEG format, and put this binary data in a `BytesList`. Later, when your code reads the TFRecord, it will start by parsing the Example, then you will need to call `tf.io.decode_jpeg()` to parse the data and get the original image (or you can use `tf.io.decode_image()`, which can decode any BMP, GIF, JPEG or PNG image). You can also store any tensor you want in a `BytesList` by serializing the tensor using `tf.io.serialize_tensor()`, then putting the resulting byte string in a `BytesList` feature. Later, when you parse the TFRecord, you can parse this data using `tf.io.parse_tensor()`.

Instead of parsing examples one by one using `tf.io.parse_single_example()`, you may want to parse them batch by batch using `tf.io.parse_example()`:

```
dataset = tf.data.TFRecordDataset(["my_contacts.tfrecord"]).batch(10)
for serialized_examples in dataset:
    parsed_examples = tf.io.parse_example(serialized_examples,
                                          feature_description)
```

As you can see, the `Example` proto will probably be sufficient for most use cases. However, it may be a bit cumbersome to use when you are dealing with lists of lists. For example, suppose you want to classify text documents. Each document may be represented as a list of sentences, where each sentence is represented as a list of words. And perhaps each document also has a list of comments, where each comment is also represented as a list of words. Moreover, there may be some contextual data as well, such as the document's author, title and publication date. TensorFlow's `SequenceExample` protobuf is designed for such use cases.

Handling Lists of Lists Using the `SequenceExample` Protobuf

Here is the definition of the `SequenceExample` protobuf:

```
message FeatureList { repeated Feature feature = 1; };
message FeatureLists { map<string, FeatureList> feature_list = 1; };
message SequenceExample {
    Features context = 1;
    FeatureLists feature_lists = 2;
};
```

A `SequenceExample` contains a `Features` object for the contextual data and a `FeatureLists` object which contains one or more named `FeatureList` objects (e.g., a `FeatureList` named "content" and another named "comments"). Each `FeatureList` just contains a list of `Feature` objects, each of which may be a list of byte strings, a list of 64-bit integers or a list of floats (in this example, each `Feature` would represent a sentence or a comment, perhaps in the form of a list of word identifiers). Building a `SequenceExample`, serializing it and parsing it is very similar to building, serializing and parsing an `Example`, but you must use `tf.io.parse_single_sequence_example()` to parse a single `SequenceExample` or `tf.io.parse_sequence_example()` to parse a batch, and both functions return a tuple containing the context features (as a dictionary) and the feature lists (also as a dictionary). If the feature lists contain sequences of varying sizes (as in the example above), you may want to convert them to ragged tensors using `tf.RaggedTensor.from_sparse()` (see the notebook for the full code):

```
parsed_context, parsed_feature_lists = tf.io.parse_single_sequence_example(
    serialized_sequence_example, context_feature_descriptions,
    sequence_feature_descriptions)
parsed_content = tf.RaggedTensor.from_sparse(parsed_feature_lists["content"])
```

Now that you know how to efficiently store, load and parse data, the next step is to prepare it so that it can be fed to a neural network. This means converting all features

into numerical features (ideally not too sparse), scaling them, and more. In particular, if your data contains categorical features or text features, they need to be converted to numbers. For this, the *Features API* can help.

The Features API

Preprocessing your data can be performed in many ways: it can be done ahead of time when preparing your data files, using any tool you like. Or you can preprocess your data on the fly when loading it with the Data API (e.g., using the dataset's `map()` method, as we saw earlier). Or you can include a preprocessing layer directly in your model. Whichever solution you prefer, the Features API can help you: it is a set of functions available in the `tf.feature_column` package, which let you define how each feature (or group of features) in your data should be preprocessed (therefore you can think of this API as the analog of Scikit-Learn's `ColumnTransformer` class). We will start by looking at the different types of columns available, and then we will look at how to use them.

Let's go back to the variant of the California housing dataset that we used in [Chapter 2](#), since it includes a categorical feature and missing data. Here is a simple numerical column named "housing_median_age":

```
housing_median_age = tf.feature_column.numeric_column("housing_median_age")
```

Numeric columns let you specify a normalization function using the `normalizer_fn` argument. For example, let's tweak the "housing_median_age" column to define how it should be scaled. Note that this requires computing ahead of time the mean and standard deviation of this feature in the training set:

```
age_mean, age_std = X_mean[1], X_std[1] # The median age is column in 1
housing_median_age = tf.feature_column.numeric_column(
    "housing_median_age", normalizer_fn=lambda x: (x - age_mean) / age_std)
```

In some cases, it might improve performance to bucketize some numerical features, effectively transforming a numerical feature into a categorical feature. For example, let's create a bucketized column based on the `median_income` column, with 5 buckets: less than 1.5 (\$15,000), then 1.5 to 3, 3 to 4.5, 4.5 to 6., and above 6. (notice that when you specify 4 boundaries, there are actually 5 buckets):

```
median_income = tf.feature_column.numeric_column("median_income")
bucketized_income = tf.feature_column.bucketized_column(
    median_income, boundaries=[1.5, 3., 4.5, 6.]
```

If the `median_income` feature is equal to, say, 3.2, then the `bucketized_income` feature will automatically be equal to 2 (i.e., the index of the corresponding income bucket). Choosing the right boundaries can be somewhat of an art, but one approach is to just use percentiles of the data (e.g., the 10th percentile, the 20th percentile, and so on). If a feature is *multimodal*, meaning it has separate peaks in its distribution, you may

want to define a bucket for each mode, placing the boundaries in between the peaks. Whether you use the percentiles or the modes, you need to analyze the distribution of your data ahead of time, just like we had to measure the mean and standard deviation ahead of time to normalize the `housing_median_age` column.

Categorical Features

For categorical features such as `ocean_proximity`, there are several options. If it is already represented as a category ID (i.e., an integer from 0 to the max ID), then you can use the `categorical_column_with_identity()` function (specifying the max ID). If not, and you know the list of all possible categories, then you can use `categorical_column_with_vocabulary_list()`:

```
ocean_prox_vocab = ['<1H OCEAN', 'INLAND', 'ISLAND', 'NEAR BAY', 'NEAR OCEAN']
ocean_proximity = tf.feature_column.categorical_column_with_vocabulary_list(
    "ocean_proximity", ocean_prox_vocab)
```

If you prefer to have TensorFlow load the vocabulary from a file, you can call `categorical_column_with_vocabulary_file()` instead. As you might expect, these two functions will simply map each category to its index in the vocabulary (e.g., `NEAR BAY` will be mapped to 3), and unknown categories will be mapped to -1.

For categorical columns with a large vocabulary (e.g., for zipcodes, cities, words, products, users, etc.), it may not be convenient to get the full list of possible categories, or perhaps categories may be added or removed so frequently that using category indices would be too unreliable. In this case, you may prefer to use a `categorical_column_with_hash_bucket()`. If we had a "city" feature in the dataset, we could encode it like this:

```
city_hash = tf.feature_column.categorical_column_with_hash_bucket(
    "city", hash_bucket_size=1000)
```

This feature will compute a hash for each category (i.e., for each city), modulo the number of hash buckets (`hash_bucket_size`). You must set the number of buckets high enough to avoid getting too many collisions (i.e., different categories ending up in the same bucket), but the higher you set it, the more RAM will be used (by the embedding table, as we will see shortly).

Crossed Categorical Features

If you suspect that two (or more) categorical features are more meaningful when used jointly, then you can create a *crossed column*. For example, suppose people are particularly fond of old houses inland and new houses near the ocean, then it might help to

create a bucketized column for the `housing_median_age` feature⁹, and cross it with the `ocean_proximity` column. The crossed column will compute a hash of every age & ocean proximity combination it comes across, modulo the `hash_bucket_size`, and this will give it the cross category ID. You may then choose to use only this crossed column in your model, or also include the individual columns.

```
bucketized_age = tf.feature_column.bucketized_column(
    housing_median_age, boundaries=[-1., -0.5, 0., 0.5, 1.]) # age was scaled
age_and_ocean_proximity = tf.feature_column.crossed_column(
    [bucketized_age, ocean_proximity], hash_bucket_size=100)
```

Another common use case for crossed columns is to cross latitude and longitude into a single categorical feature: you start by bucketizing the latitude and longitude, for example into 20 buckets each, then you cross these bucketized features into a location column. This will create a 20×20 grid over California, and each cell in the grid will correspond to one category:

```
latitude = tf.feature_column.numeric_column("latitude")
longitude = tf.feature_column.numeric_column("longitude")
bucketized_latitude = tf.feature_column.bucketized_column(
    latitude, boundaries=list(np.linspace(32., 42., 20 - 1)))
bucketized_longitude = tf.feature_column.bucketized_column(
    longitude, boundaries=list(np.linspace(-125., -114., 20 - 1)))
location = tf.feature_column.crossed_column(
    [bucketized_latitude, bucketized_longitude], hash_bucket_size=1000)
```

Encoding Categorical Features Using One-Hot Vectors

No matter which option you choose to build a categorical feature (categorical columns, bucketized columns or crossed columns), it must be encoded before you can feed it to a neural network. There are two options to encode a categorical feature: one-hot vectors or *embeddings*. For the first option, simply use the `indicator_column()` function:

```
ocean_proximity_one_hot = tf.feature_column.indicator_column(ocean_proximity)
```

A one-hot vector encoding has the size of the vocabulary length, which is fine if there are just a few possible categories, but if the vocabulary is large, you will end up with too many inputs fed to your neural network: it will have too many weights to learn and it will probably not perform very well. In particular, this will typically be the case when you use hash buckets. In this case, you should probably encode them using *embeddings* instead.

⁹ Since the `housing_median_age` feature was normalized, the boundaries are for normalized ages.



As a rule of thumb (but your mileage may vary!), if the number of categories is lower than 10, then one-hot encoding is generally the way to go. If the number of categories is greater than 50 (which is often the case when you use hash buckets), then embeddings are usually preferable. In between 10 and 50 categories, you may want to experiment with both options and see which one works best for your use case. Also, embeddings typically require more training data, unless you can reuse pretrained embeddings.

Encoding Categorical Features Using Embeddings

An embedding is a trainable dense vector that represents a category. By default, embeddings are initialized randomly, so for example the "NEAR BAY" category could be represented initially by a random vector such as $[0.131, 0.890]$, while the "NEAR OCEAN" category may be represented by another random vector such as $[0.631, 0.791]$ (in this example, we are using 2D embeddings, but the number of dimensions is a hyperparameter you can tweak). Since these embeddings are trainable, they will gradually improve during training, and as they represent fairly similar categories, Gradient Descent will certainly end up pushing them closer together, while it will tend to move them away from the "INLAND" category's embedding (see [Figure 13-4](#)). Indeed, the better the representation, the easier it will be for the neural network to make accurate predictions, so training tends to make embeddings useful representations of the categories. This is called *representation learning* (we will see other types of representation learning in [???](#)).

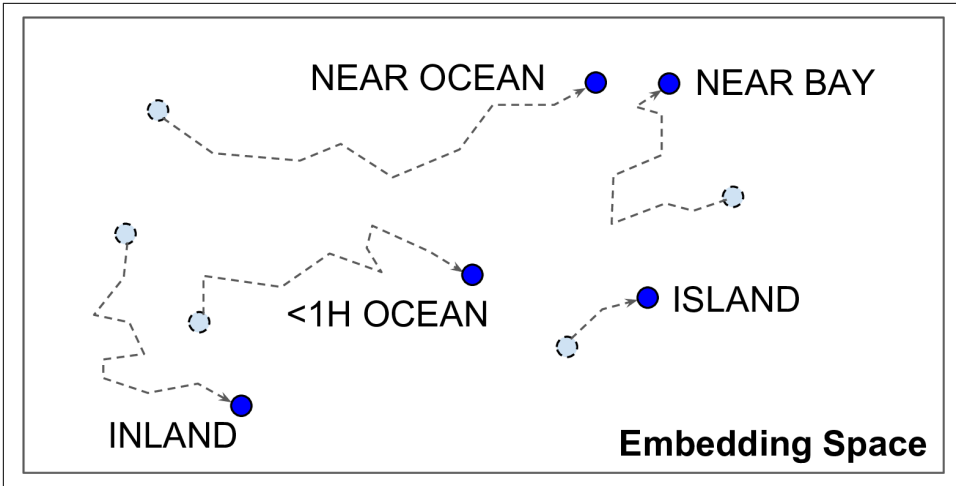

Figure 13-4. Embeddings Will Gradually Improve During Training

Word Embeddings

Not only will embeddings generally be useful representations for the task at hand, but quite often these same embeddings can be reused successfully for other tasks as well. The most common example of this is *word embeddings* (i.e., embeddings of individual words): when you are working on a natural language processing task, you are often better off reusing pretrained word embeddings than training your own. The idea of using vectors to represent words dates back to the 1960s, and many sophisticated techniques have been used to generate useful vectors, including using neural networks, but things really took off in 2013, when Tomáš Mikolov and other Google researchers published a [paper](#)¹⁰ describing how to learn word embeddings using deep neural networks, much faster than previous attempts. This allowed them to learn embeddings on a very large corpus of text: they trained a deep neural network to predict the words near any given word. This allowed them to obtain astounding word embeddings. For example, synonyms had very close embeddings, and semantically related words such as France, Spain, Italy, and so on, ended up clustered together. But it's not just about proximity: word embeddings were also organized along meaningful axes in the embedding space. Here is a famous example: if you compute King - Man + Woman (adding and subtracting the embedding vectors of these words), then the result will be very close to the embedding of the word Queen (see [Figure 13-5](#)). In other words, the word embeddings encode the concept of gender! Similarly, you can compute Madrid - Spain + France, and of course the result is close to Paris, which seems to show that the notion of capital city was also encoded in the embeddings.

¹⁰ "Distributed Representations of Words and Phrases and their Compositionality", T. Mikolov et al. (2013).

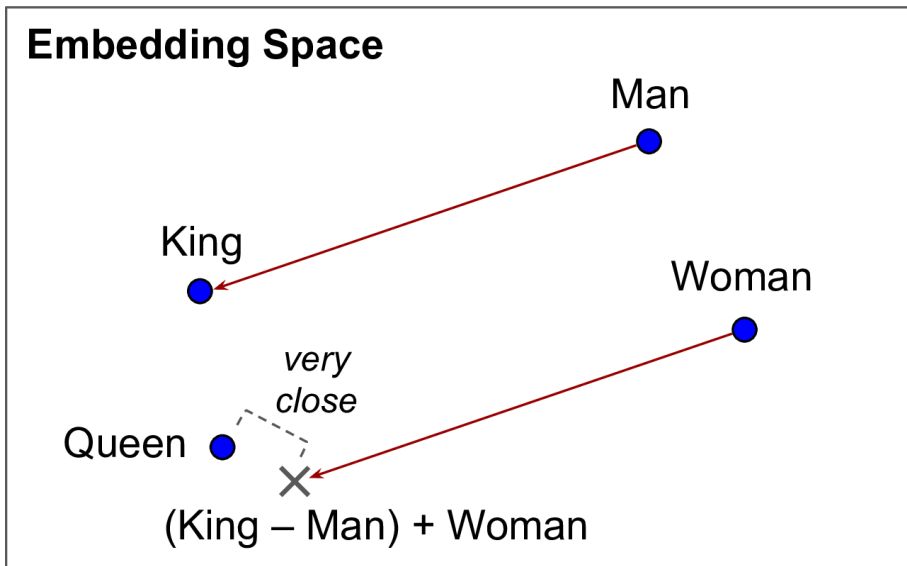

Figure 13-5. Word Embeddings

Let's go back to the Features API. Here is how you could encode the `ocean_proximity` categories as 2D embeddings:

```
ocean_proximity_embed = tf.feature_column.embedding_column(ocean_proximity,
                                                         dimension=2)
```

Each of the five `ocean_proximity` categories will now be represented as a 2D vector. These vectors are stored in an *embedding matrix* with one row per category, and one column per embedding dimension, so in this example it is a 5×2 matrix. When an embedding column is given a category index as input (say, 3, which corresponds to the category "NEAR BAY"), it just performs a lookup in the embedding matrix and returns the corresponding row (say, $[0.331, 0.190]$). Unfortunately, the embedding matrix can be quite large, especially when you have a large vocabulary: if this is the case, the model can only learn good representations for the categories for which it has sufficient training data. To reduce the size of the embedding matrix, you can of course try lowering the `dimension` hyperparameter, but if you reduce this parameter too much, the representations may not be as good. Another option is to reduce the vocabulary size (e.g., if you are dealing with text, you can try dropping the rare words from the vocabulary, and replace them all with a token like "<unknown>" or "<UNK>"). If you are using hash buckets, you can also try reducing the `hash_bucket_size` (but not too much, or else you will get collisions).



If there are no pretrained embeddings that you can reuse for the task you are trying to tackle, and if you do not have enough training data to learn them, then you can try to learn them on some auxiliary task for which it is easier to obtain plenty of training data. After that, you can reuse the trained embeddings for your main task.

Using Feature Columns for Parsing

Let's suppose you have created feature columns for each of your input features, as well as for the target. What can you do with them? Well, for one you can pass them to the `make_parse_example_spec()` function to generate feature descriptions (so you don't have to do it manually, as we did earlier):

```
columns = [bucketized_age, ..., median_house_value] # all features + target
feature_descriptions = tf.feature_column.make_parse_example_spec(columns)
```



You don't always have to create a separate feature column for each and every feature. For example, instead of having 2 numerical feature columns, you could choose to have a single 2D column: just set `shape=[2]` when calling `numerical_column()`.

You can then create a function that parses serialized examples using these feature descriptions, and separates the target column from the input features:

```
def parse_examples(serialized_examples):
    examples = tf.io.parse_example(serialized_examples, feature_descriptions)
    targets = examples.pop("median_house_value") # separate the targets
    return examples, targets
```

Next, you can create a `TFRecordDataset` that will read batches of serialized examples (assuming the `TFRecord` file contains serialized `Example` protobufs with the appropriate features):

```
batch_size = 32
dataset = tf.data.TFRecordDataset(["my_data_with_features.tfrecords"])
dataset = dataset.repeat().shuffle(10000).batch(batch_size).map(parse_examples)
```

Using Feature Columns in Your Models

Feature columns can also be used directly in your model, to convert all your input features into a single dense vector which the neural network can then process. For this, all you need to do is add a `keras.layers.DenseFeatures` layer as the first layer in your model, passing it the list of feature columns (excluding the target column):

```
columns_without_target = columns[:-1]
model = keras.models.Sequential([
    keras.layers.DenseFeatures(feature_columns=columns_without_target),
```

```

keras.layers.Dense(1)
])
model.compile(loss="mse", optimizer="sgd", metrics=["accuracy"])
steps_per_epoch = len(X_train) // batch_size
history = model.fit(dataset, steps_per_epoch=steps_per_epoch, epochs=5)

```

The DenseFeatures layer will take care of converting every input feature to a dense representation, and it will also apply any extra transformation we specified, such as scaling the housing_median_age using the normalizer_fn function we provided. You can take a closer look at what the DenseFeatures layer does by calling it directly:

```

>>> some_columns = [ocean_proximity_embed, bucketized_income]
>>> dense_features = keras.layers.DenseFeatures(some_columns)
>>> dense_features({
...     "ocean_proximity": [{"NEAR OCEAN"}, {"INLAND"}, {"INLAND"}],
...     "median_income": [[3.], [7.2], [1.]]
... })
...
<tf.Tensor: id=559790, shape=(3, 7), dtype=float32, numpy=
array([[ 0. ,  0. ,  1. ,  0. ,  0. , -0.36277947 ,  0.30109018],
       [ 0. ,  0. ,  0. ,  0. ,  1. ,  0.22548223 ,  0.33142096],
       [ 1. ,  0. ,  0. ,  0. ,  0. ,  0.22548223 ,  0.33142096]], dtype=float32)>

```

In this example, we create a DenseFeatures layer with just two columns, and we call it with some data, in the form of a dictionary of features. In this case, since the bucketized_income column relies on the median_income column, the dictionary must include the "median_income" key, and similarly since the ocean_proximity_embed column is based on the ocean_proximity column, the dictionary must include the "ocean_proximity" key. Columns are handled in alphabetical order, so first we look at the bucketized income column (its name is the same as the median_income column name, plus "_bucketized"). The incomes 3, 7.2 and 1 get mapped respectively to category 2 (for incomes between 1.5 and 3), category 0 (for incomes below 1.5), and category 4 (for incomes greater than 6). Then these category IDs get one-hot encoded: category 2 gets encoded as [0., 0., 1., 0., 0.] and so on (note that bucketized columns get one-hot encoded by default, no need to call indicator_column()). Now on to the ocean_proximity_embed column. The "NEAR OCEAN" and "INLAND" categories just get mapped to their respective embeddings (which were initialized randomly). The resulting tensor is the concatenation of the one-hot vectors and the embeddings.

Now you can feed all kinds of features to a neural network, including numerical features, categorical features, and even text (by splitting the text into words, then using word embedding)! However, performing all the preprocessing on the fly can slow down training. Let's see how this can be improved.

TF Transform

If preprocessing is computationally expensive, then handling it before training rather than on the fly may give you a significant speedup: the data will be preprocessed just once per instance *before* training, rather than once per instance and per epoch *during* training. Tools like Apache Beam let you run efficient data processing pipelines over large amounts of data, even distributed across multiple servers, so why not use it to preprocess all the training data? This works great and indeed can speed up training, but there is one problem: once your model is trained, suppose you want to deploy it to a mobile app: you will need to write some code in your app to take care of preprocessing the data before it is fed to the model. And suppose you also want to deploy the model to TensorFlow.js so it runs in a web browser? Once again, you will need to write some preprocessing code. This can become a maintenance nightmare: whenever you want to change the preprocessing logic, you will need to update your Apache Beam code, your mobile app code and your Javascript code. It is not only time consuming, but also error prone: you may end up with subtle differences between the preprocessing operations performed before training and the ones performed in your app or in the browser. This *training/serving skew* will lead to bugs or degraded performance.

One improvement would be to take the trained model (trained on data that was preprocessed by your Apache Beam code), and before deploying it to your app or the browser, add an extra input layer to take care of preprocessing on the fly (either by writing a custom layer or by using a `DenseFeatures` layer). That's definitely better, since now you just have two versions of your preprocessing code: the Apache Beam code and the preprocessing layer's code.

But what if you could define your preprocessing operations just once? This is what TF Transform was designed for. It is part of **TensorFlow Extended** (TFX), an end-to-end platform for productionizing TensorFlow models. First, to use a TFX component, such as TF Transform, you must install it, it does not come bundled with TensorFlow. You define your preprocessing function just once (in Python), by using TF Transform functions for scaling, bucketizing, crossing features, and more. You can also use any TensorFlow operation you need. Here is what this preprocessing function might look like if we just had two features:

```
import tensorflow_transform as tft

def preprocess(inputs): # inputs is a batch of input features
    median_age = inputs["housing_median_age"]
    ocean_proximity = inputs["ocean_proximity"]
    standardized_age = tft.scale_to_z_score(median_age - tft.mean(median_age))
    ocean_proximity_id = tft.compute_and_apply_vocabulary(ocean_proximity)
    return {
        "standardized_median_age": standardized_age,
```

```
    "ocean_proximity_id": ocean_proximity_id
}
```

Next, TF Transform lets you apply this `preprocess()` function to the whole training set using Apache Beam (it provides an `AnalyzeAndTransformDataset` class that you can use for this purpose in your Apache Beam pipeline). In the process, it will also compute all the necessary statistics over the whole training set: in this example, the mean and standard deviation of the `housing_median_age` feature, and the vocabulary for the `ocean_proximity` feature. The components that compute these statistics are called *analyzers*.

Importantly, TF Transform will also generate an equivalent TensorFlow Function that you can plug into the model you deploy. This TF Function contains all the necessary statistics computed by Apache Beam (the mean, standard deviation, and vocabulary), simply included as constants.



At the time of this writing, TF Transform only supports TensorFlow 1. Moreover, Apache Beam only has partial support for Python 3. That said, both these limitations will likely be fixed by the time you read this.

With the Data API, TFRecords, the Features API and TF Transform, you can build highly scalable input pipelines for training, and also benefit from fast and portable data preprocessing in production.

But what if you just wanted to use a standard dataset? Well in that case, things are much simpler: just use TFDS!

The TensorFlow Datasets (TFDS) Project

The **TensorFlow Datasets** project makes it trivial to download common datasets, from small ones like MNIST or Fashion MNIST, to huge datasets like ImageNet¹¹ (you will need quite a bit of disk space!). The list includes image datasets, text datasets (including translation datasets), audio and video datasets, and more. You can visit <https://homl.info/tfds> to view the full list, along with a description of each dataset.

TFDS is not bundled with TensorFlow, so you need to install the `tensorflow-datasets` library (e.g., using pip). Then all you need to do is call the `tfds.load()` function, and it will download the data you want (unless it was already downloaded earlier), and return the data as a dictionary of `Datasets` (typically one for training,

¹¹ At the time of writing, TFDS requires you to download a few files manually for ImageNet (for legal reasons), but this will hopefully get resolved soon.

and one for testing, but this depends on the dataset you choose). For example, let's download MNIST:

```
import tensorflow_datasets as tfds

dataset = tfds.load(name="mnist")
mnist_train, mnist_test = dataset["train"], dataset["test"]
```

You can then apply any transformation you want (typically repeating, batching and prefetching), and you're ready to train your model. Here is a simple example:

```
mnist_train = mnist_train.repeat(5).batch(32).prefetch(1)
for item in mnist_train:
    images = item["image"]
    labels = item["label"]
    [...]
```



In general, `load()` returns a shuffled training set, so there's no need to shuffle it some more.

Note that each item in the dataset is a dictionary containing both the features and the labels. But Keras expects each item to be a tuple containing 2 elements (again, the features and the labels). You could transform the dataset using the `map()` method, like this:

```
mnist_train = mnist_train.repeat(5).batch(32)
mnist_train = mnist_train.map(lambda items: (items["image"], items["label"]))
mnist_train = mnist_train.prefetch(1)
```

Or you can just ask the `load()` function to do this for you by setting `as_supervised=True` (obviously this works only for labeled datasets). You can also specify the batch size if you want. Then the dataset can be passed directly to your `tf.keras` model:

```
dataset = tfds.load(name="mnist", batch_size=32, as_supervised=True)
mnist_train = dataset["train"].repeat().prefetch(1)
model = keras.models.Sequential([...])
model.compile(loss="sparse_categorical_crossentropy", optimizer="sgd")
model.fit(mnist_train, steps_per_epoch=60000 // 32, epochs=5)
```

This was quite a technical chapter, and you may feel that it is a bit far from the abstract beauty of neural networks, but the fact is deep learning often involves large amounts of data, and knowing how to load, parse and preprocess it efficiently is a crucial skill to have. In the next chapter, we will look at Convolutional Neural Networks, which are among the most successful neural net architectures for image processing, and many other applications.

Deep Computer Vision Using Convolutional Neural Networks



With Early Release ebooks, you get books in their earliest form—the author’s raw and unedited content as he or she writes—so you can take advantage of these technologies long before the official release of these titles. The following will be Chapter 14 in the final release of the book.

Although IBM’s Deep Blue supercomputer beat the chess world champion Garry Kasparov back in 1996, it wasn’t until fairly recently that computers were able to reliably perform seemingly trivial tasks such as detecting a puppy in a picture or recognizing spoken words. Why are these tasks so effortless to us humans? The answer lies in the fact that perception largely takes place outside the realm of our consciousness, within specialized visual, auditory, and other sensory modules in our brains. By the time sensory information reaches our consciousness, it is already adorned with high-level features; for example, when you look at a picture of a cute puppy, you cannot choose *not* to see the puppy, or *not* to notice its cuteness. Nor can you explain *how* you recognize a cute puppy; it’s just obvious to you. Thus, we cannot trust our subjective experience: perception is not trivial at all, and to understand it we must look at how the sensory modules work.

Convolutional neural networks (CNNs) emerged from the study of the brain’s visual cortex, and they have been used in image recognition since the 1980s. In the last few years, thanks to the increase in computational power, the amount of available training data, and the tricks presented in [Chapter 11](#) for training deep nets, CNNs have managed to achieve superhuman performance on some complex visual tasks. They power image search services, self-driving cars, automatic video classification systems, and more. Moreover, CNNs are not restricted to visual perception: they are also successful

at many other tasks, such as *voice recognition* or *natural language processing* (NLP); however, we will focus on visual applications for now.

In this chapter we will present where CNNs came from, what their building blocks look like, and how to implement them using TensorFlow and Keras. Then we will discuss some of the best CNN architectures, and discuss other visual tasks, including *object detection* (classifying multiple objects in an image and placing bounding boxes around them) and *semantic segmentation* (classifying each pixel according to the class of the object it belongs to).

The Architecture of the Visual Cortex

David H. Hubel and Torsten Wiesel performed a series of experiments on cats in 1958¹ and 1959² (and a few years later on monkeys³), giving crucial insights on the structure of the visual cortex (the authors received the Nobel Prize in Physiology or Medicine in 1981 for their work). In particular, they showed that many neurons in the visual cortex have a small *local receptive field*, meaning they react only to visual stimuli located in a limited region of the visual field (see [Figure 14-1](#), in which the local receptive fields of five neurons are represented by dashed circles). The receptive fields of different neurons may overlap, and together they tile the whole visual field. Moreover, the authors showed that some neurons react only to images of horizontal lines, while others react only to lines with different orientations (two neurons may have the same receptive field but react to different line orientations). They also noticed that some neurons have larger receptive fields, and they react to more complex patterns that are combinations of the lower-level patterns. These observations led to the idea that the higher-level neurons are based on the outputs of neighboring lower-level neurons (in [Figure 14-1](#), notice that each neuron is connected only to a few neurons from the previous layer). This powerful architecture is able to detect all sorts of complex patterns in any area of the visual field.

1 “Single Unit Activity in Striate Cortex of Unrestrained Cats,” D. Hubel and T. Wiesel (1958).

2 “Receptive Fields of Single Neurones in the Cat’s Striate Cortex,” D. Hubel and T. Wiesel (1959).

3 “Receptive Fields and Functional Architecture of Monkey Striate Cortex,” D. Hubel and T. Wiesel (1968).

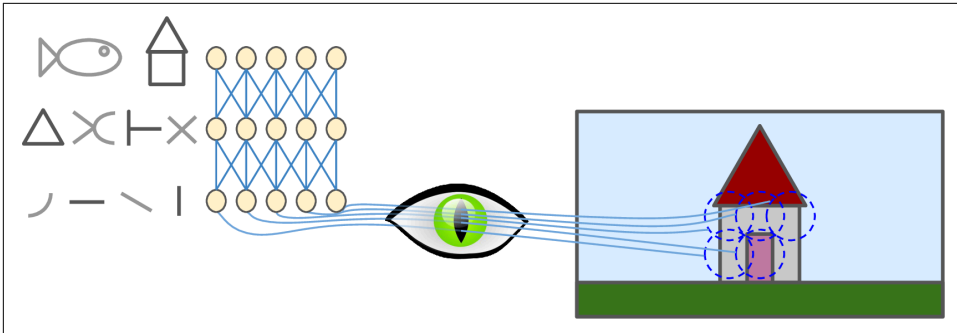

Figure 14-1. Local receptive fields in the visual cortex

These studies of the visual cortex inspired the **neocognitron**, introduced in 1980,⁴ which gradually evolved into what we now call *convolutional neural networks*. An important milestone was a **1998 paper**⁵ by Yann LeCun, Léon Bottou, Yoshua Bengio, and Patrick Haffner, which introduced the famous *LeNet-5* architecture, widely used to recognize handwritten check numbers. This architecture has some building blocks that you already know, such as fully connected layers and sigmoid activation functions, but it also introduces two new building blocks: *convolutional layers* and *pooling layers*. Let's look at them now.



Why not simply use a regular deep neural network with fully connected layers for image recognition tasks? Unfortunately, although this works fine for small images (e.g., MNIST), it breaks down for larger images because of the huge number of parameters it requires. For example, a 100×100 image has 10,000 pixels, and if the first layer has just 1,000 neurons (which already severely restricts the amount of information transmitted to the next layer), this means a total of 10 million connections. And that's just the first layer. CNNs solve this problem using partially connected layers and weight sharing.

⁴ “Neocognitron: A Self-organizing Neural Network Model for a Mechanism of Pattern Recognition Unaffected by Shift in Position,” K. Fukushima (1980).

⁵ “Gradient-Based Learning Applied to Document Recognition,” Y. LeCun et al. (1998).

Convolutional Layer

The most important building block of a CNN is the *convolutional layer*.⁶ neurons in the first convolutional layer are not connected to every single pixel in the input image (like they were in previous chapters), but only to pixels in their receptive fields (see Figure 14-2). In turn, each neuron in the second convolutional layer is connected only to neurons located within a small rectangle in the first layer. This architecture allows the network to concentrate on small low-level features in the first hidden layer, then assemble them into larger higher-level features in the next hidden layer, and so on. This hierarchical structure is common in real-world images, which is one of the reasons why CNNs work so well for image recognition.

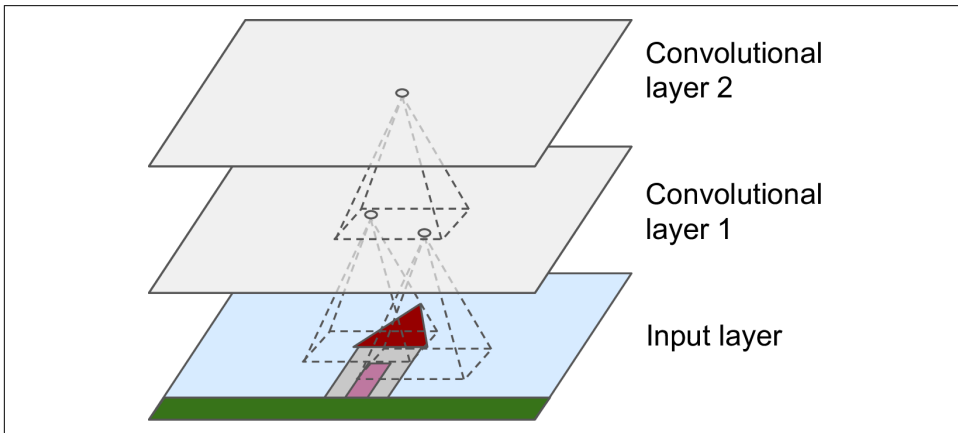

Figure 14-2. CNN layers with rectangular local receptive fields



Until now, all multilayer neural networks we looked at had layers composed of a long line of neurons, and we had to flatten input images to 1D before feeding them to the neural network. Now each layer is represented in 2D, which makes it easier to match neurons with their corresponding inputs.

A neuron located in row i , column j of a given layer is connected to the outputs of the neurons in the previous layer located in rows i to $i + f_h - 1$, columns j to $j + f_w - 1$, where f_h and f_w are the height and width of the receptive field (see Figure 14-3). In order for a layer to have the same height and width as the previous layer, it is com-

⁶ A convolution is a mathematical operation that slides one function over another and measures the integral of their pointwise multiplication. It has deep connections with the Fourier transform and the Laplace transform, and is heavily used in signal processing. Convolutional layers actually use cross-correlations, which are very similar to convolutions (see <https://homl.info/76> for more details).

mon to add zeros around the inputs, as shown in the diagram. This is called *zero padding*.

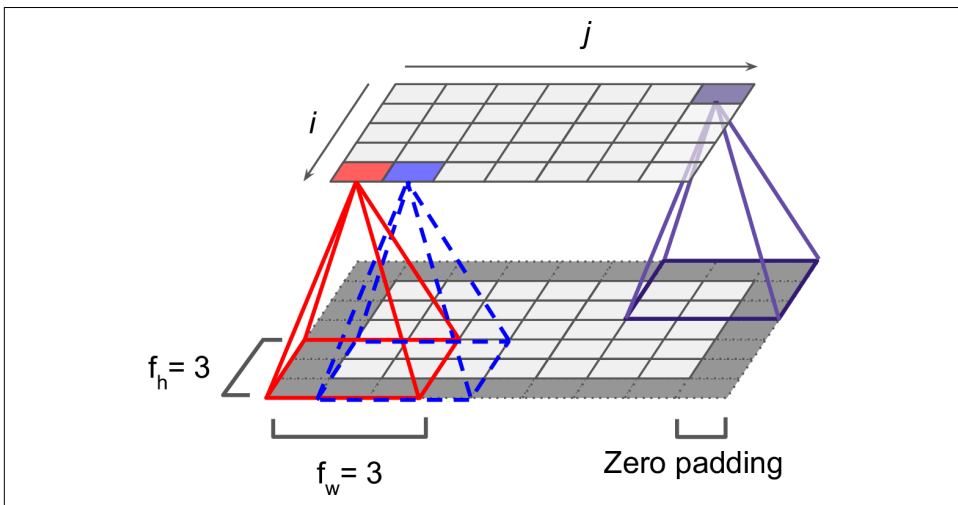

Figure 14-3. Connections between layers and zero padding

It is also possible to connect a large input layer to a much smaller layer by spacing out the receptive fields, as shown in Figure 14-4. The shift from one receptive field to the next is called the *stride*. In the diagram, a 5×7 input layer (plus zero padding) is connected to a 3×4 layer, using 3×3 receptive fields and a stride of 2 (in this example the stride is the same in both directions, but it does not have to be so). A neuron located in row i , column j in the upper layer is connected to the outputs of the neurons in the previous layer located in rows $i \times s_h$ to $i \times s_h + f_h - 1$, columns $j \times s_w$ to $j \times s_w + f_w - 1$, where s_h and s_w are the vertical and horizontal strides.

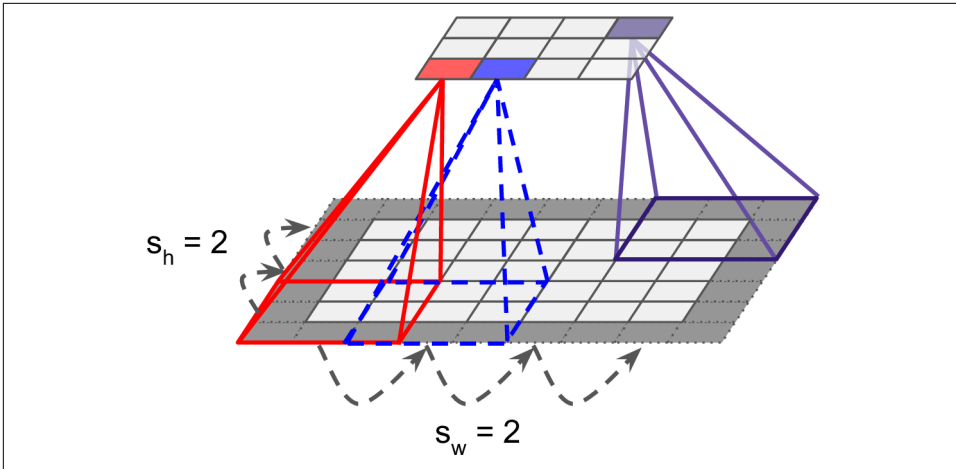

Figure 14-4. Reducing dimensionality using a stride of 2

Filters

A neuron's weights can be represented as a small image the size of the receptive field. For example, [Figure 14-5](#) shows two possible sets of weights, called *filters* (or *convolution kernels*). The first one is represented as a black square with a vertical white line in the middle (it is a 7×7 matrix full of 0s except for the central column, which is full of 1s); neurons using these weights will ignore everything in their receptive field except for the central vertical line (since all inputs will get multiplied by 0, except for the ones located in the central vertical line). The second filter is a black square with a horizontal white line in the middle. Once again, neurons using these weights will ignore everything in their receptive field except for the central horizontal line.

Now if all neurons in a layer use the same vertical line filter (and the same bias term), and you feed the network the input image shown in [Figure 14-5](#) (bottom image), the layer will output the top-left image. Notice that the vertical white lines get enhanced while the rest gets blurred. Similarly, the upper-right image is what you get if all neurons use the same horizontal line filter; notice that the horizontal white lines get enhanced while the rest is blurred out. Thus, a layer full of neurons using the same filter outputs a *feature map*, which highlights the areas in an image that activate the filter the most. Of course you do not have to define the filters manually: instead, during training the convolutional layer will automatically learn the most useful filters for its task, and the layers above will learn to combine them into more complex patterns.

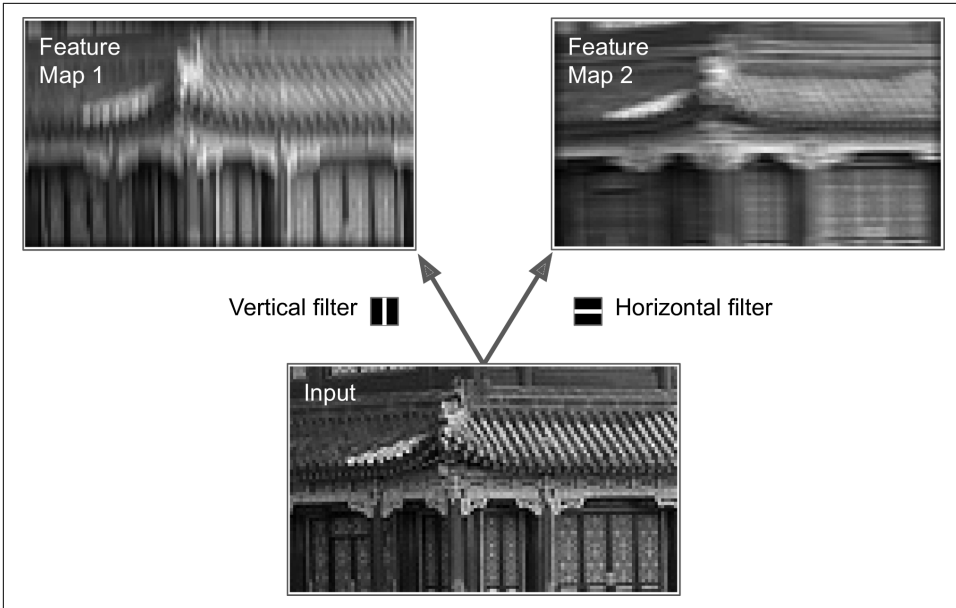

Figure 14-5. Applying two different filters to get two feature maps

Stacking Multiple Feature Maps

Up to now, for simplicity, I have represented the output of each convolutional layer as a thin 2D layer, but in reality a convolutional layer has multiple filters (you decide how many), and it outputs one feature map per filter, so it is more accurately represented in 3D (see Figure 14-6). To do so, it has one neuron per pixel in each feature map, and all neurons within a given feature map share the same parameters (i.e., the same weights and bias term). However, neurons in different feature maps use different parameters. A neuron's receptive field is the same as described earlier, but it extends across all the previous layers' feature maps. In short, a convolutional layer simultaneously applies multiple trainable filters to its inputs, making it capable of detecting multiple features anywhere in its inputs.



The fact that all neurons in a feature map share the same parameters dramatically reduces the number of parameters in the model. Moreover, once the CNN has learned to recognize a pattern in one location, it can recognize it in any other location. In contrast, once a regular DNN has learned to recognize a pattern in one location, it can recognize it only in that particular location.

Moreover, input images are also composed of multiple sublayers: one per *color channel*. There are typically three: red, green, and blue (RGB). Grayscale images have just

one channel, but some images may have much more—for example, satellite images that capture extra light frequencies (such as infrared).

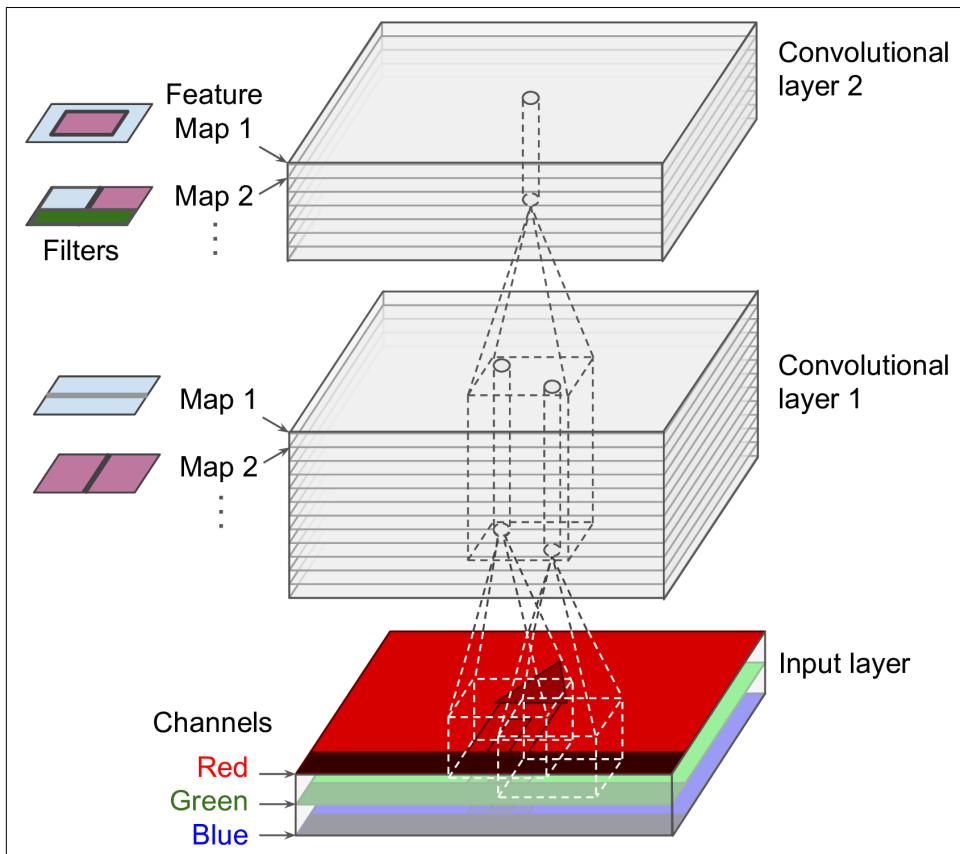

Figure 14-6. Convolution layers with multiple feature maps, and images with three color channels

Specifically, a neuron located in row i , column j of the feature map k in a given convolutional layer l is connected to the outputs of the neurons in the previous layer $l - 1$, located in rows $i \times s_h$ to $i \times s_h + f_h - 1$ and columns $j \times s_w$ to $j \times s_w + f_w - 1$, across all feature maps (in layer $l - 1$). Note that all neurons located in the same row i and column j but in different feature maps are connected to the outputs of the exact same neurons in the previous layer.

Equation 14-1 summarizes the preceding explanations in one big mathematical equation: it shows how to compute the output of a given neuron in a convolutional layer.

It is a bit ugly due to all the different indices, but all it does is calculate the weighted sum of all the inputs, plus the bias term.

Equation 14-1. Computing the output of a neuron in a convolutional layer

$$z_{i,j,k} = b_k + \sum_{u=0}^{f_h-1} \sum_{v=0}^{f_w-1} \sum_{k'=0}^{f_n-1} x_{i',j',k'} \cdot w_{u,v,k',k} \quad \text{with} \quad \begin{cases} i' = i \times s_h + u \\ j' = j \times s_w + v \end{cases}$$

- $z_{i,j,k}$ is the output of the neuron located in row i , column j in feature map k of the convolutional layer (layer l).
- As explained earlier, s_h and s_w are the vertical and horizontal strides, f_h and f_w are the height and width of the receptive field, and f_n is the number of feature maps in the previous layer (layer $l - 1$).
- $x_{i',j',k'}$ is the output of the neuron located in layer $l - 1$, row i' , column j' , feature map k' (or channel k' if the previous layer is the input layer).
- b_k is the bias term for feature map k (in layer l). You can think of it as a knob that tweaks the overall brightness of the feature map k .
- $w_{u,v,k',k}$ is the connection weight between any neuron in feature map k of the layer l and its input located at row u , column v (relative to the neuron's receptive field), and feature map k' .

TensorFlow Implementation

In TensorFlow, each input image is typically represented as a 3D tensor of shape [height, width, channels]. A mini-batch is represented as a 4D tensor of shape [mini-batch size, height, width, channels]. The weights of a convolutional layer are represented as a 4D tensor of shape [f_h, f_w, f_n, f_n]. The bias terms of a convolutional layer are simply represented as a 1D tensor of shape [f_n].

Let's look at a simple example. The following code loads two sample images, using Scikit-Learn's `load_sample_images()` (which loads two color images, one of a Chinese temple, and the other of a flower). The pixel intensities (for each color channel) is represented as a byte from 0 to 255, so we scale these features simply by dividing by 255, to get floats ranging from 0 to 1. Then we create two 7×7 filters (one with a vertical white line in the middle, and the other with a horizontal white line in the middle), and we apply them to both images using the `tf.nn.conv2d()` function, which is part of TensorFlow's low-level Deep Learning API. In this example, we use zero padding (`padding="SAME"`) and a stride of 2. Finally, we plot one of the resulting feature maps (similar to the top-right image in [Figure 14-5](#)).

```

from sklearn.datasets import load_sample_image

# Load sample images
china = load_sample_image("china.jpg") / 255
flower = load_sample_image("flower.jpg") / 255
images = np.array([china, flower])
batch_size, height, width, channels = images.shape

# Create 2 filters
filters = np.zeros(shape=(7, 7, channels, 2), dtype=np.float32)
filters[:, 3, :, 0] = 1 # vertical line
filters[3, :, :, 1] = 1 # horizontal line

outputs = tf.nn.conv2d(images, filters, strides=1, padding="SAME")

plt.imshow(outputs[0, :, :, 1], cmap="gray") # plot 1st image's 2nd feature map
plt.show()

```

Most of this code is self-explanatory, but the `tf.nn.conv2d()` line deserves a bit of explanation:

- `images` is the input mini-batch (a 4D tensor, as explained earlier).
- `filters` is the set of filters to apply (also a 4D tensor, as explained earlier).
- `strides` is equal to 1, but it could also be a 1D array with 4 elements, where the two central elements are the vertical and horizontal strides (s_h and s_w). The first and last elements must currently be equal to 1. They may one day be used to specify a batch stride (to skip some instances) and a channel stride (to skip some of the previous layer's feature maps or channels).
- `padding` must be either "VALID" or "SAME":
 - If set to "VALID", the convolutional layer does *not* use zero padding, and may ignore some rows and columns at the bottom and right of the input image, depending on the stride, as shown in [Figure 14-7](#) (for simplicity, only the horizontal dimension is shown here, but of course the same logic applies to the vertical dimension).
 - If set to "SAME", the convolutional layer uses zero padding if necessary. In this case, the number of output neurons is equal to the number of input neurons divided by the stride, rounded up (in this example, $13 / 5 = 2.6$, rounded up to 3). Then zeros are added as evenly as possible around the inputs.

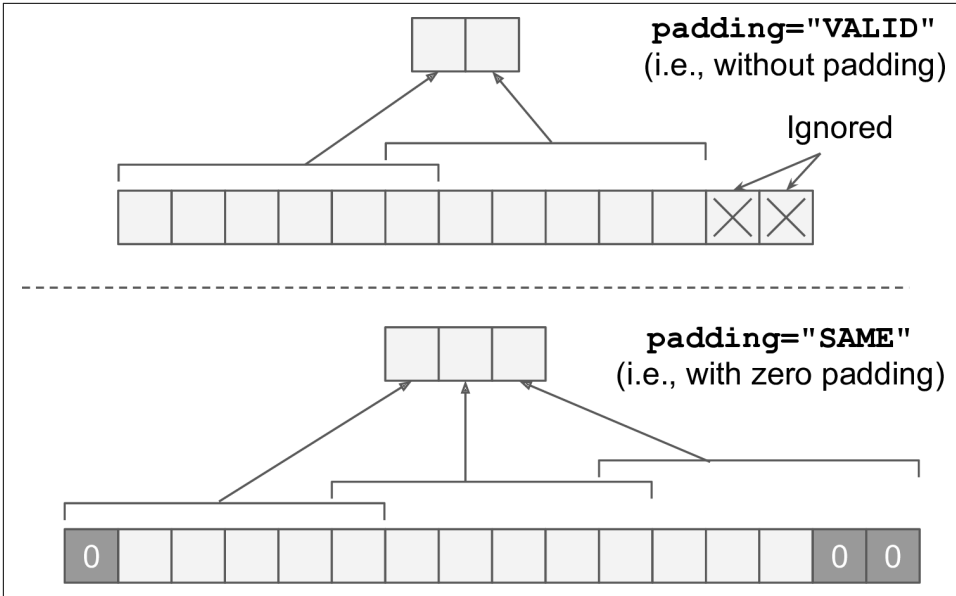

Figure 14-7. Padding options—input width: 13, filter width: 6, stride: 5

In this example, we manually defined the filters, but in a real CNN you would normally define filters as trainable variables, so the neural net can learn which filters work best, as explained earlier. Instead of manually creating the variables, however, you can simply use the `keras.layers.Conv2D` layer:

```
conv = keras.layers.Conv2D(filters=32, kernel_size=3, strides=1,
                           padding="SAME", activation="relu")
```

This code creates a `Conv2D` layer with 32 filters, each 3×3 , using a stride of 1 (both horizontally and vertically), `SAME` padding, and applying the `ReLU` activation function to its outputs. As you can see, convolutional layers have quite a few hyperparameters: you must choose the number of filters, their height and width, the strides, and the padding type. As always, you can use cross-validation to find the right hyperparameter values, but this is very time-consuming. We will discuss common CNN architectures later, to give you some idea of what hyperparameter values work best in practice.

Memory Requirements

Another problem with CNNs is that the convolutional layers require a huge amount of RAM. This is especially true during training, because the reverse pass of backpropagation requires all the intermediate values computed during the forward pass.

For example, consider a convolutional layer with 5×5 filters, outputting 200 feature maps of size 150×100 , with stride 1 and `SAME` padding. If the input is a 150×100

RGB image (three channels), then the number of parameters is $(5 \times 5 \times 3 + 1) \times 200 = 15,200$ (the +1 corresponds to the bias terms), which is fairly small compared to a fully connected layer.⁷ However, each of the 200 feature maps contains 150×100 neurons, and each of these neurons needs to compute a weighted sum of its $5 \times 5 \times 3 = 75$ inputs: that's a total of 225 million float multiplications. Not as bad as a fully connected layer, but still quite computationally intensive. Moreover, if the feature maps are represented using 32-bit floats, then the convolutional layer's output will occupy $200 \times 150 \times 100 \times 32 = 96$ million bits (12 MB) of RAM.⁸ And that's just for one instance! If a training batch contains 100 instances, then this layer will use up 1.2 GB of RAM!

During inference (i.e., when making a prediction for a new instance) the RAM occupied by one layer can be released as soon as the next layer has been computed, so you only need as much RAM as required by two consecutive layers. But during training everything computed during the forward pass needs to be preserved for the reverse pass, so the amount of RAM needed is (at least) the total amount of RAM required by all layers.



If training crashes because of an out-of-memory error, you can try reducing the mini-batch size. Alternatively, you can try reducing dimensionality using a stride, or removing a few layers. Or you can try using 16-bit floats instead of 32-bit floats. Or you could distribute the CNN across multiple devices.

Now let's look at the second common building block of CNNs: the *pooling layer*.

Pooling Layer

Once you understand how convolutional layers work, the pooling layers are quite easy to grasp. Their goal is to *subsample* (i.e., shrink) the input image in order to reduce the computational load, the memory usage, and the number of parameters (thereby limiting the risk of overfitting).

Just like in convolutional layers, each neuron in a pooling layer is connected to the outputs of a limited number of neurons in the previous layer, located within a small rectangular receptive field. You must define its size, the stride, and the padding type, just like before. However, a pooling neuron has no weights; all it does is aggregate the inputs using an aggregation function such as the max or mean. **Figure 14-8** shows a *max pooling layer*, which is the most common type of pooling layer. In this example,

⁷ A fully connected layer with 150×100 neurons, each connected to all $150 \times 100 \times 3$ inputs, would have $150^2 \times 100^2 \times 3 = 675$ million parameters!

⁸ In the international system of units (SI), $1 \text{ MB} = 1,000 \text{ kB} = 1,000 \times 1,000 \text{ bytes} = 1,000 \times 1,000 \times 8 \text{ bits}$.

we use a 2×2 pooling kernel⁹, with a stride of 2, and no padding. Only the max input value in each receptive field makes it to the next layer, while the other inputs are dropped. For example, in the lower left receptive field in Figure 14-8, the input values are 1, 5, 3, 2, so only the max value, 5, is propagated to the next layer. Because of the stride of 2, the output image has half the height and half the width of the input image (rounded down since we use no padding).

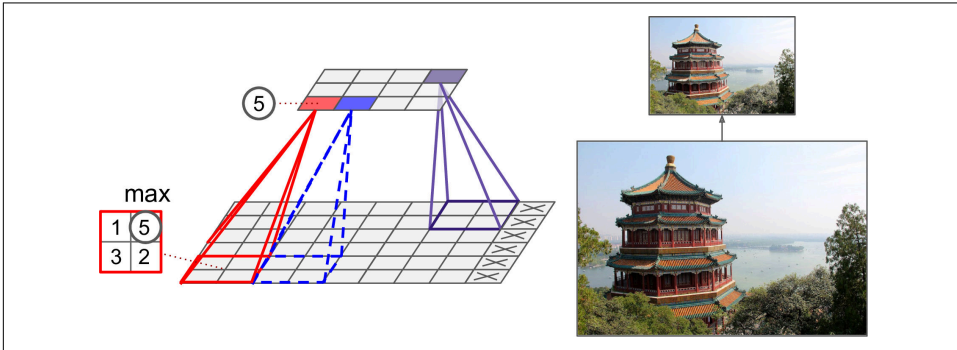

Figure 14-8. Max pooling layer (2×2 pooling kernel, stride 2, no padding)



A pooling layer typically works on every input channel independently, so the output depth is the same as the input depth.

Other than reducing computations, memory usage and the number of parameters, a max pooling layer also introduces some level of *invariance* to small translations, as shown in Figure 14-9. Here we assume that the bright pixels have a lower value than dark pixels, and we consider 3 images (A, B, C) going through a max pooling layer with a 2×2 kernel and stride 2. Images B and C are the same as image A, but shifted by one and two pixels to the right. As you can see, the outputs of the max pooling layer for images A and B are identical. This is what translation invariance means. However, for image C, the output is different: it is shifted by one pixel to the right (but there is still 75% invariance). By inserting a max pooling layer every few layers in a CNN, it is possible to get some level of translation invariance at a larger scale. Moreover, max pooling also offers a small amount of rotational invariance and a slight scale invariance. Such invariance (even if it is limited) can be useful in cases where the prediction should not depend on these details, such as in classification tasks.

⁹ Other kernels we discussed so far had weights, but pooling kernels do not: they are just stateless sliding windows.

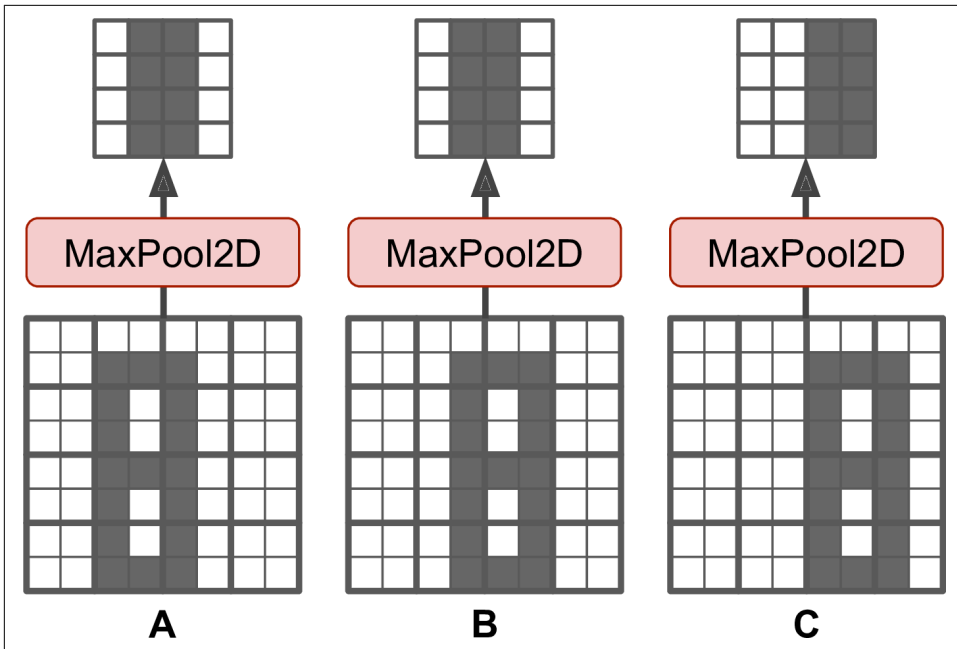

Figure 14-9. Invariance to small translations

But max pooling has some downsides: firstly, it is obviously very destructive: even with a tiny 2×2 kernel and a stride of 2, the output will be two times smaller in both directions (so its area will be four times smaller), simply dropping 75% of the input values. And in some applications, invariance is not desirable, for example for *semantic segmentation*: this is the task of classifying each pixel in an image depending on the object that pixel belongs to: obviously, if the input image is translated by 1 pixel to the right, the output should also be translated by 1 pixel to the right. The goal in this case is *equivariance*, not invariance: a small change to the inputs should lead to a corresponding small change in the output.

TensorFlow Implementation

Implementing a max pooling layer in TensorFlow is quite easy. The following code creates a max pooling layer using a 2×2 kernel. The strides default to the kernel size, so this layer will use a stride of 2 (both horizontally and vertically). By default, it uses VALID padding (i.e., no padding at all):

```
max_pool = keras.layers.MaxPool2D(pool_size=2)
```

To create an *average pooling layer*, just use AvgPool2D instead of MaxPool2D. As you might expect, it works exactly like a max pooling layer, except it computes the mean rather than the max. Average pooling layers used to be very popular, but people

mostly use max pooling layers now, as they generally perform better. This may seem surprising, since computing the mean generally loses less information than computing the max. But on the other hand, max pooling preserves only the strongest feature, getting rid of all the meaningless ones, so the next layers get a cleaner signal to work with. Moreover, max pooling offers stronger translation invariance than average pooling.

Note that max pooling and average pooling can be performed along the depth dimension rather than the spatial dimensions, although this is not as common. This can allow the CNN to learn to be invariant to various features. For example, it could learn multiple filters, each detecting a different rotation of the same pattern, such as handwritten digits (see Figure 14-10), and the depth-wise max pooling layer would ensure that the output is the same regardless of the rotation. The CNN could similarly learn to be invariant to anything else: thickness, brightness, skew, color, and so on.

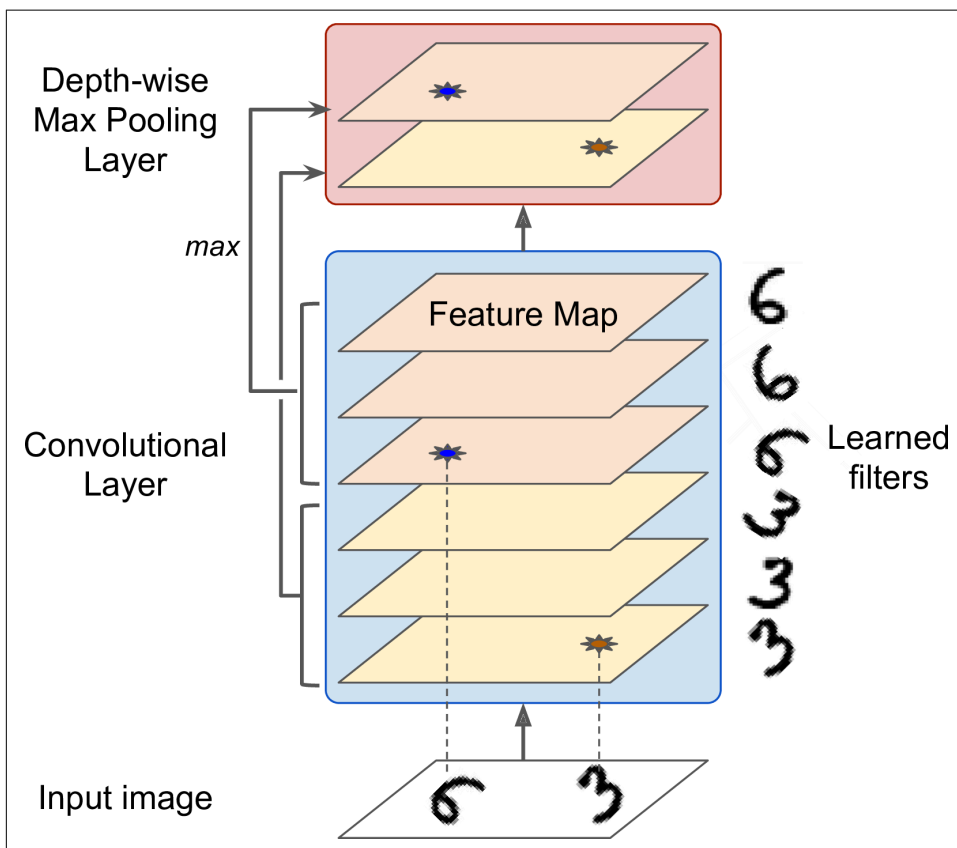

Figure 14-10. Depth-wise max pooling can help the CNN learn any invariance

Keras does not include a depth-wise max pooling layer, but TensorFlow's low-level Deep Learning API does: just use the `tf.nn.max_pool()` function, and specify the kernel size and strides as 4-tuples. The first three values of each should be 1: this indicates that the kernel size and stride along the batch, height and width dimensions should be 1. The last value should be whatever kernel size and stride you want along the depth dimension, for example 3 (this must be a divisor of the input depth; for example, it will not work if the previous layer outputs 20 feature maps, since 20 is not a multiple of 3):

```
output = tf.nn.max_pool(images,
                        ksize=(1, 1, 1, 3),
                        strides=(1, 1, 1, 3),
                        padding="VALID")
```

If you want to include this as a layer in your Keras models, you can simply wrap it in a Lambda layer (or create a custom Keras layer):

```
depth_pool = keras.layers.Lambda(
    lambda X: tf.nn.max_pool(X, ksize=(1, 1, 1, 3), strides=(1, 1, 1, 3),
                             padding="VALID"))
```

One last type of pooling layer that you will often see in modern architectures is the *global average pooling* layer. It works very differently: all it does is compute the mean of each entire feature map (it's like an average pooling layer using a pooling kernel with the same spatial dimensions as the inputs). This means that it just outputs a single number per feature map and per instance. Although this is of course extremely destructive (most of the information in the feature map is lost), it can be useful as the output layer, as we will see later in this chapter. To create such a layer, simply use the `keras.layers.GlobalAvgPool2D` class:

```
global_avg_pool = keras.layers.GlobalAvgPool2D()
```

It is actually equivalent to this simple Lambda layer, which computes the mean over the spatial dimensions (height and width):

```
global_avg_pool = keras.layers.Lambda(lambda X: tf.reduce_mean(X, axis=[1, 2]))
```

Now you know all the building blocks to create a convolutional neural network. Let's see how to assemble them.

CNN Architectures

Typical CNN architectures stack a few convolutional layers (each one generally followed by a ReLU layer), then a pooling layer, then another few convolutional layers (+ReLU), then another pooling layer, and so on. The image gets smaller and smaller as it progresses through the network, but it also typically gets deeper and deeper (i.e., with more feature maps) thanks to the convolutional layers (see [Figure 14-11](#)). At the top of the stack, a regular feedforward neural network is added, composed of a few

fully connected layers (+ReLU), and the final layer outputs the prediction (e.g., a softmax layer that outputs estimated class probabilities).

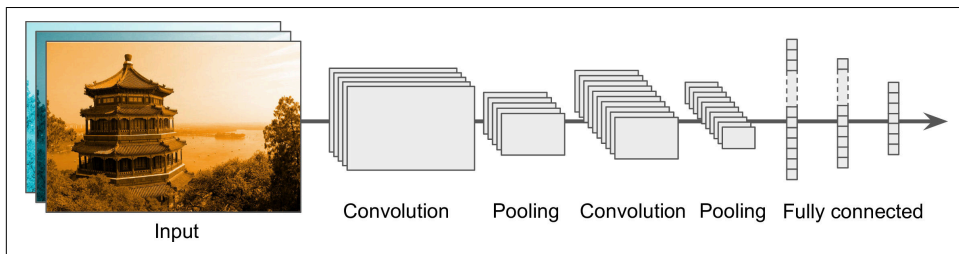

Figure 14-11. Typical CNN architecture



A common mistake is to use convolution kernels that are too large. For example, instead of using a convolutional layer with a 5×5 kernel, it is generally preferable to stack two layers with 3×3 kernels: it will use less parameters and require less computations, and it will usually perform better. One exception to this recommendation is for the first convolutional layer: it can typically have a large kernel (e.g., 5×5), usually with stride of 2 or more: this will reduce the spatial dimension of the image without losing too much information, and since the input image only has 3 channels in general, it will not be too costly.

Here is how you can implement a simple CNN to tackle the fashion MNIST dataset (introduced in [Chapter 10](#)):

```
from functools import partial

DefaultConv2D = partial(keras.layers.Conv2D,
                       kernel_size=3, activation='relu', padding="SAME")

model = keras.models.Sequential([
    DefaultConv2D(filters=64, kernel_size=7, input_shape=[28, 28, 1]),
    keras.layers.MaxPooling2D(pool_size=2),
    DefaultConv2D(filters=128),
    DefaultConv2D(filters=128),
    keras.layers.MaxPooling2D(pool_size=2),
    DefaultConv2D(filters=256),
    DefaultConv2D(filters=256),
    keras.layers.MaxPooling2D(pool_size=2),
    keras.layers.Flatten(),
    keras.layers.Dense(units=128, activation='relu'),
    keras.layers.Dropout(0.5),
    keras.layers.Dense(units=64, activation='relu'),
    keras.layers.Dropout(0.5),
    keras.layers.Dense(units=10, activation='softmax'),
])
```

- In this code, we start by using the `partial()` function to define a thin wrapper around the `Conv2D` class, called `DefaultConv2D`: it simply avoids having to repeat the same hyperparameter values over and over again.
- The first layer uses a large kernel size, but no stride because the input images are not very large. It also sets `input_shape=[28, 28, 1]`, which means the images are 28×28 pixels, with a single color channel (i.e., grayscale).
- Next, we have a max pooling layer, which divides each spatial dimension by a factor of two (since `pool_size=2`).
- Then we repeat the same structure twice: two convolutional layers followed by a max pooling layer. For larger images, we could repeat this structure several times (the number of repetitions is a hyperparameter you can tune).
- Note that the number of filters grows as we climb up the CNN towards the output layer (it is initially 64, then 128, then 256): it makes sense for it to grow, since the number of low level features is often fairly low (e.g., small circles, horizontal lines, etc.), but there are many different ways to combine them into higher level features. It is a common practice to double the number of filters after each pooling layer: since a pooling layer divides each spatial dimension by a factor of 2, we can afford doubling the number of feature maps in the next layer, without fear of exploding the number of parameters, memory usage, or computational load.
- Next is the fully connected network, composed of 2 hidden dense layers and a dense output layer. Note that we must flatten its inputs, since a dense network expects a 1D array of features for each instance. We also add two dropout layers, with a dropout rate of 50% each, to reduce overfitting.

This CNN reaches over 92% accuracy on the test set. It's not the state of the art, but it is pretty good, and clearly much better than what we achieved with dense networks in [Chapter 10](#).

Over the years, variants of this fundamental architecture have been developed, leading to amazing advances in the field. A good measure of this progress is the error rate in competitions such as the ILSVRC [ImageNet challenge](#). In this competition the top-5 error rate for image classification fell from over 26% to less than 2.3% in just six years. The top-five error rate is the number of test images for which the system's top 5 predictions did not include the correct answer. The images are large (256 pixels high) and there are 1,000 classes, some of which are really subtle (try distinguishing 120 dog breeds). Looking at the evolution of the winning entries is a good way to understand how CNNs work.

We will first look at the classical LeNet-5 architecture (1998), then three of the winners of the ILSVRC challenge: AlexNet (2012), GoogLeNet (2014), and ResNet (2015).

LeNet-5

The **LeNet-5 architecture**¹⁰ is perhaps the most widely known CNN architecture. As mentioned earlier, it was created by Yann LeCun in 1998 and widely used for handwritten digit recognition (MNIST). It is composed of the layers shown in **Table 14-1**.

Table 14-1. LeNet-5 architecture

Layer	Type	Maps	Size	Kernel size	Stride	Activation
Out	Fully Connected	–	10	–	–	RBF
F6	Fully Connected	–	84	–	–	tanh
C5	Convolution	120	1 × 1	5 × 5	1	tanh
S4	Avg Pooling	16	5 × 5	2 × 2	2	tanh
C3	Convolution	16	10 × 10	5 × 5	1	tanh
S2	Avg Pooling	6	14 × 14	2 × 2	2	tanh
C1	Convolution	6	28 × 28	5 × 5	1	tanh
In	Input	1	32 × 32	–	–	–

There are a few extra details to be noted:

- MNIST images are 28×28 pixels, but they are zero-padded to 32×32 pixels and normalized before being fed to the network. The rest of the network does not use any padding, which is why the size keeps shrinking as the image progresses through the network.
- The average pooling layers are slightly more complex than usual: each neuron computes the mean of its inputs, then multiplies the result by a learnable coefficient (one per map) and adds a learnable bias term (again, one per map), then finally applies the activation function.
- Most neurons in C3 maps are connected to neurons in only three or four S2 maps (instead of all six S2 maps). See table 1 (page 8) in the original paper¹⁰ for details.
- The output layer is a bit special: instead of computing the matrix multiplication of the inputs and the weight vector, each neuron outputs the square of the Euclidean distance between its input vector and its weight vector. Each output measures how much the image belongs to a particular digit class. The cross entropy cost function is now preferred, as it penalizes bad predictions much more, producing larger gradients and converging faster.

¹⁰ “Gradient-Based Learning Applied to Document Recognition”, Y. LeCun, L. Bottou, Y. Bengio and P. Haffner (1998).

Yann LeCun’s [website](#) (“LENET” section) features great demos of LeNet-5 classifying digits.

AlexNet

The *AlexNet CNN architecture*¹¹ won the 2012 ImageNet ILSVRC challenge by a large margin: it achieved 17% top-5 error rate while the second best achieved only 26%! It was developed by Alex Krizhevsky (hence the name), Ilya Sutskever, and Geoffrey Hinton. It is quite similar to LeNet-5, only much larger and deeper, and it was the first to stack convolutional layers directly on top of each other, instead of stacking a pooling layer on top of each convolutional layer. [Table 14-2](#) presents this architecture.

Table 14-2. AlexNet architecture

Layer	Type	Maps	Size	Kernel size	Stride	Padding	Activation
Out	Fully Connected	–	1,000	–	–	–	Softmax
F9	Fully Connected	–	4,096	–	–	–	ReLU
F8	Fully Connected	–	4,096	–	–	–	ReLU
C7	Convolution	256	13 × 13	3 × 3	1	SAME	ReLU
C6	Convolution	384	13 × 13	3 × 3	1	SAME	ReLU
C5	Convolution	384	13 × 13	3 × 3	1	SAME	ReLU
S4	Max Pooling	256	13 × 13	3 × 3	2	VALID	–
C3	Convolution	256	27 × 27	5 × 5	1	SAME	ReLU
S2	Max Pooling	96	27 × 27	3 × 3	2	VALID	–
C1	Convolution	96	55 × 55	11 × 11	4	VALID	ReLU
In	Input	3 (RGB)	227 × 227	–	–	–	–

To reduce overfitting, the authors used two regularization techniques: first they applied dropout (introduced in [Chapter 11](#)) with a 50% dropout rate during training to the outputs of layers F8 and F9. Second, they performed *data augmentation* by randomly shifting the training images by various offsets, flipping them horizontally, and changing the lighting conditions.

Data Augmentation

Data augmentation artificially increases the size of the training set by generating many realistic variants of each training instance. This reduces overfitting, making this a regularization technique. The generated instances should be as realistic as possible:

¹¹ “ImageNet Classification with Deep Convolutional Neural Networks,” A. Krizhevsky et al. (2012).

ideally, given an image from the augmented training set, a human should not be able to tell whether it was augmented or not. Moreover, simply adding white noise will not help; the modifications should be learnable (white noise is not).

For example, you can slightly shift, rotate, and resize every picture in the training set by various amounts and add the resulting pictures to the training set (see [Figure 14-12](#)). This forces the model to be more tolerant to variations in the position, orientation, and size of the objects in the pictures. If you want the model to be more tolerant to different lighting conditions, you can similarly generate many images with various contrasts. In general, you can also flip the pictures horizontally (except for text, and other non-symmetrical objects). By combining these transformations you can greatly increase the size of your training set.

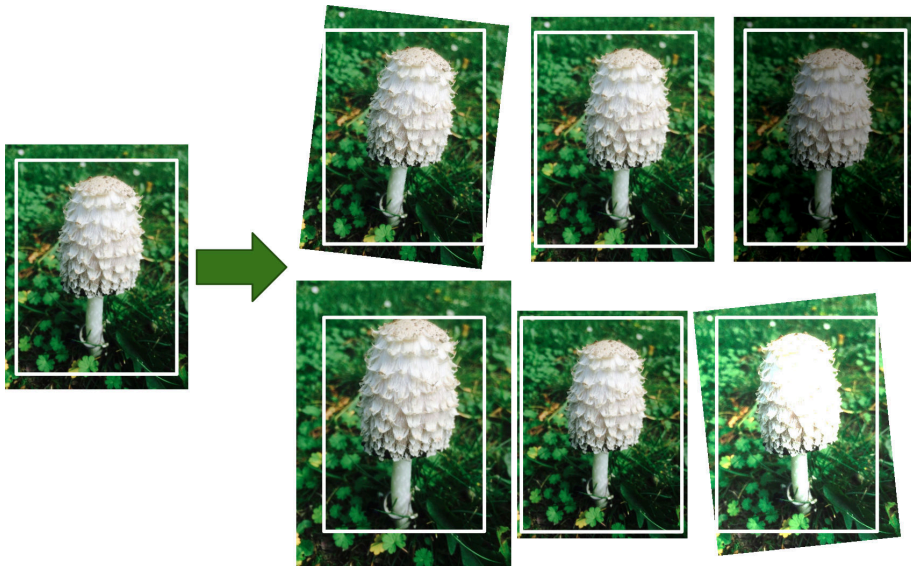

Figure 14-12. Generating new training instances from existing ones

AlexNet also uses a competitive normalization step immediately after the ReLU step of layers C1 and C3, called *local response normalization*. The most strongly activated neurons inhibit other neurons located at the same position in neighboring feature maps (such competitive activation has been observed in biological neurons). This encourages different feature maps to specialize, pushing them apart and forcing them

to explore a wider range of features, ultimately improving generalization. Equation 14-2 shows how to apply LRN.

Equation 14-2. Local response normalization

$$b_i = a_i \left(k + \alpha \sum_{j=j_{\text{low}}}^{j_{\text{high}}} a_j^2 \right)^{-\beta} \quad \text{with} \quad \begin{cases} j_{\text{high}} = \min \left(i + \frac{r}{2}, f_n - 1 \right) \\ j_{\text{low}} = \max \left(0, i - \frac{r}{2} \right) \end{cases}$$

- b_i is the normalized output of the neuron located in feature map i , at some row u and column v (note that in this equation we consider only neurons located at this row and column, so u and v are not shown).
- a_i is the activation of that neuron after the ReLU step, but before normalization.
- k , α , β , and r are hyperparameters. k is called the *bias*, and r is called the *depth radius*.
- f_n is the number of feature maps.

For example, if $r = 2$ and a neuron has a strong activation, it will inhibit the activation of the neurons located in the feature maps immediately above and below its own.

In AlexNet, the hyperparameters are set as follows: $r = 2$, $\alpha = 0.00002$, $\beta = 0.75$, and $k = 1$. This step can be implemented using the `tf.nn.local_response_normalization()` function (which you can wrap in a `Lambda` layer if you want to use it in a Keras model).

A variant of AlexNet called *ZF Net* was developed by Matthew Zeiler and Rob Fergus and won the 2013 ILSVRC challenge. It is essentially AlexNet with a few tweaked hyperparameters (number of feature maps, kernel size, stride, etc.).

GoogLeNet

The **GoogLeNet architecture** was developed by Christian Szegedy et al. from Google Research,¹² and it won the ILSVRC 2014 challenge by pushing the top-5 error rate below 7%. This great performance came in large part from the fact that the network was much deeper than previous CNNs (see Figure 14-14). This was made possible by sub-networks called *inception modules*,¹³ which allow GoogLeNet to use parameters

¹² “Going Deeper with Convolutions,” C. Szegedy et al. (2015).

¹³ In the 2010 movie *Inception*, the characters keep going deeper and deeper into multiple layers of dreams, hence the name of these modules.

much more efficiently than previous architectures: GoogLeNet actually has 10 times fewer parameters than AlexNet (roughly 6 million instead of 60 million).

Figure 14-13 shows the architecture of an inception module. The notation “ $3 \times 3 + 1(S)$ ” means that the layer uses a 3×3 kernel, stride 1, and SAME padding. The input signal is first copied and fed to four different layers. All convolutional layers use the ReLU activation function. Note that the second set of convolutional layers uses different kernel sizes (1×1 , 3×3 , and 5×5), allowing them to capture patterns at different scales. Also note that every single layer uses a stride of 1 and SAME padding (even the max pooling layer), so their outputs all have the same height and width as their inputs. This makes it possible to concatenate all the outputs along the depth dimension in the final *depth concat layer* (i.e., stack the feature maps from all four top convolutional layers). This concatenation layer can be implemented in TensorFlow using the `tf.concat()` operation, with `axis=3` (axis 3 is the depth).

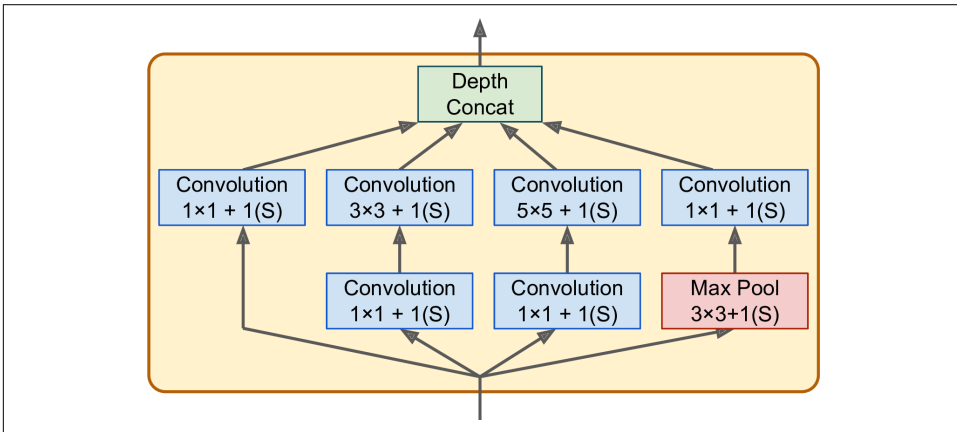

Figure 14-13. Inception module

You may wonder why inception modules have convolutional layers with 1×1 kernels. Surely these layers cannot capture any features since they look at only one pixel at a time? In fact, these layers serve three purposes:

- First, although they cannot capture spatial patterns, they can capture patterns along the depth dimension.
- Second, they are configured to output fewer feature maps than their inputs, so they serve as *bottleneck layers*, meaning they reduce dimensionality. This cuts the computational cost and the number of parameters, speeding up training and improving generalization.
- Lastly, each pair of convolutional layers ($[1 \times 1, 3 \times 3]$ and $[1 \times 1, 5 \times 5]$) acts like a single, powerful convolutional layer, capable of capturing more complex patterns. Indeed, instead of sweeping a simple linear classifier across the image (as a

single convolutional layer does), this pair of convolutional layers sweeps a two-layer neural network across the image.

In short, you can think of the whole inception module as a convolutional layer on steroids, able to output feature maps that capture complex patterns at various scales.



The number of convolutional kernels for each convolutional layer is a hyperparameter. Unfortunately, this means that you have six more hyperparameters to tweak for every inception layer you add.

Now let's look at the architecture of the GoogLeNet CNN (see [Figure 14-14](#)). The number of feature maps output by each convolutional layer and each pooling layer is shown before the kernel size. The architecture is so deep that it has to be represented in three columns, but GoogLeNet is actually one tall stack, including nine inception modules (the boxes with the spinning tops). The six numbers in the inception modules represent the number of feature maps output by each convolutional layer in the module (in the same order as in [Figure 14-13](#)). Note that all the convolutional layers use the ReLU activation function.

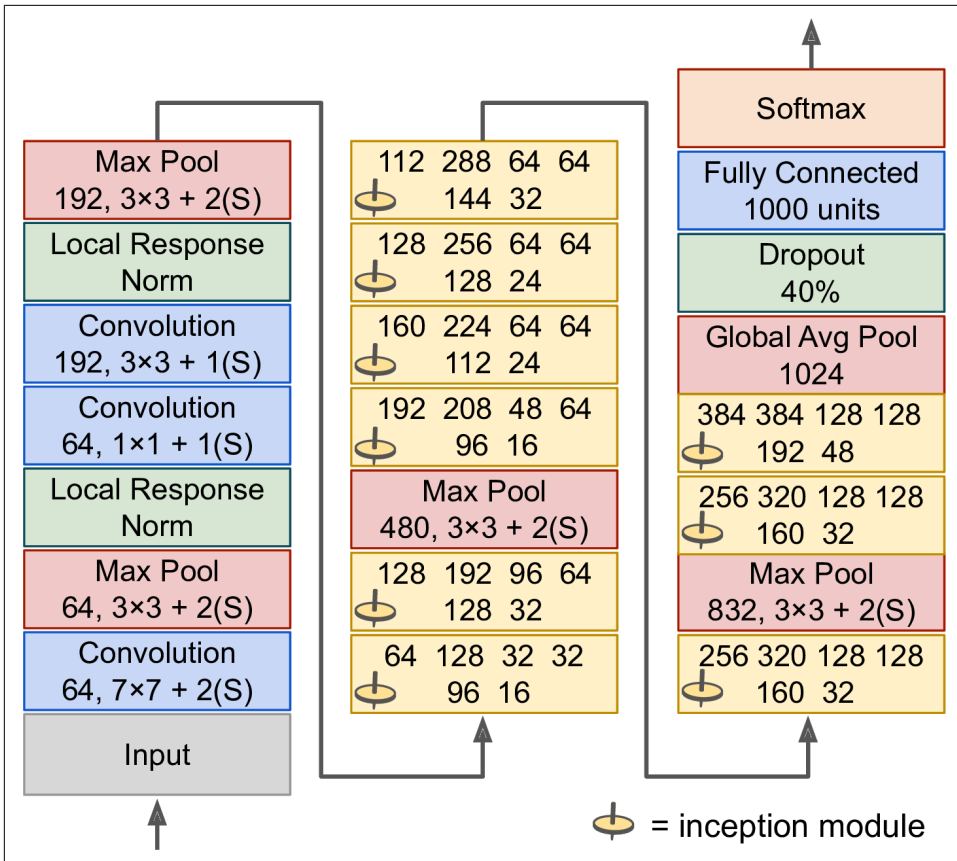

Figure 14-14. GoogLeNet architecture

Let's go through this network:

- The first two layers divide the image's height and width by 4 (so its area is divided by 16), to reduce the computational load. The first layer uses a large kernel size, so that much of the information is still preserved.
- Then the local response normalization layer ensures that the previous layers learn a wide variety of features (as discussed earlier).
- Two convolutional layers follow, where the first acts like a *bottleneck layer*. As explained earlier, you can think of this pair as a single smarter convolutional layer.
- Again, a local response normalization layer ensures that the previous layers capture a wide variety of patterns.

- Next a max pooling layer reduces the image height and width by 2, again to speed up computations.
- Then comes the tall stack of nine inception modules, interleaved with a couple max pooling layers to reduce dimensionality and speed up the net.
- Next, the global average pooling layer simply outputs the mean of each feature map: this drops any remaining spatial information, which is fine since there was not much spatial information left at that point. Indeed, GoogLeNet input images are typically expected to be 224×224 pixels, so after 5 max pooling layers, each dividing the height and width by 2, the feature maps are down to 7×7 . Moreover, it is a classification task, not localization, so it does not matter where the object is. Thanks to the dimensionality reduction brought by this layer, there is no need to have several fully connected layers at the top of the CNN (like in AlexNet), and this considerably reduces the number of parameters in the network and limits the risk of overfitting.
- The last layers are self-explanatory: dropout for regularization, then a fully connected layer with 1,000 units, since there are a 1,000 classes, and a softmax activation function to output estimated class probabilities.

This diagram is slightly simplified: the original GoogLeNet architecture also included two auxiliary classifiers plugged on top of the third and sixth inception modules. They were both composed of one average pooling layer, one convolutional layer, two fully connected layers, and a softmax activation layer. During training, their loss (scaled down by 70%) was added to the overall loss. The goal was to fight the vanishing gradients problem and regularize the network. However, it was later shown that their effect was relatively minor.

Several variants of the GoogLeNet architecture were later proposed by Google researchers, including Inception-v3 and Inception-v4, using slightly different inception modules, and reaching even better performance.

VGGNet

The runner up in the ILSVRC 2014 challenge was **VGGNet**¹⁴, developed by K. Simonyan and A. Zisserman. It had a very simple and classical architecture, with 2 or 3 convolutional layers, a pooling layer, then again 2 or 3 convolutional layers, a pooling layer, and so on (with a total of just 16 convolutional layers), plus a final dense network with 2 hidden layers and the output layer. It used only 3×3 filters, but many filters.

¹⁴ “Very Deep Convolutional Networks for Large-Scale Image Recognition,” K. Simonyan and A. Zisserman (2015).

ResNet

The ILSVRC 2015 challenge was won using a *Residual Network* (or *ResNet*), developed by Kaiming He et al.,¹⁵ which delivered an astounding top-5 error rate under 3.6%, using an extremely deep CNN composed of 152 layers. It confirmed the general trend: models are getting deeper and deeper, with fewer and fewer parameters. The key to being able to train such a deep network is to use *skip connections* (also called *shortcut connections*): the signal feeding into a layer is also added to the output of a layer located a bit higher up the stack. Let's see why this is useful.

When training a neural network, the goal is to make it model a target function $h(\mathbf{x})$. If you add the input \mathbf{x} to the output of the network (i.e., you add a skip connection), then the network will be forced to model $f(\mathbf{x}) = h(\mathbf{x}) - \mathbf{x}$ rather than $h(\mathbf{x})$. This is called *residual learning* (see Figure 14-15).

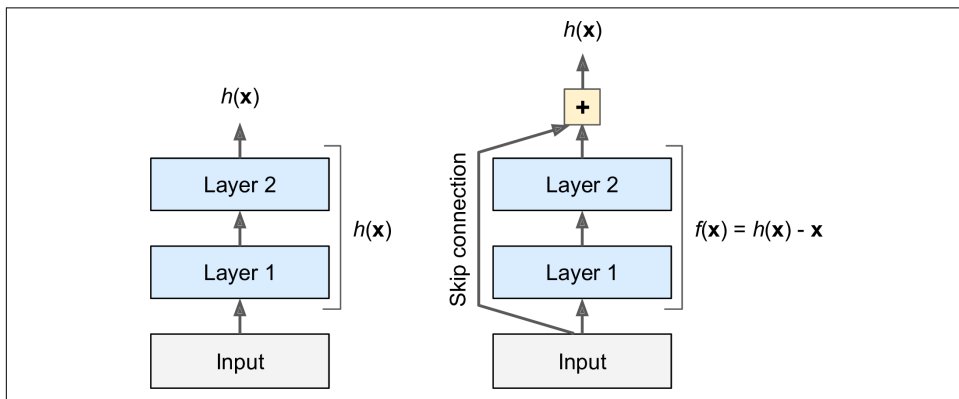

Figure 14-15. Residual learning

When you initialize a regular neural network, its weights are close to zero, so the network just outputs values close to zero. If you add a skip connection, the resulting network just outputs a copy of its inputs; in other words, it initially models the identity function. If the target function is fairly close to the identity function (which is often the case), this will speed up training considerably.

Moreover, if you add many skip connections, the network can start making progress even if several layers have not started learning yet (see Figure 14-16). Thanks to skip connections, the signal can easily make its way across the whole network. The deep residual network can be seen as a stack of *residual units*, where each residual unit is a small neural network with a skip connection.

¹⁵ "Deep Residual Learning for Image Recognition," K. He (2015).

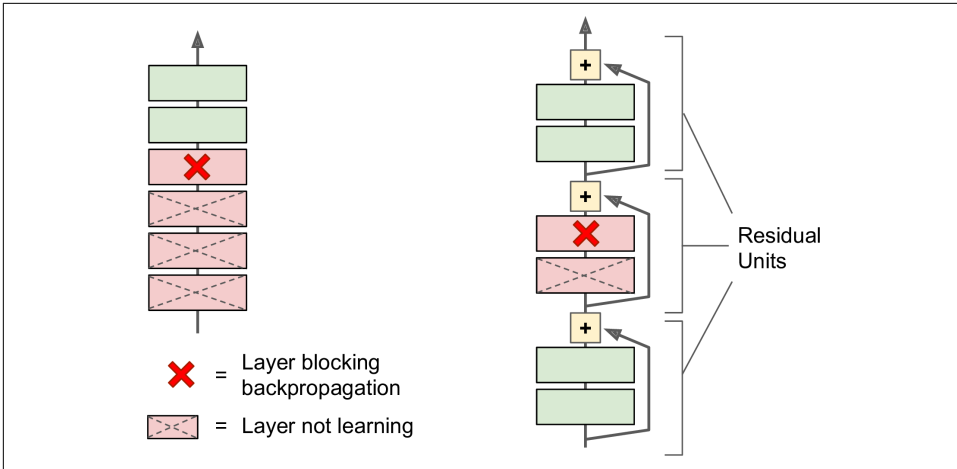

Figure 14-16. Regular deep neural network (left) and deep residual network (right)

Now let's look at ResNet's architecture (see Figure 14-17). It is actually surprisingly simple. It starts and ends exactly like GoogLeNet (except without a dropout layer), and in between is just a very deep stack of simple residual units. Each residual unit is composed of two convolutional layers (and no pooling layer!), with Batch Normalization (BN) and ReLU activation, using 3×3 kernels and preserving spatial dimensions (stride 1, SAME padding).

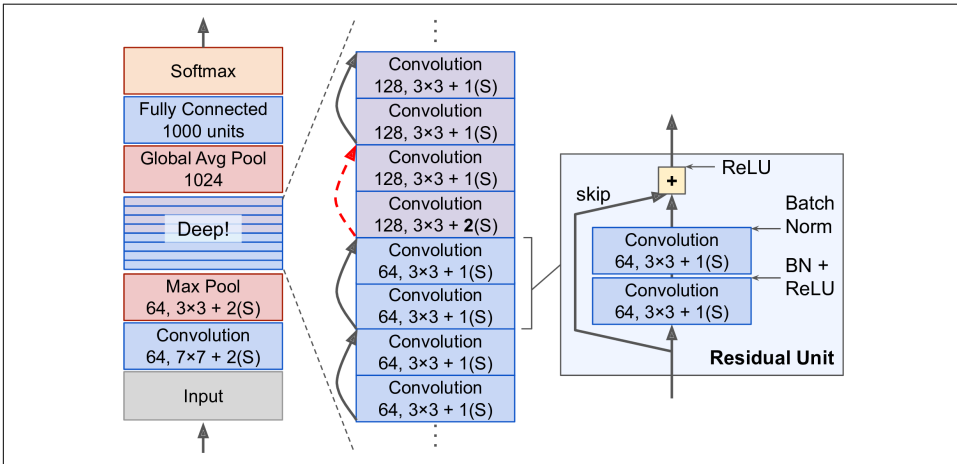

Figure 14-17. ResNet architecture

Note that the number of feature maps is doubled every few residual units, at the same time as their height and width are halved (using a convolutional layer with stride 2). When this happens the inputs cannot be added directly to the outputs of the residual unit since they don't have the same shape (for example, this problem affects the skip

connection represented by the dashed arrow in [Figure 14-17](#)). To solve this problem, the inputs are passed through a 1×1 convolutional layer with stride 2 and the right number of output feature maps (see [Figure 14-18](#)).

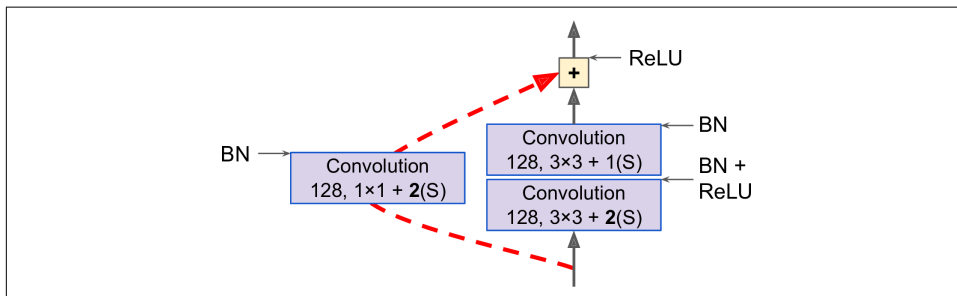

Figure 14-18. Skip connection when changing feature map size and depth

ResNet-34 is the ResNet with 34 layers (only counting the convolutional layers and the fully connected layer) containing three residual units that output 64 feature maps, 4 RUs with 128 maps, 6 RUs with 256 maps, and 3 RUs with 512 maps. We will implement this architecture later in this chapter.

ResNets deeper than that, such as ResNet-152, use slightly different residual units. Instead of two 3×3 convolutional layers with (say) 256 feature maps, they use three convolutional layers: first a 1×1 convolutional layer with just 64 feature maps (4 times less), which acts as a bottleneck layer (as discussed already), then a 3×3 layer with 64 feature maps, and finally another 1×1 convolutional layer with 256 feature maps (4 times 64) that restores the original depth. ResNet-152 contains three such RUs that output 256 maps, then 8 RUs with 512 maps, a whopping 36 RUs with 1,024 maps, and finally 3 RUs with 2,048 maps.



Google's [Inception-v4](#)¹⁶ architecture merged the ideas of GoogLeNet and ResNet and achieved close to 3% top-5 error rate on ImageNet classification.

Xception

Another variant of the GoogLeNet architecture is also worth noting: [Xception](#)¹⁷ (which stands for *Extreme Inception*) was proposed in 2016 by François Chollet (the

¹⁶ "Inception-v4, Inception-ResNet and the Impact of Residual Connections on Learning," C. Szegedy et al. (2016).

¹⁷ "Xception: Deep Learning with Depthwise Separable Convolutions," François Chollet (2016)

author of Keras), and it significantly outperformed Inception-v3 on a huge vision task (350 million images and 17,000 classes). Just like Inception-v4, it also merges the ideas of GoogLeNet and ResNet, but it replaces the inception modules with a special type of layer called a *depthwise separable convolution* (or *separable convolution* for short¹⁸). These layers had been used before in some CNN architectures, but they were not as central as in the Xception architecture. While a regular convolutional layer uses filters that try to simultaneously capture spatial patterns (e.g., an oval) and cross-channel patterns (e.g., mouth + nose + eyes = face), a separable convolutional layer makes the strong assumption that spatial patterns and cross-channel patterns can be modeled separately (see Figure 14-19). Thus, it is composed of two parts: the first part applies a single spatial filter for each input feature map, then the second part looks exclusively for cross-channel patterns—it is just a regular convolutional layer with 1×1 filters.

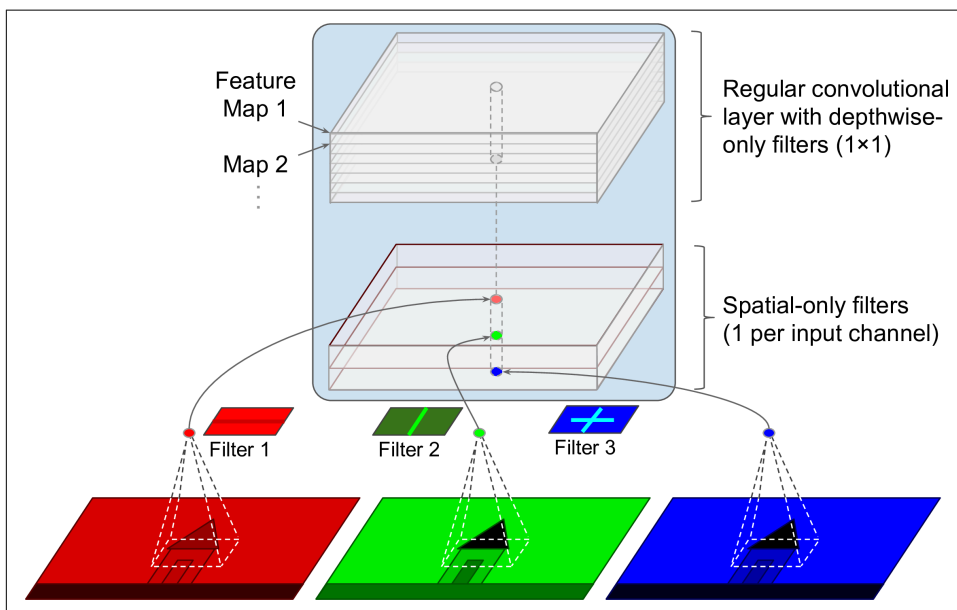

Figure 14-19. Depthwise Separable Convolutional Layer

Since separable convolutional layers only have one spatial filter per input channel, you should avoid using them after layers that have too few channels, such as the input layer (granted, that's what Figure 14-19 represents, but it is just for illustration purposes). For this reason, the Xception architecture starts with 2 regular convolutional layers, but then the rest of the architecture uses only separable convolutions (34 in

18 This name can sometimes be ambiguous, since spatially separable convolutions are often called “separable convolutions” as well.

all), plus a few max pooling layers and the usual final layers (a global average pooling layer, and a dense output layer).

You might wonder why Xception is considered a variant of GoogLeNet, since it contains no inception module at all? Well, as we discussed earlier, an Inception module contains convolutional layers with 1×1 filters: these look exclusively for cross-channel patterns. However, the convolution layers that sit on top of them are regular convolutional layers that look both for spatial and cross-channel patterns. So you can think of an Inception module as an intermediate between a regular convolutional layer (which considers spatial patterns and cross-channel patterns jointly) and a separable convolutional layer (which considers them separately). In practice, it seems that separable convolutions generally perform better.



Separable convolutions use less parameters, less memory and less computations than regular convolutional layers, and in general they even perform better, so you should consider using them by default (except after layers with few channels).

The ILSVRC 2016 challenge was won by the CUImage team from the Chinese University of Hong Kong. They used an ensemble of many different techniques, including a sophisticated object-detection system called **GBD-Net**¹⁹, to achieve a top-5 error rate below 3%. Although this result is unquestionably impressive, the complexity of the solution contrasted with the simplicity of ResNets. Moreover, one year later another fairly simple architecture performed even better, as we will see now.

SENet

The winning architecture in the ILSVRC 2017 challenge was the **Squeeze-and-Excitation Network** (SENet)²⁰. This architecture extends existing architectures such as inception networks or ResNets, and boosts their performance. This allowed SENet to win the competition with an astonishing 2.25% top-5 error rate! The extended versions of inception networks and ResNet are called *SE-Inception* and *SE-ResNet* respectively. The boost comes from the fact that a SENet adds a small neural network, called a *SE Block*, to every unit in the original architecture (i.e., every inception module or every residual unit), as shown in **Figure 14-20**.

¹⁹ “Crafting GBD-Net for Object Detection,” X. Zeng et al. (2016).

²⁰ “Squeeze-and-Excitation Networks,” Jie Hu et al. (2017)

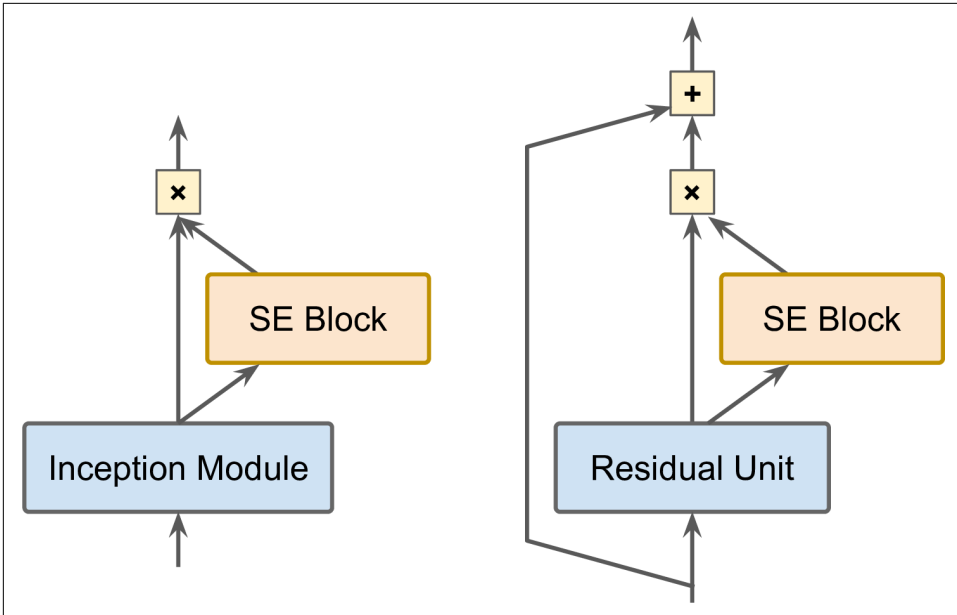

Figure 14-20. SE-Inception Module (left) and SE-ResNet Unit (right)

A SE Block analyzes the output of the unit it is attached to, focusing exclusively on the depth dimension (it does not look for any spatial pattern), and it learns which features are usually most active together. It then uses this information to recalibrate the feature maps, as shown in Figure 14-21. For example, a SE Block may learn that mouths, noses and eyes usually appear together in pictures: if you see a mouth and a nose, you should expect to see eyes as well. So if a SE Block sees a strong activation in the mouth and nose feature maps, but only mild activation in the eye feature map, it will boost the eye feature map (more accurately, it will reduce irrelevant feature maps). If the eyes were somewhat confused with something else, this feature map recalibration will help resolve the ambiguity.

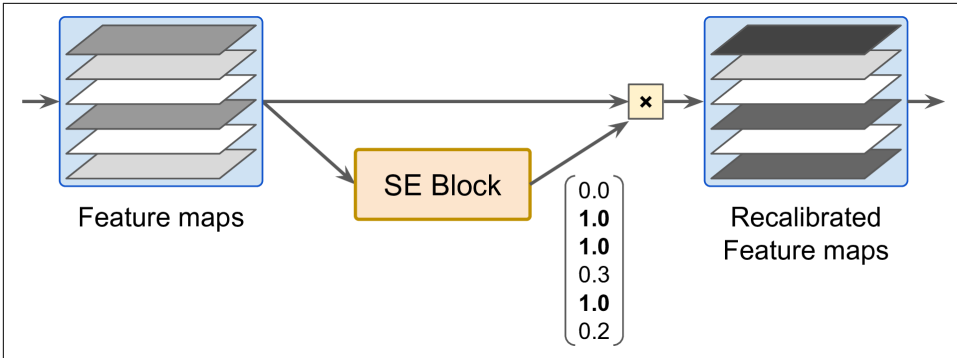

Figure 14-21. An SE Block Performs Feature Map Recalibration

A SE Block is composed of just 3 layers: a global average pooling layer, a hidden dense layer using the ReLU activation function, and a dense output layer using the sigmoid activation function (see Figure 14-22):

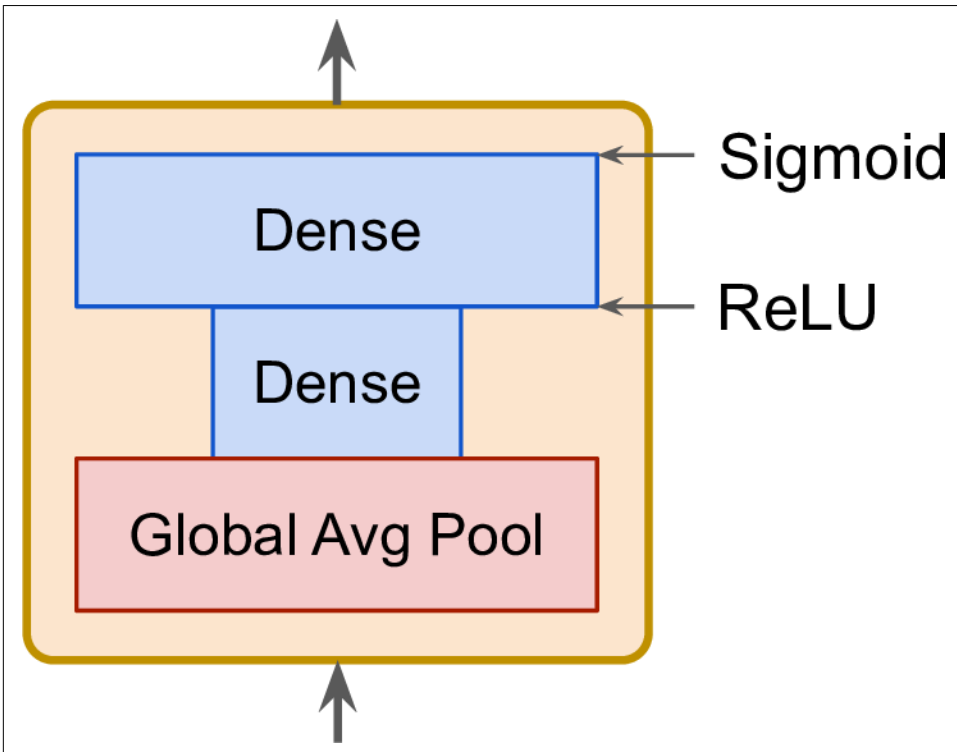

Figure 14-22. SE Block Architecture

As earlier, the global average pooling layer computes the mean activation for each feature map: for example, if its input contains 256 feature maps, it will output 256 numbers representing the overall level of response for each filter. The next layer is where the “squeeze” happens: this layer has much less than 256 neurons, typically 16 times less than the number of feature maps (e.g., 16 neurons), so the 256 numbers get compressed into a small vector (e.g., 16 dimensional). This is a low-dimensional vector representation (i.e., an embedding) of the distribution of feature responses. This bottleneck step forces the SE Block to learn a general representation of the feature combinations (we will see this principle in action again when we discuss autoencoders in ???). Finally, the output layer takes the embedding and outputs a recalibration vector containing one number per feature map (e.g., 256), each between 0 and 1. The feature maps are then multiplied by this recalibration vector, so irrelevant features (with a low recalibration score) get scaled down while relevant features (with a recalibration score close to 1) are left alone.

Implementing a ResNet-34 CNN Using Keras

Most CNN architectures described so far are fairly straightforward to implement (although generally you would load a pretrained network instead, as we will see). To illustrate the process, let’s implement a ResNet-34 from scratch using Keras. First, let’s create a ResidualUnit layer:

```
DefaultConv2D = partial(keras.layers.Conv2D, kernel_size=3, strides=1,
                        padding="SAME", use_bias=False)

class ResidualUnit(keras.layers.Layer):
    def __init__(self, filters, strides=1, activation="relu", **kwargs):
        super().__init__(**kwargs)
        self.activation = keras.activations.get(activation)
        self.main_layers = [
            DefaultConv2D(filters, strides=strides),
            keras.layers.BatchNormalization(),
            self.activation,
            DefaultConv2D(filters),
            keras.layers.BatchNormalization()]
        self.skip_layers = []
        if strides > 1:
            self.skip_layers = [
                DefaultConv2D(filters, kernel_size=1, strides=strides),
                keras.layers.BatchNormalization()]

    def call(self, inputs):
        Z = inputs
        for layer in self.main_layers:
            Z = layer(Z)
        skip_Z = inputs
        for layer in self.skip_layers:
```

```

        skip_Z = layer(skip_Z)
    return self.activation(Z + skip_Z)

```

As you can see, this code matches [Figure 14-18](#) pretty closely. In the constructor, we create all the layers we will need: the main layers are the ones on the right side of the diagram, and the skip layers are the ones on the left (only needed if the stride is greater than 1). Then in the `call()` method, we simply make the inputs go through the main layers, and the skip layers (if any), then we add both outputs and we apply the activation function.

Next, we can build the ResNet-34 simply using a `Sequential` model, since it is really just a long sequence of layers (we can treat each residual unit as a single layer now that we have the `ResidualUnit` class):

```

model = keras.models.Sequential()
model.add(DefaultConv2D(64, kernel_size=7, strides=2,
                        input_shape=[224, 224, 3]))
model.add(keras.layers.BatchNormalization())
model.add(keras.layers.Activation("relu"))
model.add(keras.layers.MaxPool2D(pool_size=3, strides=2, padding="SAME"))
prev_filters = 64
for filters in [64] * 3 + [128] * 4 + [256] * 6 + [512] * 3:
    strides = 1 if filters == prev_filters else 2
    model.add(ResidualUnit(filters, strides=strides))
    prev_filters = filters
model.add(keras.layers.GlobalAvgPool2D())
model.add(keras.layers.Flatten())
model.add(keras.layers.Dense(10, activation="softmax"))

```

The only slightly tricky part in this code is the loop that adds the `ResidualUnit` layers to the model: as explained earlier, the first 3 RUs have 64 filters, then the next 4 RUs have 128 filters, and so on. We then set the strides to 1 when the number of filters is the same as in the previous RU, or else we set it to 2. Then we add the `ResidualUnit`, and finally we update `prev_filters`.

It is quite amazing that in less than 40 lines of code, we can build the model that won the ILSVRC 2015 challenge! It demonstrates both the elegance of the ResNet model, and the expressiveness of the Keras API. Implementing the other CNN architectures is not much harder. However, Keras comes with several of these architectures built in, so why not use them instead?

Using Pretrained Models From Keras

In general, you won't have to implement standard models like GoogLeNet or ResNet manually, since pretrained networks are readily available with a single line of code, in the `keras.applications` package. For example:

```

model = keras.applications.resnet50.ResNet50(weights="imagenet")

```

That's all! This will create a ResNet-50 model and download weights pretrained on the ImageNet dataset. To use it, you first need to ensure that the images have the right size. A ResNet-50 model expects 224×224 images (other models may expect other sizes, such as 299×299), so let's use TensorFlow's `tf.image.resize()` function to resize the images we loaded earlier:

```
images_resized = tf.image.resize(images, [224, 224])
```



The `tf.image.resize()` will not preserve the aspect ratio. If this is a problem, you can try cropping the images to the appropriate aspect ratio before resizing. Both operations can be done in one shot with `tf.image.crop_and_resize()`.

The pretrained models assume that the images are preprocessed in a specific way. In some cases they may expect the inputs to be scaled from 0 to 1, or -1 to 1, and so on. Each model provides a `preprocess_input()` function that you can use to preprocess your images. These functions assume that the pixel values range from 0 to 255, so we must multiply them by 255 (since earlier we scaled them to the 0–1 range):

```
inputs = keras.applications.resnet50.preprocess_input(images_resized * 255)
```

Now we can use the pretrained model to make predictions:

```
Y_proba = model.predict(inputs)
```

As usual, the output `Y_proba` is a matrix with one row per image and one column per class (in this case, there are 1,000 classes). If you want to display the top K predictions, including the class name and the estimated probability of each predicted class, you can use the `decode_predictions()` function. For each image, it returns an array containing the top K predictions, where each prediction is represented as an array containing the class identifier²¹, its name and the corresponding confidence score:

```
top_k = keras.applications.resnet50.decode_predictions(Y_proba, top=3)
for image_index in range(len(images)):
    print("Image #{}".format(image_index))
    for class_id, name, y_proba in top_k[image_index]:
        print(" {} - {:12s} {:.2f}%".format(class_id, name, y_proba * 100))
    print()
```

The output looks like this:

```
Image #0
n03877845 - palace      42.87%
n02825657 - bell_cote  40.57%
n03781244 - monastery  14.56%
```

²¹ In the ImageNet dataset, each image is associated to a word in the [WordNet dataset](#): the class ID is just a WordNet ID.

```
Image #1
n04522168 - vase      46.83%
n07930864 - cup       7.78%
n11939491 - daisy    4.87%
```

The correct classes (monastery and daisy) appear in the top 3 results for both images. That's pretty good considering that the model had to choose among 1,000 classes.

As you can see, it is very easy to create a pretty good image classifier using a pre-trained model. Other vision models are available in `keras.applications`, including several ResNet variants, GoogLeNet variants like InceptionV3 and Xception, VGGNet variants, MobileNet and MobileNetV2 (lightweight models for use in mobile applications), and more.

But what if you want to use an image classifier for classes of images that are not part of ImageNet? In that case, you may still benefit from the pretrained models to perform transfer learning.

Pretrained Models for Transfer Learning

If you want to build an image classifier, but you do not have enough training data, then it is often a good idea to reuse the lower layers of a pretrained model, as we discussed in [Chapter 11](#). For example, let's train a model to classify pictures of flowers, reusing a pretrained Xception model. First, let's load the dataset using TensorFlow Datasets (see [Chapter 13](#)):

```
import tensorflow_datasets as tfds

dataset, info = tfds.load("tf_flowers", as_supervised=True, with_info=True)
dataset_size = info.splits["train"].num_examples # 3670
class_names = info.features["label"].names # ["dandelion", "daisy", ...]
n_classes = info.features["label"].num_classes # 5
```

Note that you can get information about the dataset by setting `with_info=True`. Here, we get the dataset size and the names of the classes. Unfortunately, there is only a "train" dataset, no test set or validation set, so we need to split the training set. The TF Datasets project provides an API for this. For example, let's take the first 10% of the dataset for testing, the next 15% for validation, and the remaining 75% for training:

```
test_split, valid_split, train_split = tfds.Split.TRAIN.subsplit([10, 15, 75])

test_set = tfds.load("tf_flowers", split=test_split, as_supervised=True)
valid_set = tfds.load("tf_flowers", split=valid_split, as_supervised=True)
train_set = tfds.load("tf_flowers", split=train_split, as_supervised=True)
```

Next we must preprocess the images. The CNN expects 224×224 images, so we need to resize them. We also need to run the image through Xception's `preprocess_input()` function:

```
def preprocess(image, label):
    resized_image = tf.image.resize(image, [224, 224])
    final_image = keras.applications.xception.preprocess_input(resized_image)
    return final_image, label
```

Let's apply this preprocessing function to all 3 datasets, and let's also shuffle & repeat the training set, and add batching & prefetching to all datasets:

```
batch_size = 32
train_set = train_set.shuffle(1000).repeat()
train_set = train_set.map(preprocess).batch(batch_size).prefetch(1)
valid_set = valid_set.map(preprocess).batch(batch_size).prefetch(1)
test_set = test_set.map(preprocess).batch(batch_size).prefetch(1)
```

If you want to perform some data augmentation, you can just change the preprocessing function for the training set, adding some random transformations to the training images. For example, use `tf.image.random_crop()` to randomly crop the images, use `tf.image.random_flip_left_right()` to randomly flip the images horizontally, and so on (see the notebook for an example).

Next let's load an Xception model, pretrained on ImageNet. We exclude the top of the network (by setting `include_top=False`): this excludes the global average pooling layer and the dense output layer. We then add our own global average pooling layer, based on the output of the base model, followed by a dense output layer with 1 unit per class, using the softmax activation function. Finally, we create the Keras Model:

```
base_model = keras.applications.xception.Xception(weights="imagenet",
                                                  include_top=False)
avg = keras.layers.GlobalAveragePooling2D()(base_model.output)
output = keras.layers.Dense(n_classes, activation="softmax")(avg)
model = keras.models.Model(inputs=base_model.input, outputs=output)
```

As explained in [Chapter 11](#), it's usually a good idea to freeze the weights of the pretrained layers, at least at the beginning of training:

```
for layer in base_model.layers:
    layer.trainable = False
```



Since our model uses the base model's layers directly, rather than the `base_model` object itself, setting `base_model.trainable=False` would have no effect.

Finally, we can compile the model and start training:

```
optimizer = keras.optimizers.SGD(lr=0.2, momentum=0.9, decay=0.01)
model.compile(loss="sparse_categorical_crossentropy", optimizer=optimizer,
              metrics=["accuracy"])
history = model.fit(train_set,
                    steps_per_epoch=int(0.75 * dataset_size / batch_size),
                    validation_data=valid_set,
                    validation_steps=int(0.15 * dataset_size / batch_size),
                    epochs=5)
```



This will be very slow, unless you have a GPU. If you do not, then you should run this chapter's notebook in Colab, using a GPU runtime (it's free!). See the instructions at <https://github.com/ageron/handson-ml2>.

After training the model for a few epochs, its validation accuracy should reach about 75-80%, and stop making much progress. This means that the top layers are now pretty well trained, so we are ready to unfreeze all layers (or you could try unfreezing just the top ones), and continue training (don't forget to compile the model when you freeze or unfreeze layers). This time we use a much lower learning rate to avoid damaging the pretrained weights:

```
for layer in base_model.layers:
    layer.trainable = True

optimizer = keras.optimizers.SGD(lr=0.01, momentum=0.9, decay=0.001)
model.compile(...)
history = model.fit(...)
```

It will take a while, but this model should reach around 95% accuracy on the test set. With that, you can start training amazing image classifiers! But there's more to computer vision than just classification. For example, what if you also want to know *where* the flower is in the picture? Let's look at this now.

Classification and Localization

Localizing an object in a picture can be expressed as a regression task, as discussed in [Chapter 10](#): to predict a bounding box around the object, a common approach is to predict the horizontal and vertical coordinates of the object's center, as well as its height and width. This means we have 4 numbers to predict. It does not require much change to the model, we just need to add a second dense output layer with 4 units (typically on top of the global average pooling layer), and it can be trained using the MSE loss:

```
base_model = keras.applications.xception.Xception(weights="imagenet",
                                                  include_top=False)
avg = keras.layers.GlobalAveragePooling2D()(base_model.output)
class_output = keras.layers.Dense(n_classes, activation="softmax")(avg)
```

```

loc_output = keras.layers.Dense(4)(avg)
model = keras.models.Model(inputs=base_model.input,
                           outputs=[class_output, loc_output])
model.compile(loss=["sparse_categorical_crossentropy", "mse"],
              loss_weights=[0.8, 0.2], # depends on what you care most about
              optimizer=optimizer, metrics=["accuracy"])

```

But now we have a problem: the flowers dataset does not have bounding boxes around the flowers. So we need to add them ourselves. This is often one of the hardest and most costly part of a Machine Learning project: getting the labels. It's a good idea to spend time looking for the right tools. To annotate images with bounding boxes, you may want to use an open source image labeling tool like VGG Image Annotator, LabelImg, OpenLabeler or ImgLab, or perhaps a commercial tool like LabelBox or Supervisely. You may also want to consider crowdsourcing platforms such as Amazon Mechanical Turk or CrowdFlower if you have a very large number of images to annotate. However, it is quite a lot of work to setup a crowdsourcing platform, prepare the form to be sent to the workers, to supervise them and ensure the quality of the bounding boxes they produce is good, so make sure it is worth the effort: if there are just a few thousand images to label, and you don't plan to do this frequently, it may be preferable to do it yourself. Adriana Kovashka et al. wrote a very practical [paper](#)²² about crowdsourcing in Computer Vision, I recommend you check it out, even if you do not plan to use crowdsourcing.

So let's suppose you obtained the bounding boxes for every image in the flowers dataset (for now we will assume there is a single bounding box per image), you then need to create a dataset whose items will be batches of preprocessed images along with their class labels and their bounding boxes. Each item should be a tuple of the form: (images, (class_labels, bounding_boxes)). Then you are ready to train your model!



The bounding boxes should be normalized so that the horizontal and vertical coordinates, as well as the height and width all range from 0 to 1. Also, it is common to predict the square root of the height and width rather than the height and width directly: this way, a 10 pixel error for a large bounding box will not be penalized as much as a 10 pixel error for a small bounding box.

The MSE often works fairly well as a cost function to train the model, but it is not a great metric to evaluate how well the model can predict bounding boxes. The most common metric for this is the Intersection over Union (IoU): it is the area of overlap between the predicted bounding box and the target bounding box, divided by the

²² “Crowdsourcing in Computer Vision,” A. Kovashka et al. (2016).

area of their union (see [Figure 14-23](#)). In `tf.keras`, it is implemented by the `tf.keras.metrics.MeanIoU` class.

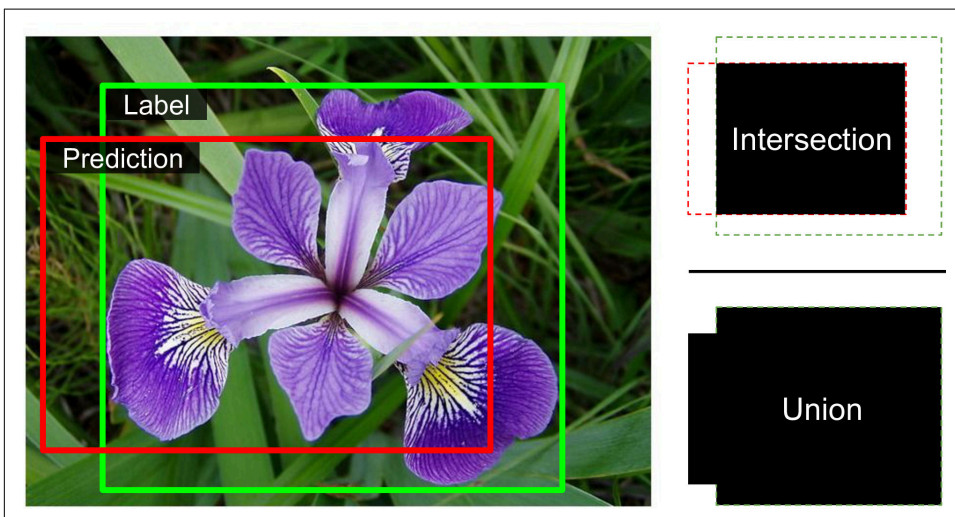

Figure 14-23. Intersection over Union (IoU) Metric for Bounding Boxes

Classifying and localizing a single object is nice, but what if the images contain multiple objects (as is often the case in the flowers dataset)?

Object Detection

The task of classifying and localizing multiple objects in an image is called *object detection*. Until a few years ago, a common approach was to take a CNN that was trained to classify and locate a single object, then slide it across the image, as shown in [Figure 14-24](#). In this example, the image was chopped into a 6×8 grid, and we show a CNN (the thick black rectangle) sliding across all 3×3 regions. When the CNN was looking at the top left of the image, it detected part of the left-most rose, and then it detected that same rose again when it was first shifted one step to the right. At the next step, it started detecting part of the top-most rose, and then it detected it again once it was shifted one more step to the right. You would then continue to slide the CNN through the whole image, looking at all 3×3 regions. Moreover, since objects can have varying sizes, you would also slide the CNN across regions of different sizes. For example, once you are done with the 3×3 regions, you might want to slide the CNN across all 4×4 regions as well.

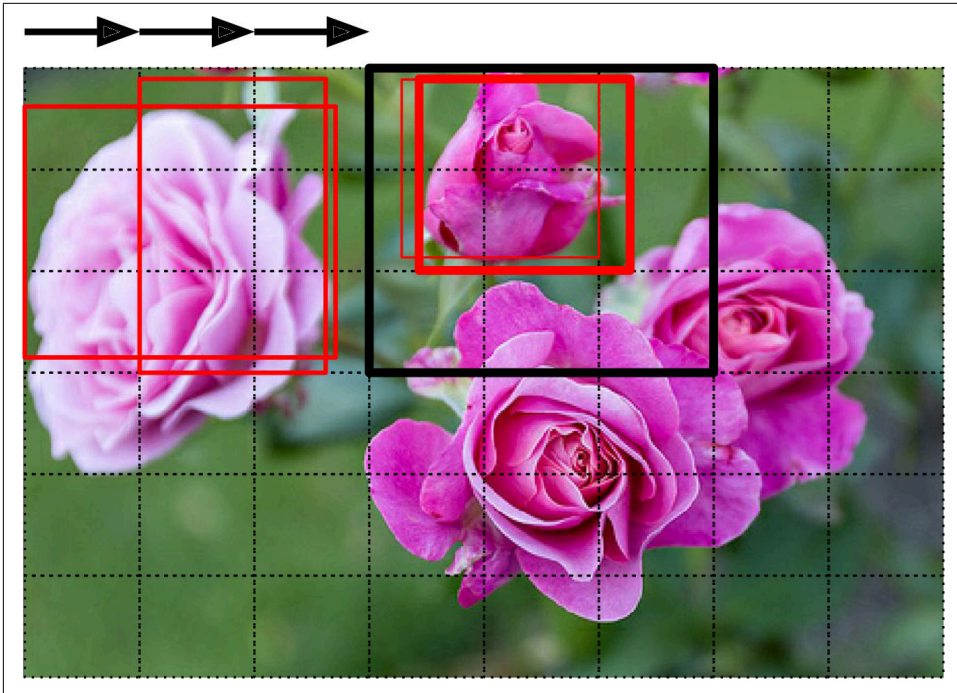

Figure 14-24. Detecting Multiple Objects by Sliding a CNN Across the Image

This technique is fairly straightforward, but as you can see it will detect the same object multiple times, at slightly different positions. Some post-processing will then be needed to get rid of all the unnecessary bounding boxes. A common approach for this is called *non-max suppression*:

- First, you need to add an extra *objectness* output to your CNN, to estimate the probability that a flower is indeed present in the image (alternatively, you could add a “no-flower” class, but this usually does not work as well). It must use the sigmoid activation function and you can train it using the “binary_crossentropy” loss. Then just get rid of all the bounding boxes for which the objectness score is below some threshold: this will drop all the bounding boxes that don’t actually contain a flower.
- Second, find the bounding box with the highest objectness score, and get rid of all the other bounding boxes that overlap a lot with it (e.g., with an IoU greater than 60%). For example, in Figure 14-24, the bounding box with the max objectness score is the thick bounding box over the top-most rose (the objectness score is represented by the thickness of the bounding boxes). The other bounding box over that same rose overlaps a lot with the max bounding box, so we will get rid of it.

- Third, repeat step two until there are no more bounding boxes to get rid of.

This simple approach to object detection works pretty well, but it requires running the CNN many times, so it is quite slow. Fortunately, there is a much faster way to slide a CNN across an image: using a *Fully Convolutional Network*.

Fully Convolutional Networks (FCNs)

The idea of FCNs was first introduced in a [2015 paper](#)²³ by Jonathan Long et al., for semantic segmentation (the task of classifying every pixel in an image according to the class of the object it belongs to). They pointed out that you could replace the dense layers at the top of a CNN by convolutional layers. To understand this, let's look at an example: suppose a dense layer with 200 neurons sits on top of a convolutional layer that outputs 100 feature maps, each of size 7×7 (this is the feature map size, not the kernel size). Each neuron will compute a weighted sum of all $100 \times 7 \times 7$ activations from the convolutional layer (plus a bias term). Now let's see what happens if we replace the dense layer with a convolution layer using 200 filters, each 7×7 , and with VALID padding. This layer will output 200 feature maps, each 1×1 (since the kernel is exactly the size of the input feature maps and we are using VALID padding). In other words, it will output 200 numbers, just like the dense layer did, and if you look closely at the computations performed by a convolutional layer, you will notice that these numbers will be precisely the same as the dense layer produced. The only difference is that the dense layer's output was a tensor of shape [batch size, 200] while the convolutional layer will output a tensor of shape [batch size, 1, 1, 200].



To convert a dense layer to a convolutional layer, the number of filters in the convolutional layer must be equal to the number of units in the dense layer, the filter size must be equal to the size of the input feature maps, and you must use VALID padding. The stride may be set to 1 or more, as we will see shortly.

Why is this important? Well, while a dense layer expects a specific input size (since it has one weight per input feature), a convolutional layer will happily process images of any size²⁴ (however, it does expect its inputs to have a specific number of channels, since each kernel contains a different set of weights for each input channel). Since an FCN contains only convolutional layers (and pooling layers, which have the same property), it can be trained and executed on images of any size!

²³ "Fully Convolutional Networks for Semantic Segmentation," J. Long, E. Shelhamer, T. Darrell (2015).

²⁴ There is one small exception: a convolutional layer using VALID padding will complain if the input size is smaller than the kernel size.

For example, suppose we already trained a CNN for flower classification and localization. It was trained on 224×224 images and it outputs 10 numbers: outputs 0 to 4 are sent through the softmax activation function, and this gives the class probabilities (one per class); output 5 is sent through the logistic activation function, and this gives the objectness score; outputs 6 to 9 do not use any activation function, and they represent the bounding box's center coordinates, and its height and width. We can now convert its dense layers to convolutional layers. In fact, we don't even need to retrain it, we can just copy the weights from the dense layers to the convolutional layers! Alternatively, we could have converted the CNN into an FCN before training.

Now suppose the last convolutional layer before the output layer (also called the bottleneck layer) outputs 7×7 feature maps when the network is fed a 224×224 image (see the left side of [Figure 14-25](#)). If we feed the FCN a 448×448 image (see the right side of [Figure 14-25](#)), the bottleneck layer will now output 14×14 feature maps.²⁵ Since the dense output layer was replaced by a convolutional layer using 10 filters of size 7×7 , VALID padding and stride 1, the output will be composed of 10 feature maps, each of size 8×8 (since $14 - 7 + 1 = 8$). In other words, the FCN will process the whole image only once and it will output an 8×8 grid where each cell contains 10 numbers (5 class probabilities, 1 objectness score and 4 bounding box coordinates). It's exactly like taking the original CNN and sliding it across the image using 8 steps per row and 8 steps per column: to visualize this, imagine chopping the original image into a 14×14 grid, then sliding a 7×7 window across this grid: there will be $8 \times 8 = 64$ possible locations for the window, hence 8×8 predictions. However, the FCN approach is *much* more efficient, since the network only looks at the image once. In fact, *You Only Look Once* (YOLO) is the name of a very popular object detection architecture!

²⁵ This assumes we used only SAME padding in the network: indeed, VALID padding would reduce the size of the feature maps. Moreover, 448 can be neatly divided by 2 several times until we reach 7, without any rounding error. If any layer uses a different stride than 1 or 2, then there may be some rounding error, so again the feature maps may end up being smaller.

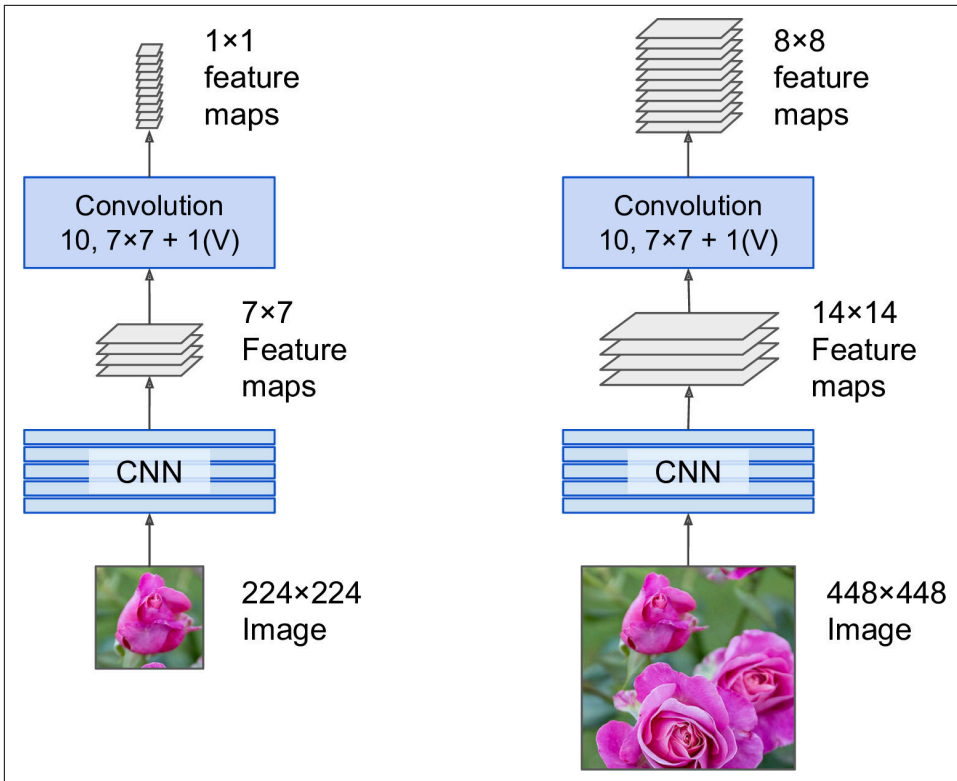

Figure 14-25. A Fully Convolutional Network Processing a Small Image (left) and a Large One (right)

You Only Look Once (YOLO)

YOLO is an extremely fast and accurate object detection architecture proposed by Joseph Redmon et al. in a [2015 paper](#)²⁶, and subsequently improved in [2016](#)²⁷ (YOLOv2) and in [2018](#)²⁸ (YOLOv3). It is so fast that it can run in realtime on a video (check out this nice [demo](#)).

YOLOv3's architecture is quite similar to the one we just discussed, but with a few important differences:

26 "You Only Look Once: Unified, Real-Time Object Detection," J. Redmon, S. Divvala, R. Girshick, A. Farhadi (2015).

27 "YOLO9000: Better, Faster, Stronger," J. Redmon, A. Farhadi (2016).

28 "YOLOv3: An Incremental Improvement," J. Redmon, A. Farhadi (2018).

- First, it outputs 5 bounding boxes for each grid cell (instead of just 1), and each bounding box comes with an objectness score. It also outputs 20 class probabilities per grid cell, as it was trained on the PASCAL VOC dataset, which contains 20 classes. That's a total of 45 numbers per grid cell (5 * 4 bounding box coordinates, plus 5 objectness scores, plus 20 class probabilities).
- Second, instead of predicting the absolute coordinates of the bounding box centers, YOLOv3 predicts an offset relative to the coordinates of the grid cell, where (0, 0) means the top left of that cell, and (1, 1) means the bottom right. For each grid cell, YOLOv3 is trained to predict only bounding boxes whose center lies in that cell (but the bounding box itself generally extends well beyond the grid cell). YOLOv3 applies the logistic activation function to the bounding box coordinates to ensure they remain in the 0 to 1 range.
- Third, before training the neural net, YOLOv3 finds 5 representative bounding box dimensions, called *anchor boxes* (or *bounding box priors*): it does this by applying the K-Means algorithm (see ???) to the height and width of the training set bounding boxes. For example, if the training images contain many pedestrians, then one of the anchor boxes will likely have the dimensions of a typical pedestrian. Then when the neural net predicts 5 bounding boxes per grid cell, it actually predicts how much to rescale each of the anchor boxes. For example, suppose one anchor box is 100 pixels tall and 50 pixels wide, and the network predicts, say, a vertical rescaling factor of 1.5 and a horizontal rescaling of 0.9 (for one of the grid cells), this will result in a predicted bounding box of size 150×45 pixels. To be more precise, for each grid cell and each anchor box, the network predicts the log of the vertical and horizontal rescaling factors. Having these priors makes the network more likely to predict bounding boxes of the appropriate dimensions, and it also speeds up training since it will more quickly learn what reasonable bounding boxes look like.
- Fourth, the network is trained using images of different scales: every few batches during training, the network randomly chooses a new image dimension (from 330×330 to 608×608 pixels). This allows the network to learn to detect objects at different scales. Moreover, it makes it possible to use YOLOv3 at different scales: the smaller scale will be less accurate but faster than the larger scale, so you can choose the right tradeoff for your use case.

There are a few more innovations you might be interested in, such as the use of skip connections to recover some of the spatial resolution that is lost in the CNN (we will discuss this shortly when we look at semantic segmentation). Moreover, in the 2016 paper, the authors introduce the YOLO9000 model that uses hierarchical classification: the model predicts a probability for each node in a visual hierarchy called *Word-Tree*. This makes it possible for the network to predict with high confidence that an image represents, say, a dog, even though it is unsure what specific type of dog it is.

So I encourage you to go ahead and read all three papers: they are quite pleasant to read, and it is an excellent example of how Deep Learning systems can be incrementally improved.

Mean Average Precision (mAP)

A very common metric used in object detection tasks is the *mean Average Precision* (mAP). “Mean Average” sounds a bit redundant, doesn’t it? To understand this metric, let’s go back to two classification metrics we discussed in [Chapter 3](#): precision and recall. Remember the tradeoff: the higher the recall, the lower the precision. You can visualize this in a Precision/Recall curve (see [Figure 3-5](#)). To summarize this curve into a single number, we could compute its Area Under the Curve (AUC). But note that the Precision/Recall curve may contain a few sections where precision actually goes up when recall increases, especially at low recall values (you can see this at the top left of [Figure 3-5](#)). This is one of the motivations for the mAP metric.

Suppose the classifier has a 90% precision at 10% recall, but a 96% precision at 20% recall: there’s really no tradeoff here: it simply makes more sense to use the classifier at 20% recall rather than at 10% recall, as you will get both higher recall and higher precision. So instead of looking at the precision *at* 10% recall, we should really be looking at the *maximum* precision that the classifier can offer with *at least* 10% recall. It would be 96%, not 90%. So one way to get a fair idea of the model’s performance is to compute the maximum precision you can get with at least 0% recall, then 10% recall, 20%, and so on up to 100%, and then calculate the mean of these maximum precisions. This is called the *Average Precision* (AP) metric. Now when there are more than 2 classes, we can compute the AP for each class, and then compute the mean AP (mAP). That’s it!

However, in an object detection systems, there is an additional level of complexity: what if the system detected the correct class, but at the wrong location (i.e., the bounding box is completely off)? Surely we should not count this as a positive prediction. So one approach is to define an IOU threshold: for example, we may consider that a prediction is correct only if the IOU is greater than, say, 0.5, and the predicted class is correct. The corresponding mAP is generally noted mAP@0.5 (or mAP@50%, or sometimes just AP₅₀). In some competitions (such as the Pascal VOC challenge), this is what is done. In others (such as the COCO competition), the mAP is computed for different IOU thresholds (0.50, 0.55, 0.60, ..., 0.95), and the final metric is the mean of all these mAPs (noted AP@[.50:.95] or AP@[.50:0.05:.95]). Yes, that’s a mean mean average.

Several YOLO implementations built using TensorFlow are available on github, some with pretrained weights. At the time of writing, they are based on TensorFlow 1, but by the time you read this, TF 2 implementations will certainly be available. Moreover, other object detection models are available in the TensorFlow Models project, many

with pretrained weights, and some have even been ported to TF Hub, making them extremely easy to use, such as **SSD**²⁹ and **Faster-RCNN**.³⁰, which are both quite popular. SSD is also a “single shot” detection model, quite similar to YOLO, while Faster RCNN is more complex: the image first goes through a CNN, and the output is passed to a Region Proposal Network (RPN) which proposes bounding boxes that are most likely to contain an object, and a classifier is run for each bounding box, based on the cropped output of the CNN.

The choice of detection system depends on many factors: speed, accuracy, available pretrained models, training time, complexity, etc. The papers contain tables of metrics, but there is quite a lot of variability in the testing environments, and the technologies evolve so fast that it is difficult to make a fair comparison that will be useful for most people and remain valid for more than a few months.

Great! So we can locate objects by drawing bounding boxes around them. But perhaps you might want to be a bit more precise. Let's see how to go down to the pixel level.

Semantic Segmentation

In *semantic segmentation*, each pixel is classified according to the class of the object it belongs to (e.g., road, car, pedestrian, building, etc.), as shown in **Figure 14-26**. Note that different objects of the same class are *not* distinguished. For example, all the bicycles on the right side of the segmented image end up as one big lump of pixels. The main difficulty in this task is that when images go through a regular CNN, they gradually lose their spatial resolution (due to the layers with strides greater than 1): so a regular CNN may end up knowing that there's a person in the image, somewhere in the bottom left of the image, but it will not be much more precise than that.

29 “SSD: Single Shot MultiBox Detector,” Wei Liu et al. (2015).

30 “Faster R-CNN: Towards Real-Time Object Detection with Region Proposal Networks,” Shaoqing Ren et al. (2015).



Figure 14-26. Semantic segmentation

Just like for object detection, there are many different approaches to tackle this problem, some quite complex. However, a fairly simple solution was proposed in the 2015 paper by Jonathan Long et al. we discussed earlier. They start by taking a pretrained CNN and turning into an FCN, as discussed earlier. The CNN applies a stride of 32 to the input image overall (i.e., if you add up all the strides greater than 1), meaning the last layer outputs feature maps that are 32 times smaller than the input image. This is clearly too coarse, so they add a single *upsampling layer* that multiplies the resolution by 32. There are several solutions available for upsampling (increasing the size of an image), such as bilinear interpolation, but it only works reasonably well up to $\times 4$ or $\times 8$. Instead, they used a *transposed convolutional layer*:³¹ it is equivalent to first stretching the image by inserting empty rows and columns (full of zeros), then performing a regular convolution (see Figure 14-27). Alternatively, some people prefer to think of it as a regular convolutional layer that uses fractional strides (e.g., $1/2$ in Figure 14-27). The *transposed convolutional layer* can be initialized to perform something close to linear interpolation, but since it is a trainable layer, it will learn to do better during training.

³¹ This type of layer is sometimes referred to as a *deconvolution layer*, but it does *not* perform what mathematicians call a deconvolution, so this name should be avoided.

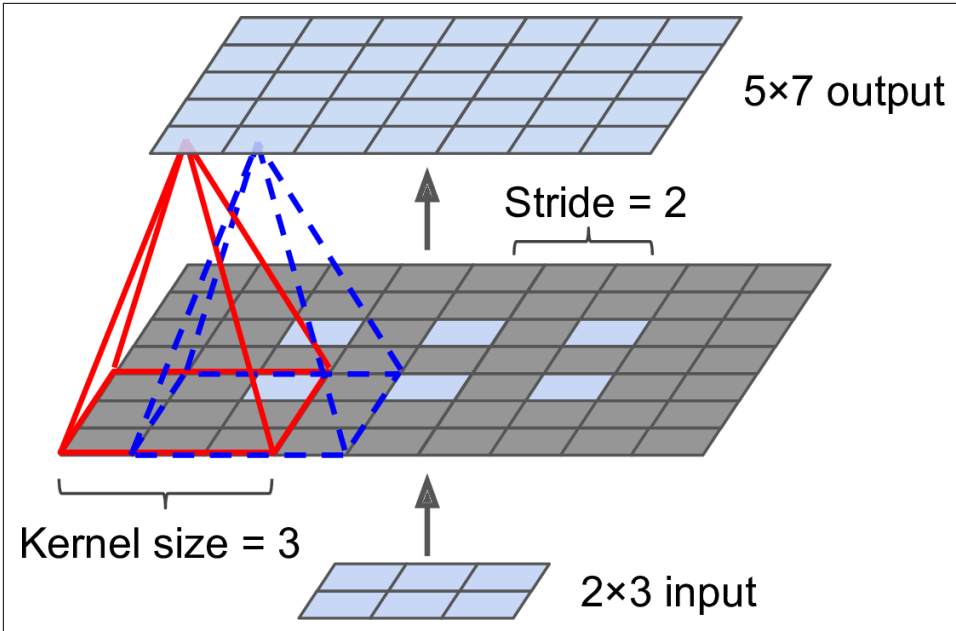

Figure 14-27. Upsampling Using a Transpose Convolutional Layer



In a transposed convolution layer, the stride defines how much the input will be stretched, not the size of the filter steps, so the larger the stride, the larger the output (unlike for convolutional layers or pooling layers).

TensorFlow Convolution Operations

TensorFlow also offers a few other kinds of convolutional layers:

- `keras.layers.Conv1D` creates a convolutional layer for 1D inputs, such as time series or text (sequences of letters or words), as we will see in ???.
- `keras.layers.Conv3D` creates a convolutional layer for 3D inputs, such as 3D PET scan.
- Setting the `dilation_rate` hyperparameter of any convolutional layer to a value of 2 or more creates an *à-trous convolutional layer* (“à trous” is French for “with holes”). This is equivalent to using a regular convolutional layer with a filter dilated by inserting rows and columns of zeros (i.e., holes). For example, a 1×3 filter equal to `[[1,2,3]]` may be dilated with a *dilation rate* of 4, resulting in a *dilated filter* `[[1, 0, 0, 0, 2, 0, 0, 0, 3]]`. This allows the convolutional layer to

have a larger receptive field at no computational price and using no extra parameters.

- `tf.nn.depthwise_conv2d()` can be used to create a *depthwise convolutional layer* (but you need to create the variables yourself). It applies every filter to every individual input channel independently. Thus, if there are f_n filters and f_{in} input channels, then this will output $f_n \times f_{in}$ feature maps.

This solution is okay, but still too imprecise. To do better, the authors added skip connections from lower layers: for example, they upsampled the output image by a factor of 2 (instead of 32), and they added the output of a lower layer that had this double resolution. Then they upsampled the result by a factor of 16, leading to a total upsampling factor of 32 (see Figure 14-28). This recovered some of the spatial resolution that was lost in earlier pooling layers. In their best architecture, they used a second similar skip connection to recover even finer details from an even lower layer: in short, the output of the original CNN goes through the following extra steps: upscale $\times 2$, add the output of a lower layer (of the appropriate scale), upscale $\times 2$, add the output of an even lower layer, and finally upscale $\times 8$. It is even possible to scale up beyond the size of the original image: this can be used to increase the resolution of an image, which is a technique called *super-resolution*.

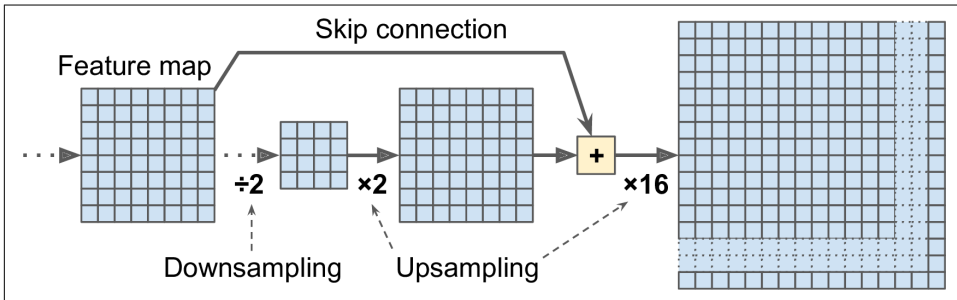

Figure 14-28. Skip layers recover some spatial resolution from lower layers

Once again, many github repositories provide TensorFlow implementations of semantic segmentation (TensorFlow 1 for now), and you will even find a pretrained *instance segmentation* model in the TensorFlow Models project. Instance segmentation is similar to semantic segmentation, but instead of merging all objects of the same class into one big lump, each object is distinguished from the others (e.g., it identifies each individual bicycle). At the present, they provide multiple implementations of the *Mask R-CNN* architecture, which was proposed in a 2017 paper: it extends the Faster R-CNN model by additionally producing a pixel-mask for each bounding box. So not only do you get a bounding box around each object, with a set of estimated class probabilities, you also get a pixel mask that locates pixels in the bounding box that belong to the object.

As you can see, the field of Deep Computer Vision is vast and moving fast, with all sorts of architectures popping out every year, all based on Convolutional Neural Networks. The progress made in just a few years has been astounding, and researchers are now focusing on harder and harder problems, such as *adversarial learning* (which attempts to make the network more resistant to images designed to fool it), explainability (understanding why the network makes a specific classification), realistic *image generation* (which we will come back to in ???), *single-shot learning* (a system that can recognize an object after it has seen it just once), and much more. Some even explore completely novel architectures, such as Geoffrey Hinton's *capsule networks*³² (I presented them in a couple [videos](#), with the corresponding code in a notebook). Now on to the next chapter, where we will look at how to process sequential data such as time series using Recurrent Neural Networks and Convolutional Neural Networks.

Exercises

1. What are the advantages of a CNN over a fully connected DNN for image classification?
2. Consider a CNN composed of three convolutional layers, each with 3×3 kernels, a stride of 2, and SAME padding. The lowest layer outputs 100 feature maps, the middle one outputs 200, and the top one outputs 400. The input images are RGB images of 200×300 pixels. What is the total number of parameters in the CNN? If we are using 32-bit floats, at least how much RAM will this network require when making a prediction for a single instance? What about when training on a mini-batch of 50 images?
3. If your GPU runs out of memory while training a CNN, what are five things you could try to solve the problem?
4. Why would you want to add a max pooling layer rather than a convolutional layer with the same stride?
5. When would you want to add a *local response normalization* layer?
6. Can you name the main innovations in AlexNet, compared to LeNet-5? What about the main innovations in GoogLeNet, ResNet, SENet and Xception?
7. What is a Fully Convolutional Network? How can you convert a dense layer into a convolutional layer?
8. What is the main technical difficulty of semantic segmentation?
9. Build your own CNN from scratch and try to achieve the highest possible accuracy on MNIST.

³² "Matrix Capsules with EM Routing," G. Hinton, S. Sabour, N. Frosst (2018).

10. Use transfer learning for large image classification.
 - a. Create a training set containing at least 100 images per class. For example, you could classify your own pictures based on the location (beach, mountain, city, etc.), or alternatively you can just use an existing dataset (e.g., from TensorFlow Datasets).
 - b. Split it into a training set, a validation set and a test set.
 - c. Build the input pipeline, including the appropriate preprocessing operations, and optionally add data augmentation.
 - d. Fine-tune a pretrained model on this dataset.
11. Go through TensorFlow's [DeepDream tutorial](#). It is a fun way to familiarize yourself with various ways of visualizing the patterns learned by a CNN, and to generate art using Deep Learning.

Solutions to these exercises are available in [???](#).

About the Author

Aurélien Géron is a Machine Learning consultant. A former Googler, he led the YouTube video classification team from 2013 to 2016. He was also a founder and CTO of Wifirst from 2002 to 2012, a leading Wireless ISP in France; and a founder and CTO of Polyconseil in 2001, the firm that now manages the electric car sharing service Autolib’.

Before this he worked as an engineer in a variety of domains: finance (JP Morgan and Société Générale), defense (Canada’s DOD), and healthcare (blood transfusion). He published a few technical books (on C++, WiFi, and internet architectures), and was a Computer Science lecturer in a French engineering school.

A few fun facts: he taught his three children to count in binary with their fingers (up to 1023), he studied microbiology and evolutionary genetics before going into software engineering, and his parachute didn’t open on the second jump.

Colophon

The animal on the cover of *Hands-On Machine Learning with Scikit-Learn and TensorFlow* is the fire salamander (*Salamandra salamandra*), an amphibian found across most of Europe. Its black, glossy skin features large yellow spots on the head and back, signaling the presence of alkaloid toxins. This is a possible source of this amphibian’s common name: contact with these toxins (which they can also spray short distances) causes convulsions and hyperventilation. Either the painful poisons or the moistness of the salamander’s skin (or both) led to a misguided belief that these creatures not only could survive being placed in fire but could extinguish it as well.

Fire salamanders live in shaded forests, hiding in moist crevices and under logs near the pools or other freshwater bodies that facilitate their breeding. Though they spend most of their life on land, they give birth to their young in water. They subsist mostly on a diet of insects, spiders, slugs, and worms. Fire salamanders can grow up to a foot in length, and in captivity, may live as long as 50 years.

The fire salamander’s numbers have been reduced by destruction of their forest habitat and capture for the pet trade, but the greatest threat is the susceptibility of their moisture-permeable skin to pollutants and microbes. Since 2014, they have become extinct in parts of the Netherlands and Belgium due to an introduced fungus.

Many of the animals on O’Reilly covers are endangered; all of them are important to the world. To learn more about how you can help, go to animals.oreilly.com.

The cover image is from *Wood’s Illustrated Natural History*. The cover fonts are URW Typewriter and Guardian Sans. The text font is Adobe Minion Pro; the heading font is Adobe Myriad Condensed; and the code font is Dalton Maag’s Ubuntu Mono.